

UNCLASSIFIED

FM 30-51

WAR DEPARTMENT

BASIC FIELD MANUAL



MILITARY INTELLIGENCE

IDENTIFICATION OF
BRITISH NAVAL SHIPS

December 29, 1941

REGRADED UNCLASSIFIED BY
AUTHORITY OF DOD DIR. 5200.1 R
BY RAM/SJG ON 0241906

FM 30-51

BASIC FIELD MANUAL

MILITARY INTELLIGENCE

**IDENTIFICATION OF
BRITISH NAVAL SHIPS**

**Prepared under direction of the
Chief of Staff**



**UNITED STATES
GOVERNMENT PRINTING OFFICE
WASHINGTON : 1942**

WAR DEPARTMENT,
WASHINGTON, December 29, 1941.

FM 30-51, Military Intelligence, Identification of British Naval Ships, is published for the information and guidance of all concerned.

[A. G. 062.11 (11-14-41).]

BY ORDER OF THE SECRETARY OF WAR:

G. C. MARSHALL,
Chief of Staff.

OFFICIAL:

E. S. ADAMS,
Major General,
The Adjutant General.

DISTRIBUTION:

R and H 1 (10), 4 (3); I Bn 1 (15), 4 (5); I C 4 (5).
(For explanation of symbols see FM 21-6.)

TABLE OF CONTENTS

	Paragraph	Page
SECTION I. General.		
Purpose-----	1	1
Scope-----	2	1
Observation of distinctive features-----	3	2
II. British Royal Navy.		14
Battleships-----		15
Battle cruisers-----		35
Aircraft carriers-----		39
Cruisers-----		59
Antiaircraft ships-----		119
Mine layers-----		127
Destroyers-----		133
Light destroyers-----		174
Torpedo boats-----		175
Power boats-----		178
Submarines-----		179
Escort vessels-----		190
Patrol vessels-----		198
Minesweepers-----		201
Motor minesweepers-----		204
Training ships-----		205
Monitors-----		207
Training aircraft carriers-----		209
Submarine tenders-----		212
III. Royal Australian Navy.		213
Cruisers-----		215
Escort vessels-----		226
Destroyers-----		227
IV. Royal Indian Navy.		230
Escort vessels-----		231
V. Royal Canadian Navy.		235
Destroyers-----		236
VI. New Zealand Navy.		241
Cruisers-----		243
INDEX TO SHIPS-----		247

BASIC FIELD MANUAL
MILITARY INTELLIGENCE
IDENTIFICATION OF BRITISH NAVAL SHIPS

SECTION I

GENERAL

- 1. **PURPOSE.**—The purpose of this manual is to serve as a guide in the identification of naval ships of the British Empire. It is the best available, though incomplete.
- 2. **SCOPE.**—This manual, containing illustrations with explanatory data relative to naval ships of the British Empire, is published for limited distribution. When illustrations are not given, blank spaces have been left so that they may be added when provided.

MILITARY INTELLIGENCE

■ 3. OBSERVATION OF DISTINCTIVE FEATURES.—*a.* Observers must be able to detect quickly and analyze rapidly every possible indication of identity of naval ships. Some characteristic visible features of individual ships generally indicative of the class and, when noted in sufficient detail, of the particular ship are—

General shape and size.

Bow and stern.

Funnels and cinder screens.

Masts and decks.

Superstructure:

Bridge, and navigation bridge.

Chart house and compass platform.

Directional aerial.

Tower, control towers, and conning tower.

Searchlights.

Primary and secondary armament.

Torpedo tubes.

Planes, catapults, cranes, derricks, and hangars.

b. Figures 1 to 9, inclusive, illustrate characteristic features of warships and show the location of armor protection.

c. Flags of the British Navy are illustrated in figure 10, and insignia of rank worn on sleeves of naval officers are shown in figure 11.

IDENTIFICATION OF BRITISH NAVAL SHIPS

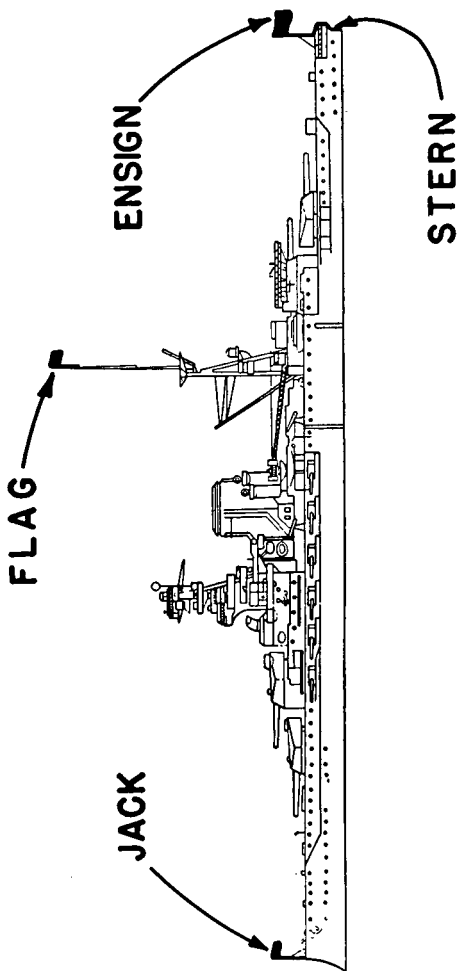

FIGURE 1.—Outstanding features of warship.

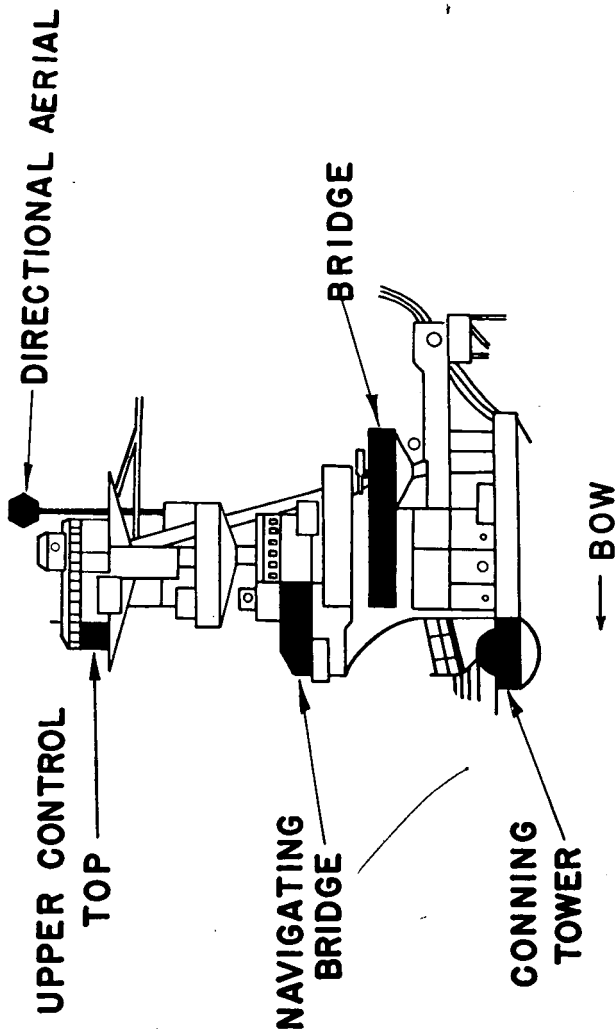

FIGURE 2.—Forebridge and foremast.

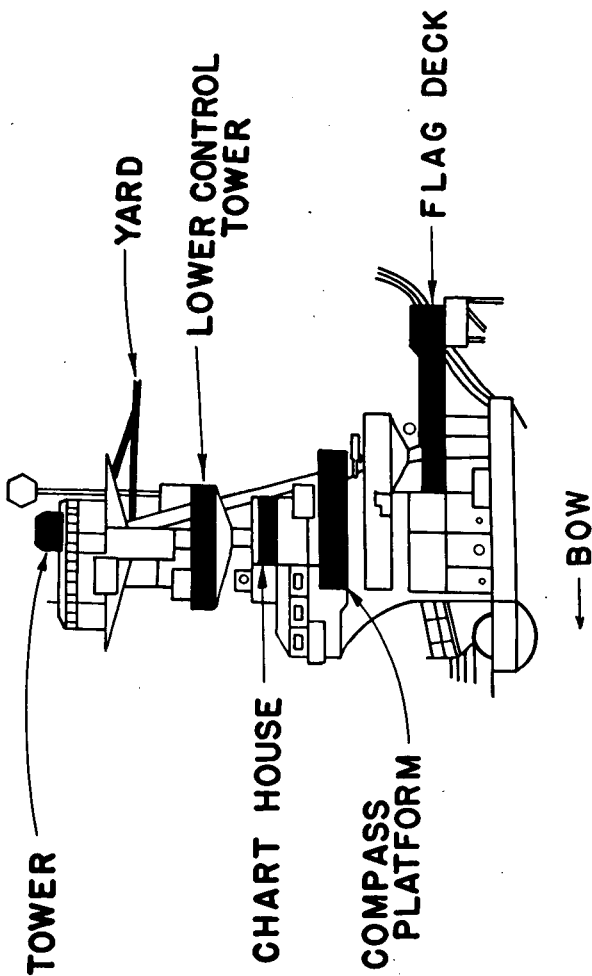

FIGURE 3.—Forebridge and foremast.

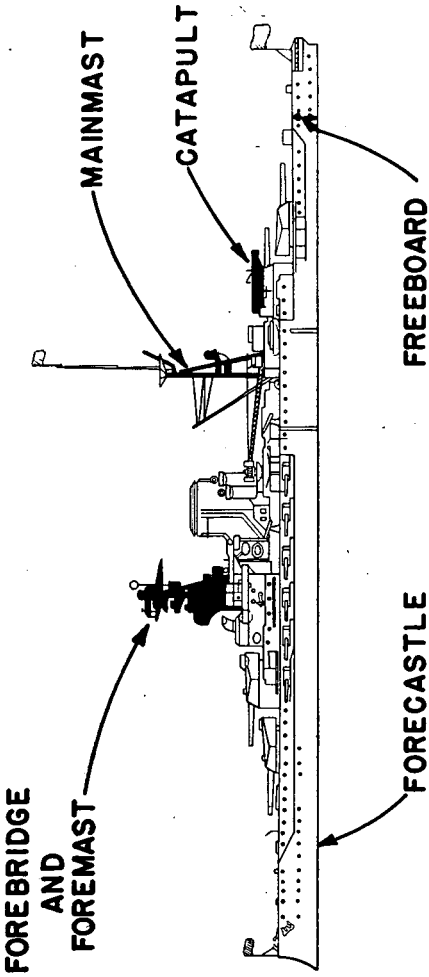

FIGURE 4.—Outstanding features of warship.

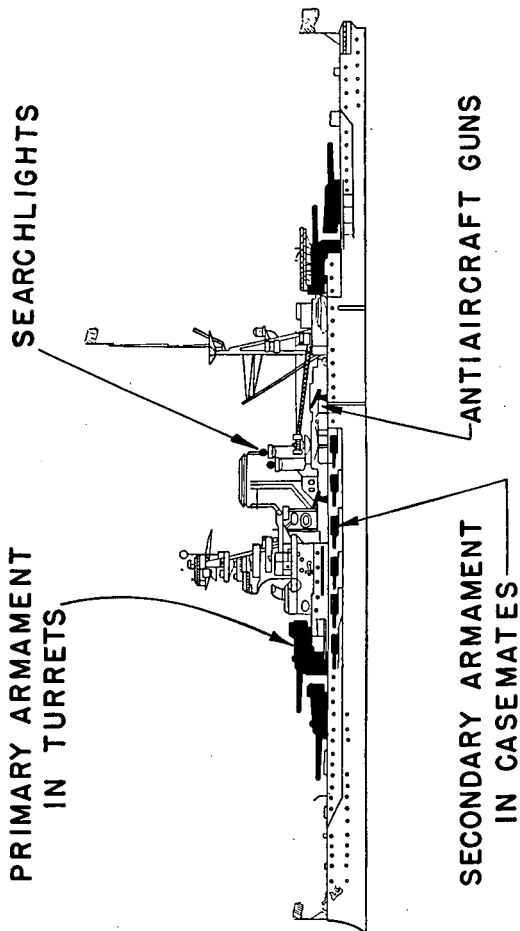

FIGURE 5.—Outstanding features of warship.

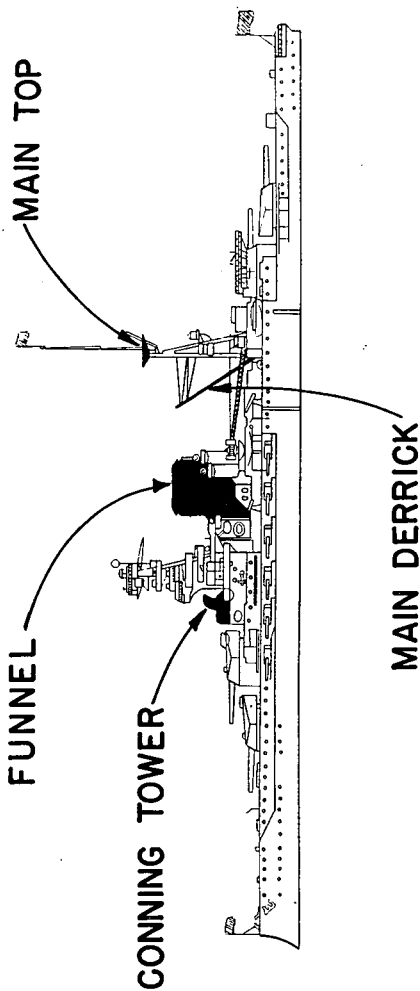

FIGURE 6.—Outstanding features of warship.

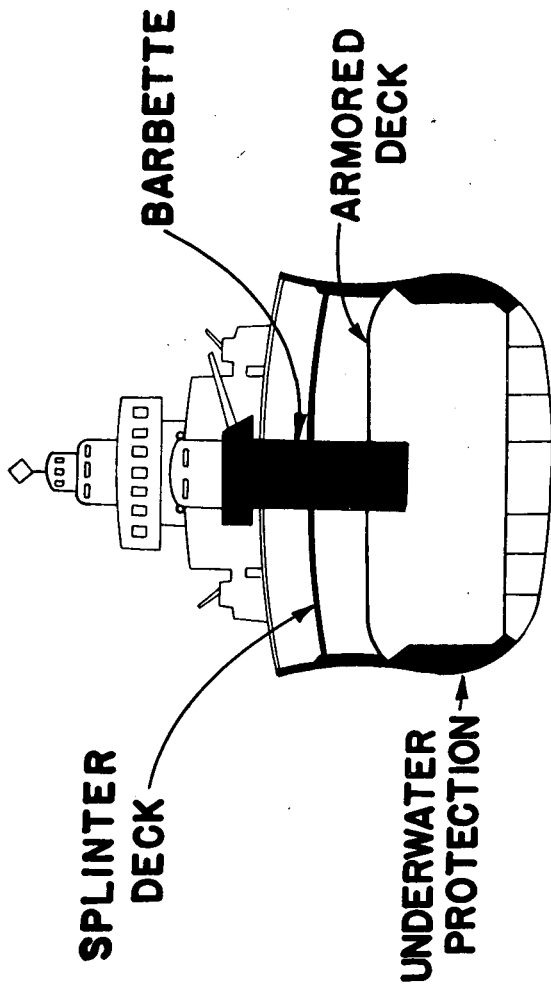

FIGURE 7.—Armor protection (cross section of hull through barrette).

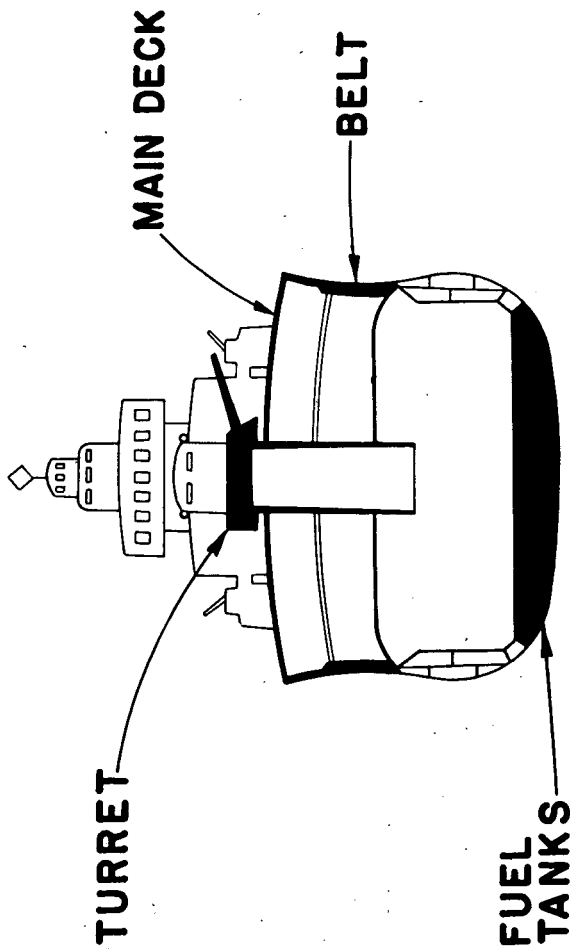

FIGURE 8.—Armor protection (cross section of hull through barbettes).

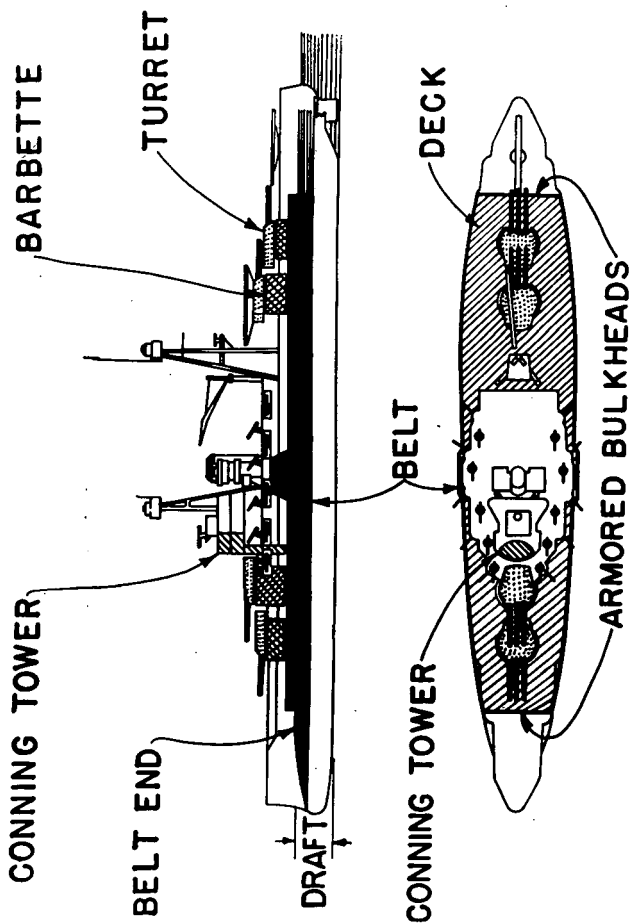

FIGURE 9.—Battleship armor.

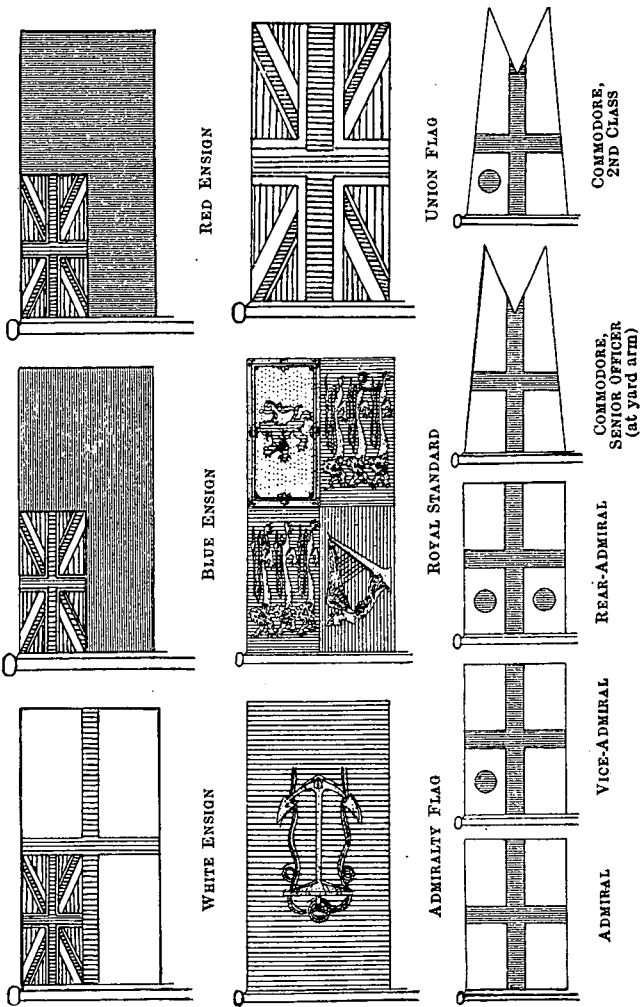

FIGURE 10.—Flags of British Navy.

IDENTIFICATION OF BRITISH NAVAL SHIPS

Admiral of the Fleet	
Admiral	
Vice-Admiral	
Rear-Admiral or Commodore (1st class)	
Commodore (2nd Class)	
Captain	
Commander	
Lieutenant-Commander	
Lieutenant	
Sub-Lieutenant or Commissioned Warrant Officer	
Warrant Officer	

Relative Ranks, Non-Executive Branches.
 Engineer Officers have same as above, with purple between stripes

Medical	"	"	scarlet
Dental	"	"	orange
Accountant	"	"	white
Instructor	"	"	light blue
Shipwright	"	"	silver gray
Wardmaster	"	"	maroon
Electrical	"	"	dark green
Ordnance	"	"	dark blue

FIGURE 11.—Insignia of rank on sleeves of naval officers.

MILITARY INTELLIGENCE

SECTION II

BRITISH ROYAL NAVY



Battleship KING GEORGE V.

Battleships
King George V Class

King George V Class
(5 ships)

KING GEORGE V
PRINCE OF WALES
DUKE OF YORK
(JELLICOE) renamed ANSON
(BEATTY) renamed HOWE

Description: Displacement: 35,000 tons.
Length: 740 feet.
Beam: 103 feet.
Draft: 28 feet (mean).
Speed: Over 30 knots.

Guns: 10—14-inch.
16—5.25-inch.
4—Multiple pompoms.
Several smaller.

Torpedo tubes: None.

Aircraft: 4 Catapults: 1

Gunnery note: 14-inch guns are a new model, with an effective range greater than the 15-inch mounted in earlier ships.

BRITISH NAVY

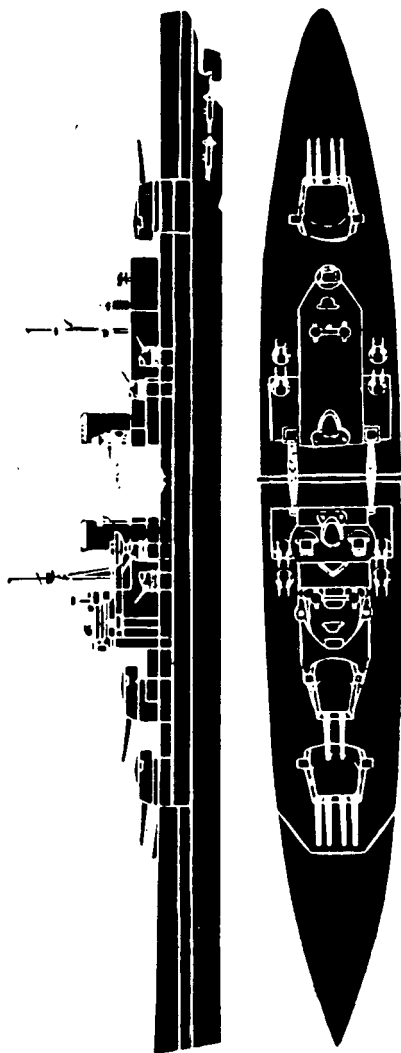

King George V Class.

IDENTIFICATION OF BRITISH NAVAL SHIPS

Battleships
King George V Class

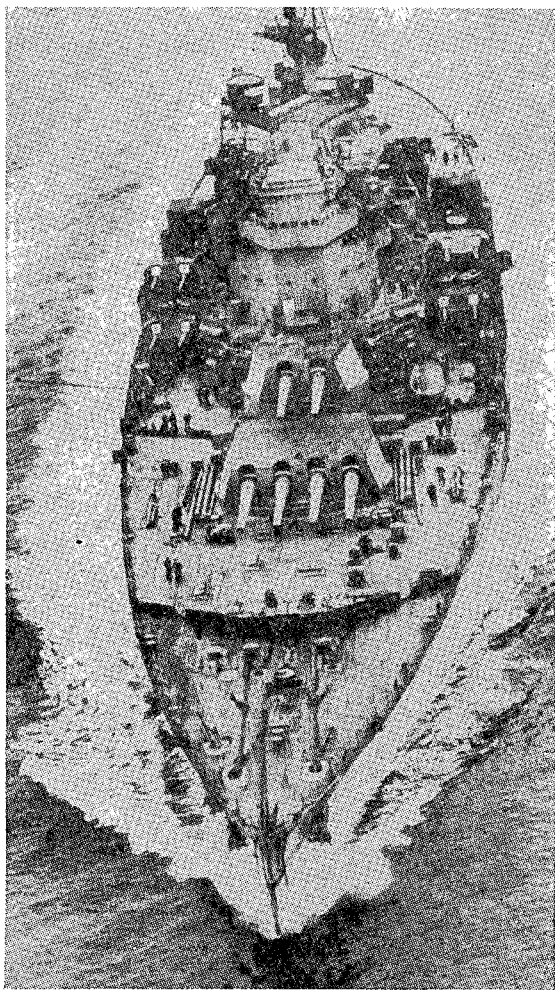

Battleship KING GEORGE V.

BRITISH NAVY

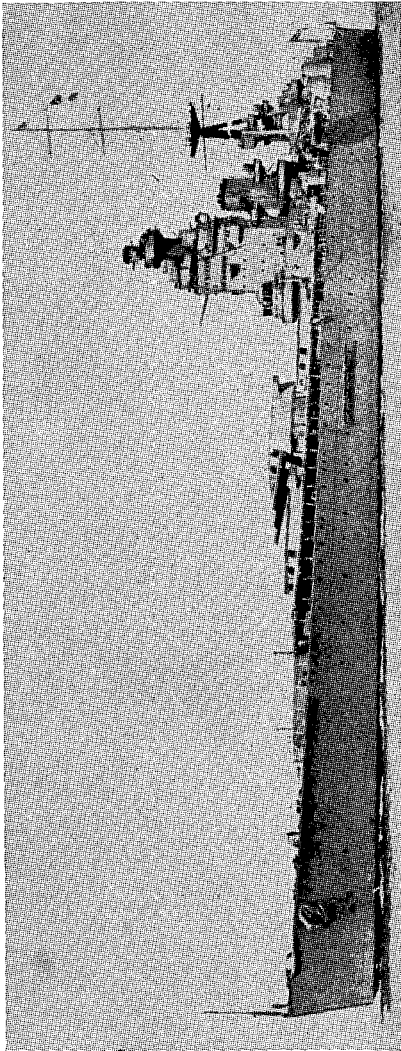

Battleship NELSON.

IDENTIFICATION OF BRITISH NAVAL SHIPS

Battleships
Nelson Class

Nelson Class
(2 ships)

NELSON (33,950 tons)

RODNEY (33,900 tons)

Description: Displacement: As above.
Length: 710 feet (over-all).
Beam: 106 feet.
Draft: 30 feet (mean).
Speed: 23 knots.

Guns: 9—16-inch.

12—6-inch.

6—4.7-inch AA.

4—3-pounder.

18 smaller (including 3 multiple pompoms).

Torpedo tubes (submerged): 2—24.5-inch.

Aircraft: Rodney 2—Catapult on "C" turret.

Nelson 1—Handled by crane.

BRITISH NAVY

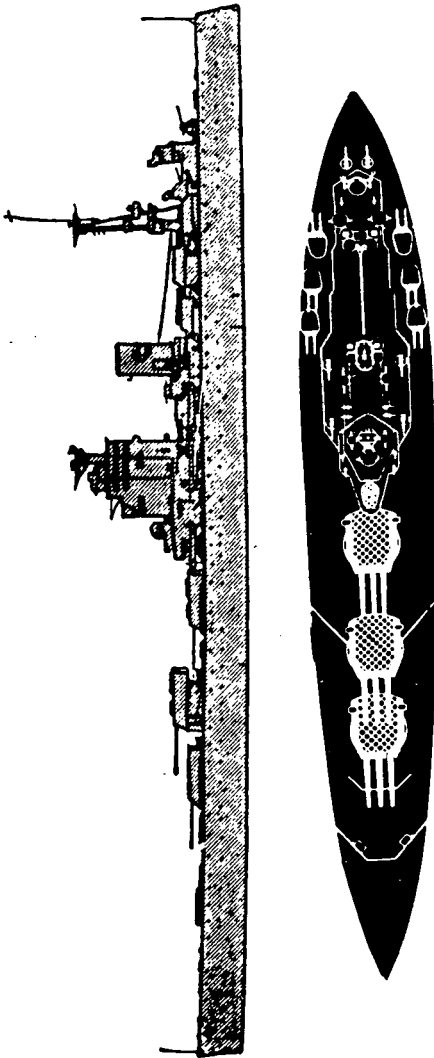

Battleship NELSON.

(RODNEY similar, but with catapult on "C" turret; foretops differ slightly.)

IDENTIFICATION OF BRITISH NAVAL SHIPS

Battleships
Nelson Class

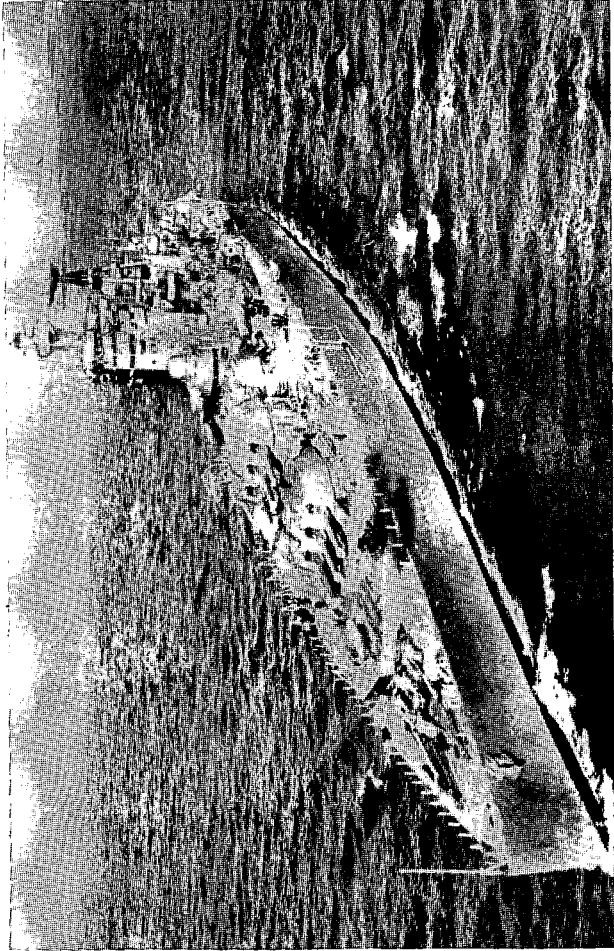

Battleship NELSON.

BRITISH NAVY

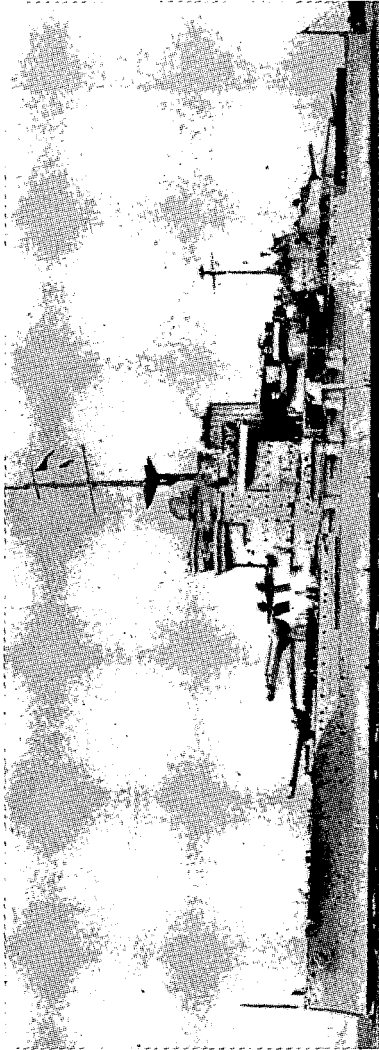

Battleship WARSPITE.

IDENTIFICATION OF BRITISH NAVAL SHIPS

Battleships
Queen Elizabeth Class
(1st 3 ships)

QUEEN ELIZABETH
WARSPITE
VALIANT

Description: Displacement: 35,000 tons (full load).
Length: 643 $\frac{3}{4}$ feet (over-all).
(VALIANT 639 $\frac{3}{4}$ feet.)
Beam: 104 feet.
Draft: 33 $\frac{1}{2}$ feet (maximum).
Speed: 24 knots.

Guns: 8—15-inch.
12—6-inch (WARSPITE 8—6-inch).
8—4-inch AA.
4—3-pounder.
5—machine guns.
10—Lewis guns (besides multimachine guns).

Aircraft: 4. Catapults: 1.

Appearance note: As rebuilt, above 3 ships differ completely from former appearance, as will be seen by comparison of WARSPITE with MALAYA.

BRITISH NAVY

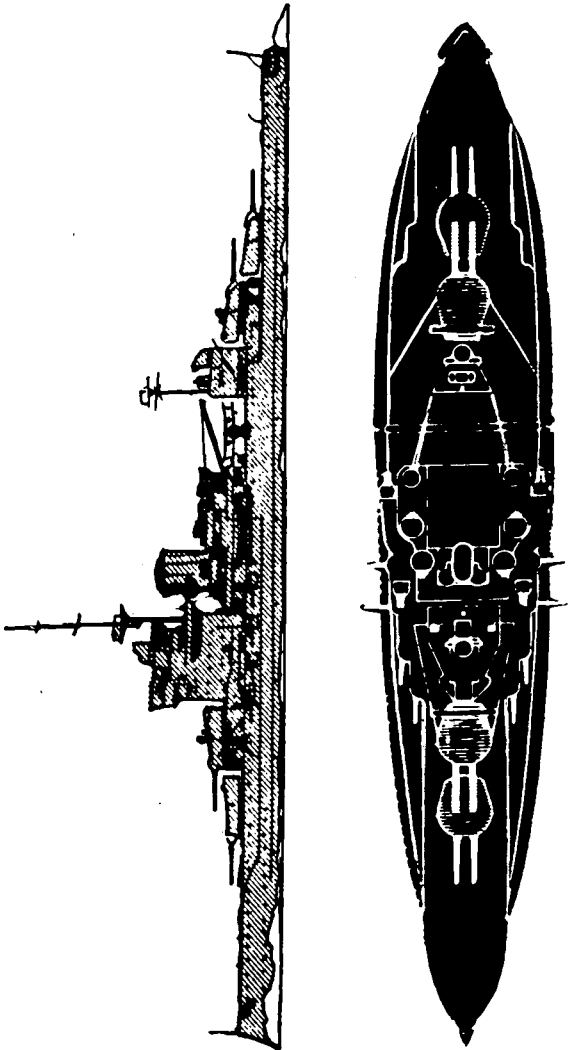

Battleship WARSPITE (QUEEN ELIZABETH and VALIANT similar).

IDENTIFICATION OF BRITISH NAVAL SHIPS

Battleships
Queen Elizabeth Class
(1st 3 ships)

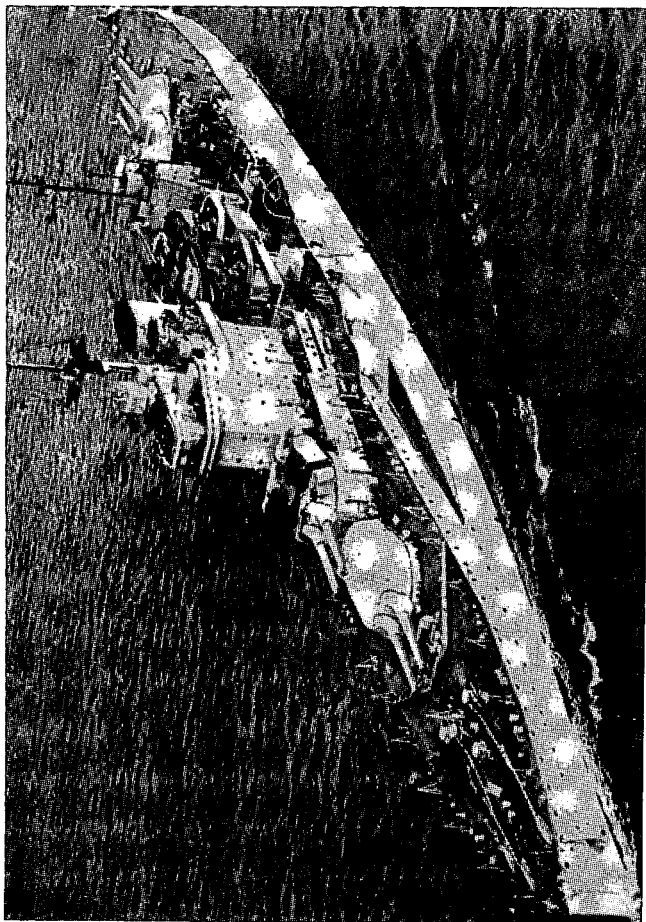

Battleship WARSPITE.

BRITISH NAVY

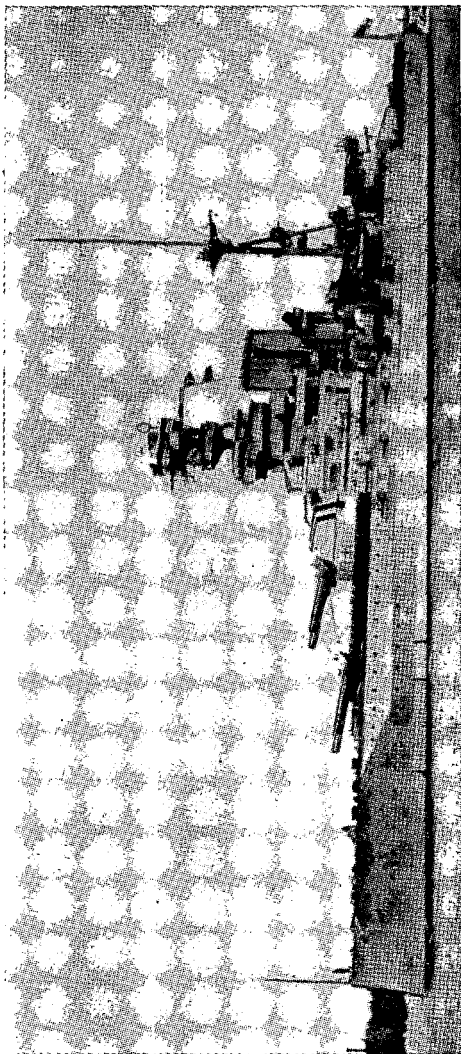

Battleship BARHAM.

IDENTIFICATION OF BRITISH NAVAL SHIPS

Battleships
Queen Elizabeth Class
(4th and 5th ships)

BARHAM
MALAYA

Description: Displacement: 35,100 tons (full load).
Length: BARHAM—643 $\frac{3}{4}$ feet (over-all).
MALAYA—639 $\frac{3}{4}$ feet (overall).
Beam: 104 feet.
Draft: 33 $\frac{1}{2}$ feet (maximum).
Speed: 25 knots (reduced by fitting of bulges).

Guns: 8—15-inch.
12—6-inch.
8—4-inch AA.
4—3-pounder.
5—machine guns.
10—Lewis guns (besides multimachine guns).

Torpedo tubes: 2—21-inch in BARHAM.

Aircraft: 1 in BARHAM. Catapults: 1.
4 in MALAYA.

Appearance note: BARHAM has tripod mainmast and catapult on roof of "X" turret; MALAYA has pole mainmast and new type (athwartship) catapult before mainmast.

BRITISH NAVY

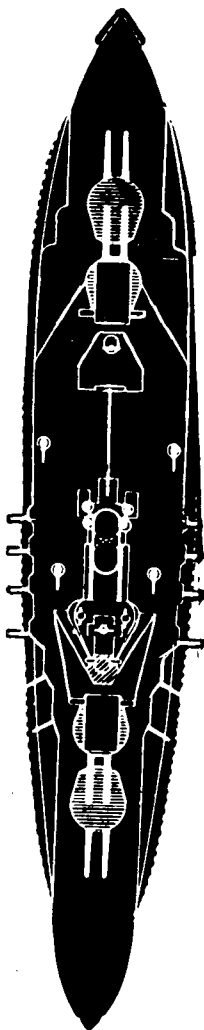
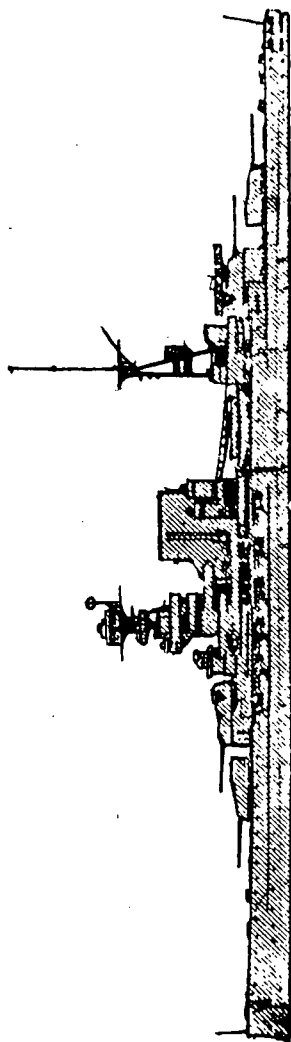

Battleship BARHAM (MALAYA similar).
(Now has athwartship catapult and 4-inch AA guns are paired.)

IDENTIFICATION OF BRITISH NAVAL SHIPS

Battleships
Queen Elizabeth Class
(4th and 5th ships)

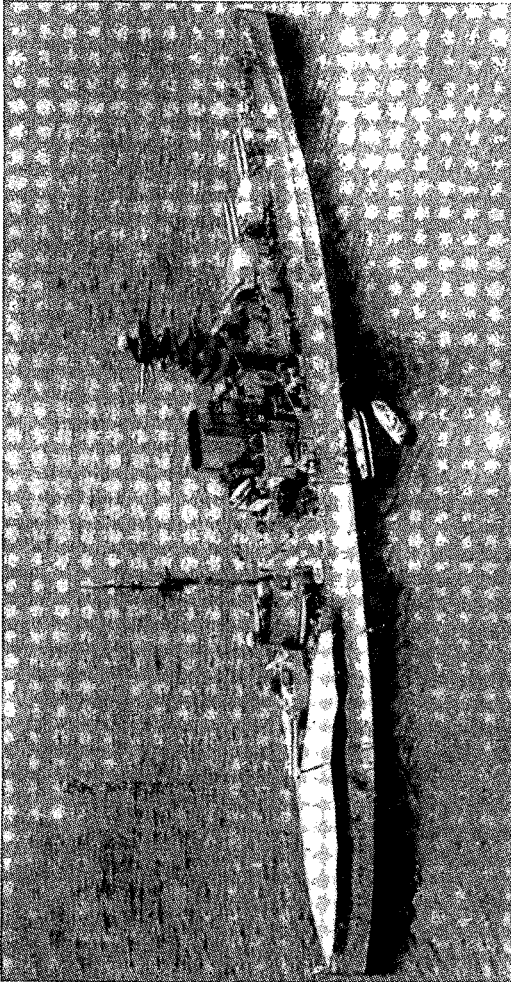

Battleship MALAYA.

BRITISH NAVY

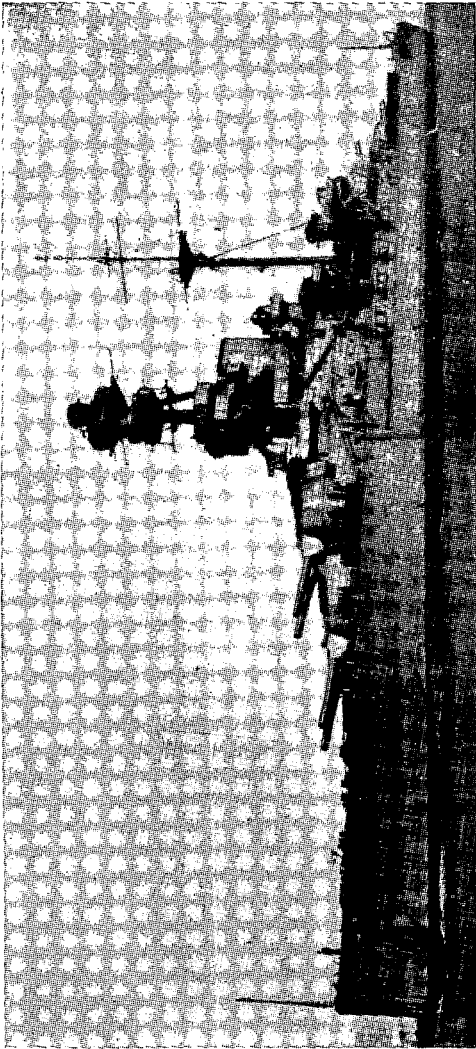

Battleship ROYAL SOVEREIGN.

Battleships
Royal Sovereign Class

Royal Sovereign Class

ROYAL SOVEREIGN

RESOLUTION

RAMILLIES

REVENGE

Description: Displacement: 33,500 tons (full load).

Length: 620½ feet (over-all).

Beam: 102½ feet.

Draft: 28½ feet (mean).

Speed: under 22 knots with bulges.

Guns: 8—15-inch.	1—12-pounder, field.
12—6-inch.	5 machine guns.
8—4-inch.	10 Lewis (besides multi-
4—3-pounder.	machine guns).

Torpedo tubes: 2—21-inch (submerged in REVENGE).

Aircraft: 1 on RESOLUTION.

Catapults: 1 on RESOLUTION (turret type).

Appearance note: RESOLUTION has clinker screen to funnel, tripod mainmast, and catapult on "X" turret. ROYAL SOVEREIGN retains pole mainmast and has very tall charthouse. RAMILLIES has deep bulges, extending up to battery, and tripod mainmast. REVENGE has pole mainmast with searchlight platform and short topmast, clinker screen to funnel, sternwalk, and extra heavy forebridge. Details of bridge vary in each ship.

MILITARY INTELLIGENCE

BRITISH NAVY

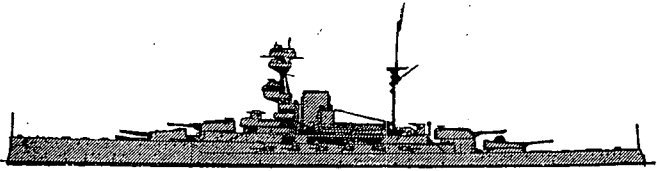

ROYAL SOVEREIGN

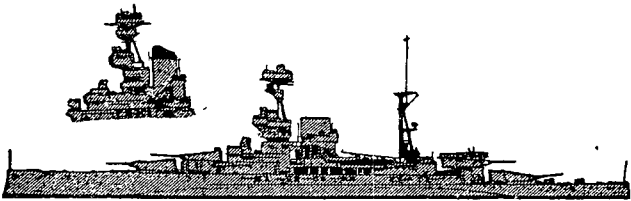

RAMILLIES (Part sketch—RESOLUTION; only RESOLUTION has catapult on "X" turret.)

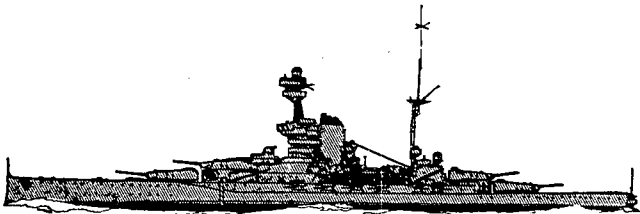

REVENGE

Battleships
Royal Sovereign Class

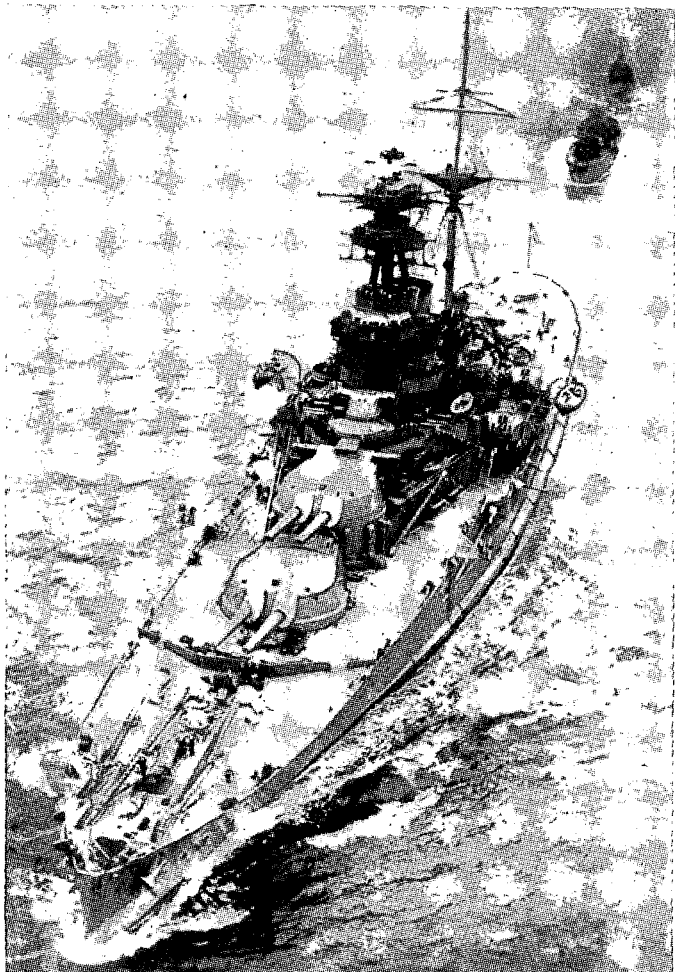

Battleship ROYAL SOVEREIGN.

BRITISH NAVY

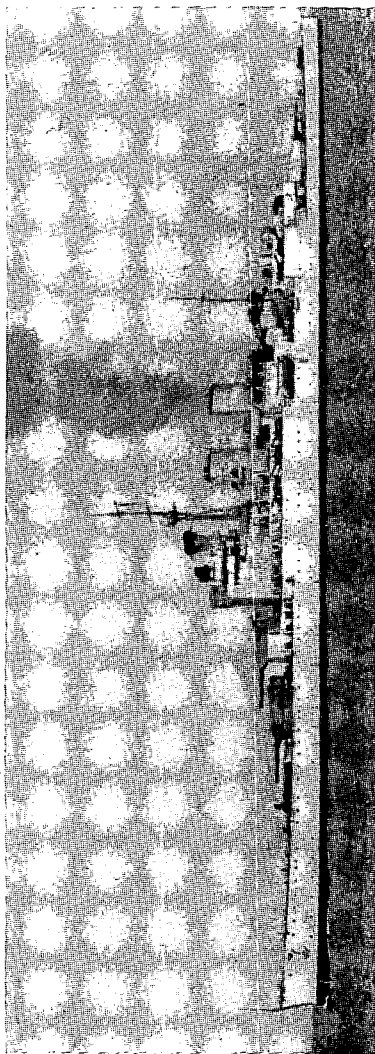

Battle cruiser RENOWN.

Battle Cruisers
Renown Class

Renown Class

RENOWN (37,400 tons (full load))

REPULSE (36,800 tons (full load))

Description: Displacement: As above.
Length: 794 feet (over-all).
Beam: 103 feet.
Draft: 27 feet (mean).
Speed: 29 knots.

RENOWN

Guns: 6—15-inch.
20—4.5-inch (dual purpose).
18 smaller.

Torpedo tubes: None.

Aircraft: 4 with catapult.

REPULSE

Guns: 6—15-inch.
12—4-inch.
8—4-inch AA.
4—3-pounder.
1—12-pounder, field.
5 machine guns.
10 Lewis (besides multimachine guns).

Torpedo tubes: 8—21-inch above water in pairs.

Aircraft: 4 with catapult.

BRITISH NAVY

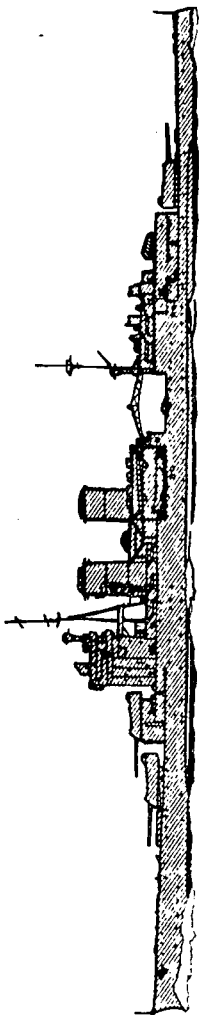

Battle cruiser RENOWN.

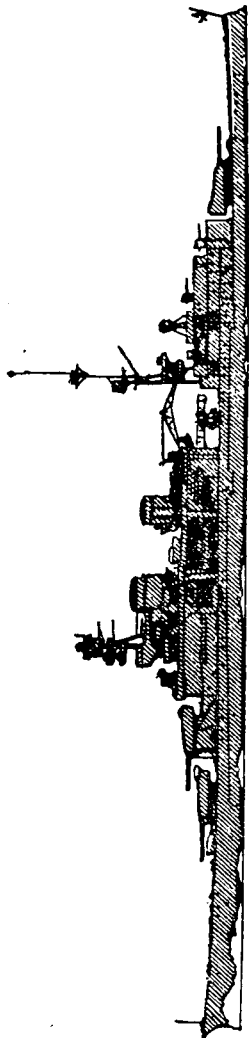

Battle cruiser REPULSE.

Battle Cruisers
Renown Class

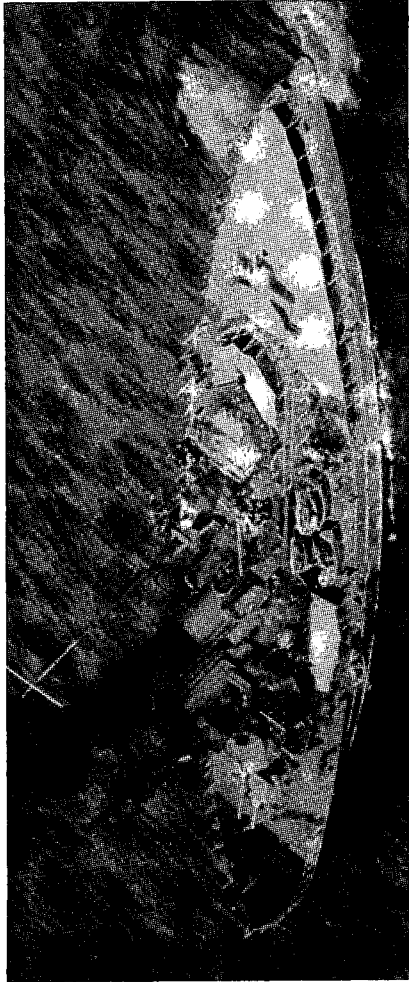
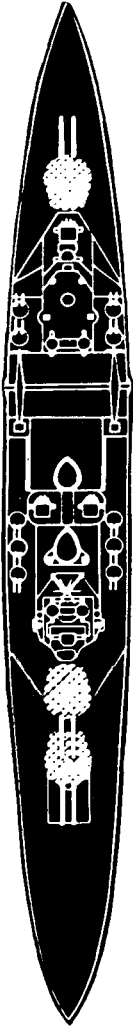

Battle cruiser REPULSE.

BRITISH NAVY

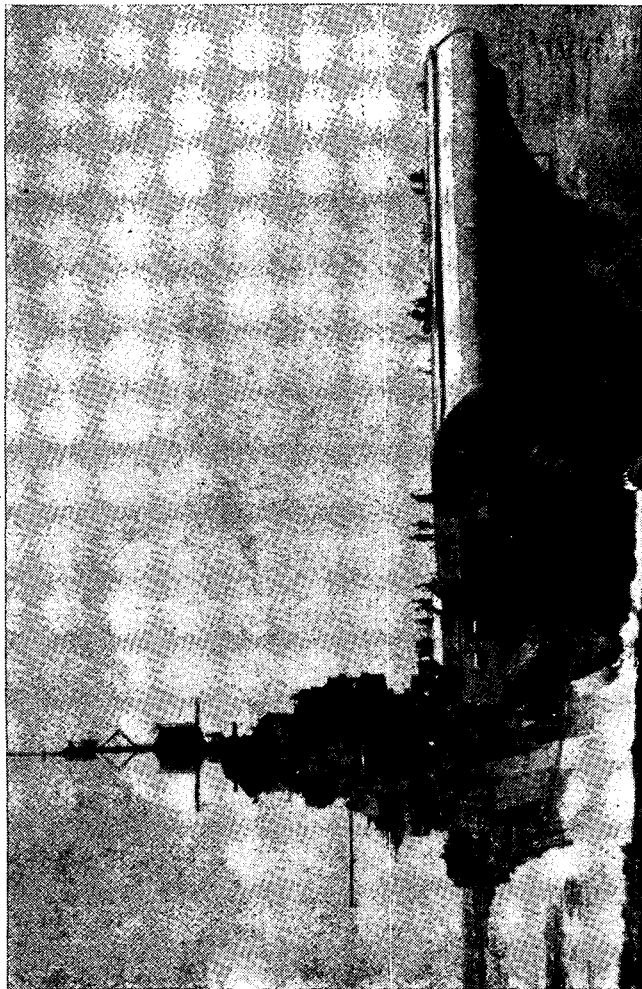

Aircraft carrier ILLUSTRIOUS.

IDENTIFICATION OF BRITISH NAVAL SHIPS

Aircraft Carriers
Illustrious Class
(6 ships)

Illustrious Class

ILLUSTRIOUS
VICTORIOUS
FORMIDABLE
INDOMITABLE
IMPLACABLE
INDEFATIGABLE

Description: Displacement: 23,000 tons.

Length: 753 feet.

Beam: 95 feet.

Draft: 24 feet.

Speed: Over 30 knots.

Guns: 16—4.5-inch (dual purpose).

MILITARY INTELLIGENCE

BRITISH NAVY

Aircraft Carriers
Illustrious Class

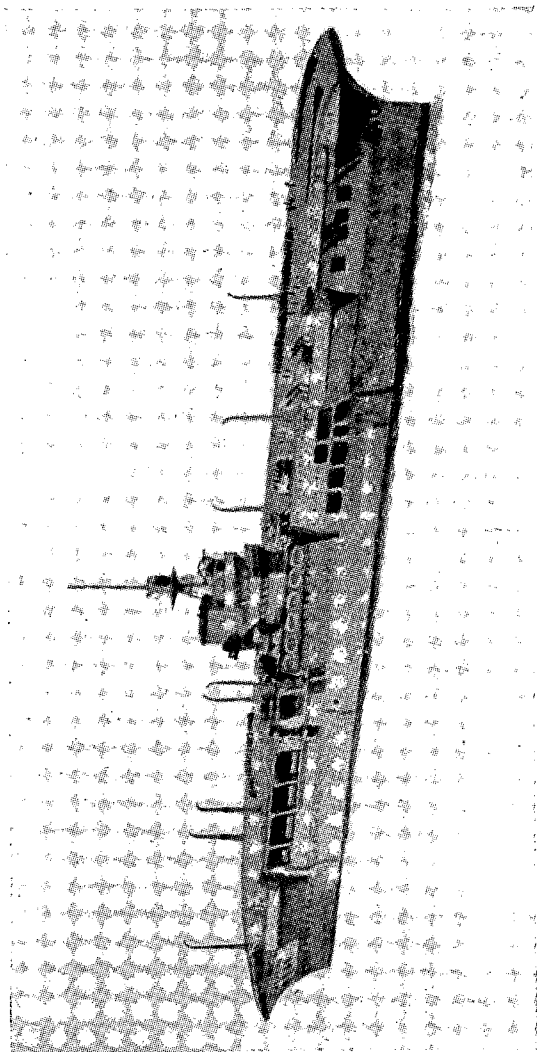

Aircraft carrier ILLUSTRIOUS.

BRITISH NAVY

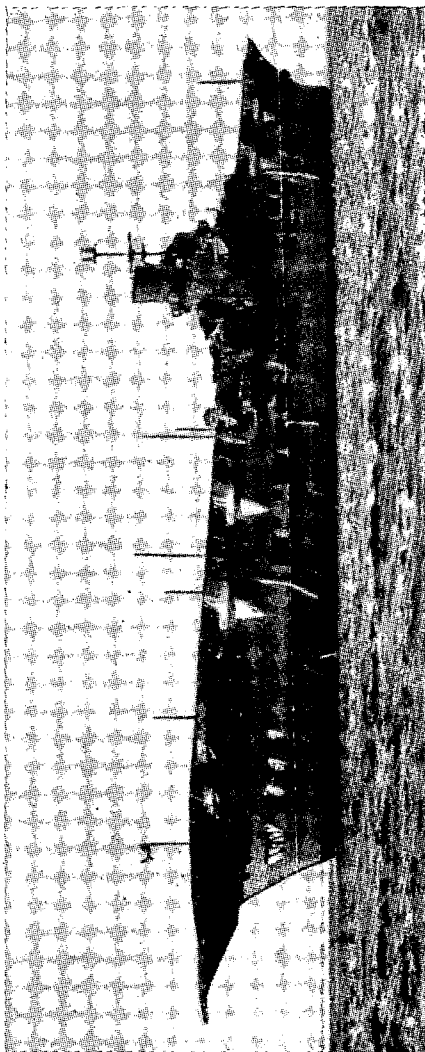

Aircraft carrier ARK ROYAL

Aircraft Carrier
ARK ROYAL

ARK ROYAL

Description: Displacement: 27,000 tons (full load).

Length: 800 feet (over-all).

Beam: 94 $\frac{3}{4}$ feet.

Draft: 23 feet (mean).

Speed: 31 knots.

Guns: 16—4.5-inch (dual purpose).

4—3-pounder.

6 multiple pompoms.

8 multimachine guns.

Aircraft: 60.

BRITISH NAVY



Aircraft carrier ARK ROYAL.
(Funnel since heightened.)

Aircraft Carrier
ARK ROYAL



Aircraft carrier ARK ROYAL.

BRITISH NAVY

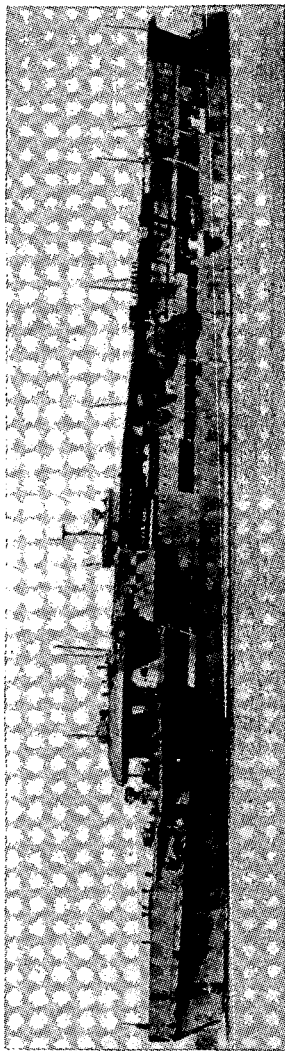

Aircraft carrier FURIOUS.

Aircraft Carrier
FURIOUS

FURIOUS

Description: Displacement: 22,450 tons.
Length: 786 $\frac{1}{4}$ feet (over-all).
Beam: 89 $\frac{3}{4}$ feet (outside bulges).
Draft: 25 feet (maximum).
Speed: 31 knots.

Guns: 12—4.5-inch (dual purpose).
8 multiple pompoms.
22 smaller.

Aircraft: 33 (official complement).

BRITISH NAVY

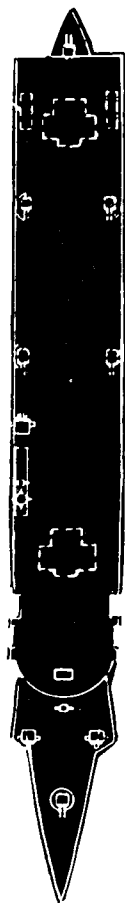
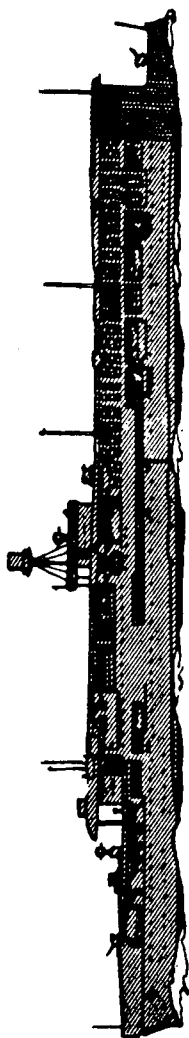

Aircraft carrier FURIOUS.

Aircraft Carrier
FURIOUS

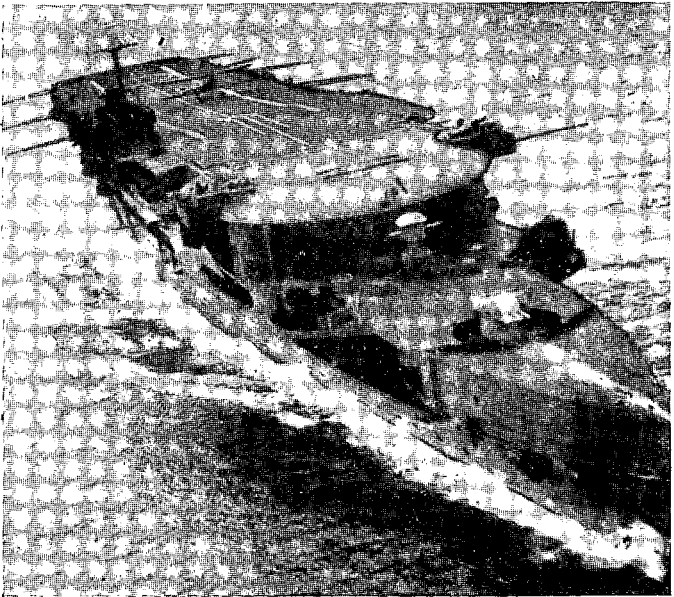

Aircraft carrier FURIOUS.

BRITISH NAVY

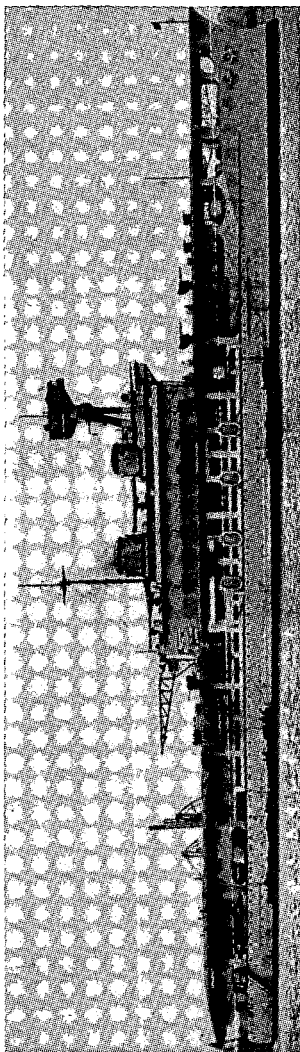

Aircraft carrier EAGLE.

Aircraft Carrier
EAGLE

EAGLE

Description: Displacement: 26,400 tons (deep load).

Length: 667 feet (over-all).

Beam: 105 feet (maximum).

Draft: 27 feet (maximum).

Speed: 24 knots.

Guns: 9—6-inch.

4—4-inch AA.

22 smaller.

Aircraft: 21 (official complement).

BRITISH NAVY

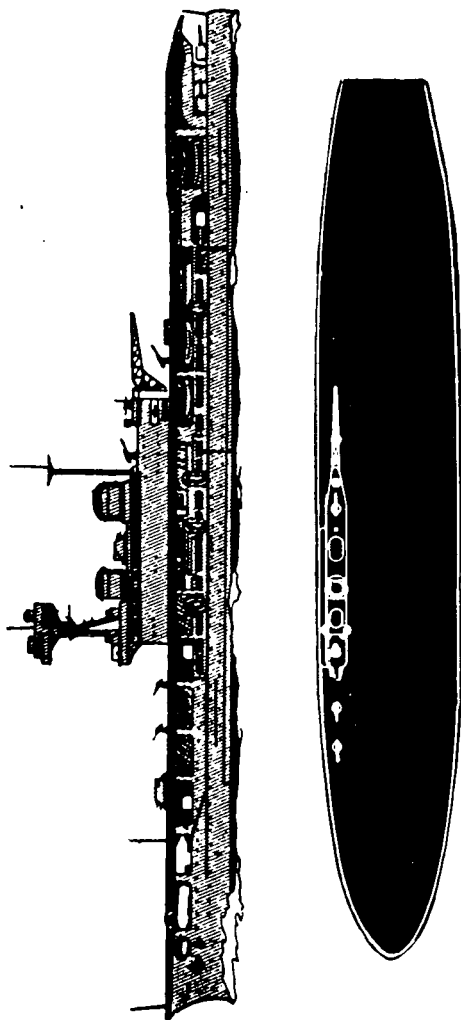

Aircraft carrier EAGLE.

Aircraft Carrier
EAGLE

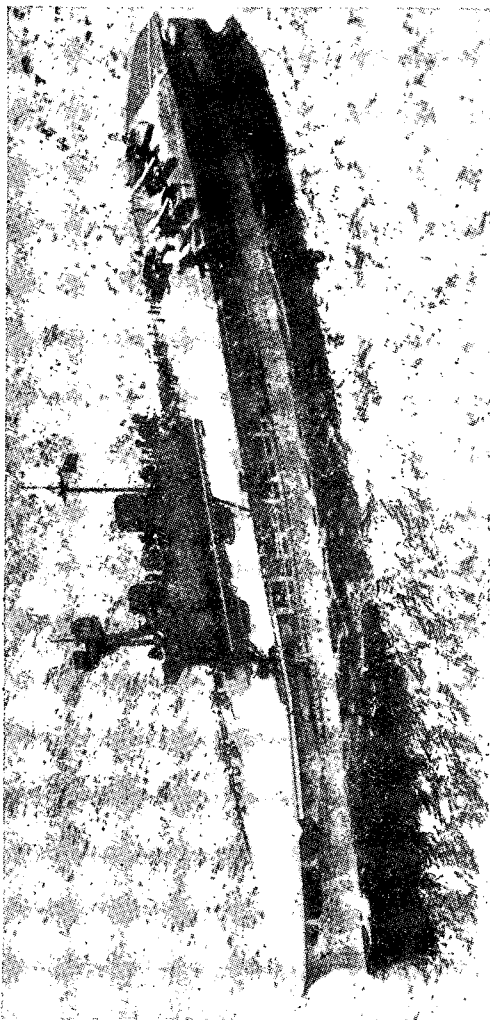

Aircraft carrier EAGLE.

BRITISH NAVY

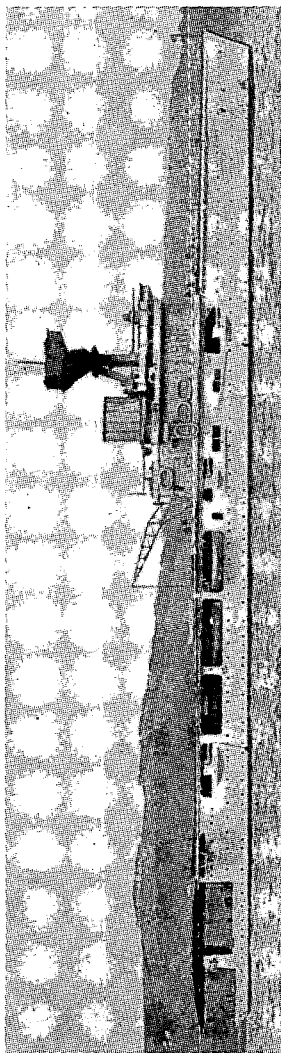

Aircraft carrier HERMES.

Aircraft Carrier
HERMES

HERMES

Description: Displacement: 12,900 tons (full load).

Length: 598 feet (over-all).

Beam: 70 feet (waterline).

90 feet (over flight deck).

Draft: $18\frac{3}{4}$ feet (mean).

Speed: 25 knots.

Guns: 6—5.5-inch.

3—4-inch AA.

18 smaller.

Aircraft: 15 (official complement).

BRITISH NAVY

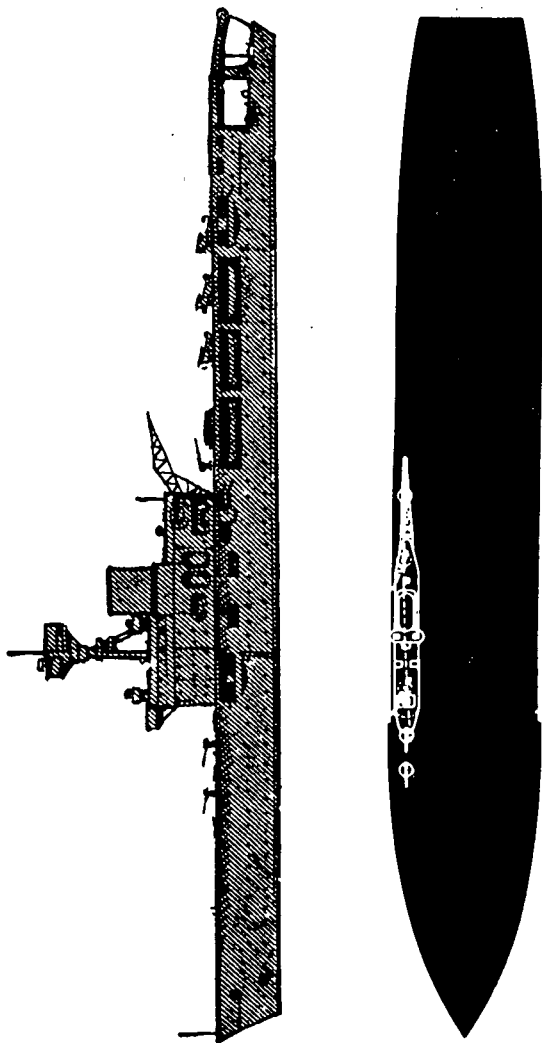

Aircraft carrier HERMES.

Aircraft Carrier
HERMES

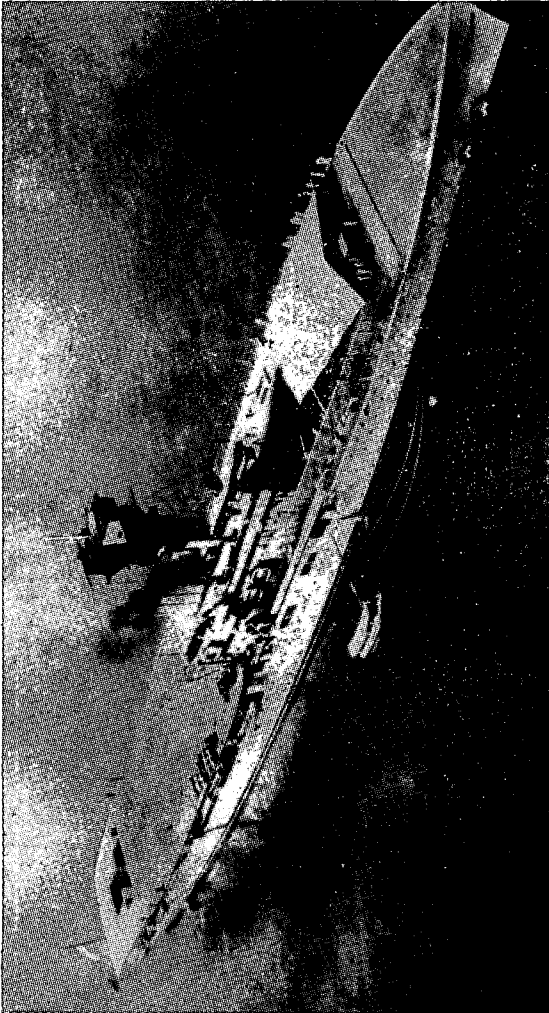

Aircraft carrier HERMES.

BRITISH NAVY

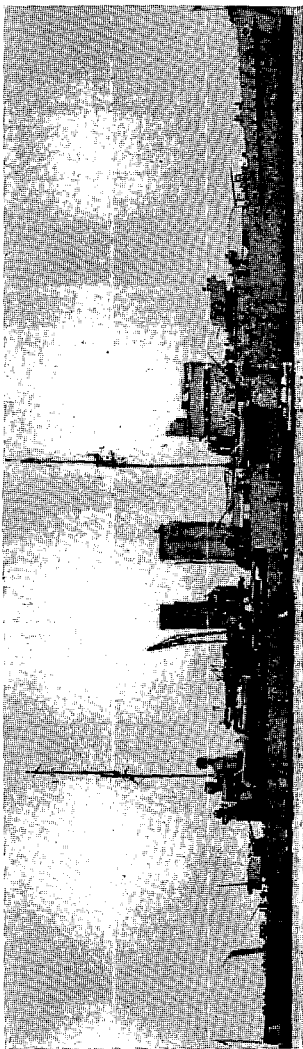

Cruiser EXETER.

EXETER

Description: Displacement: 8,390 tons.
Length: 575 feet (over-all).
Beam: 58 feet.
Draft: 17 feet (mean).
Speed: 32 knots.

Guns: 6—8-inch.
8—4-inch AA.
4—3-pounder.
14 smaller.

Torpedo tubes: 6—21-inch (tripled).

Aircraft: 2. Catapults: 2.

Appearance note: Design is similar to YORK.

BRITISH NAVY

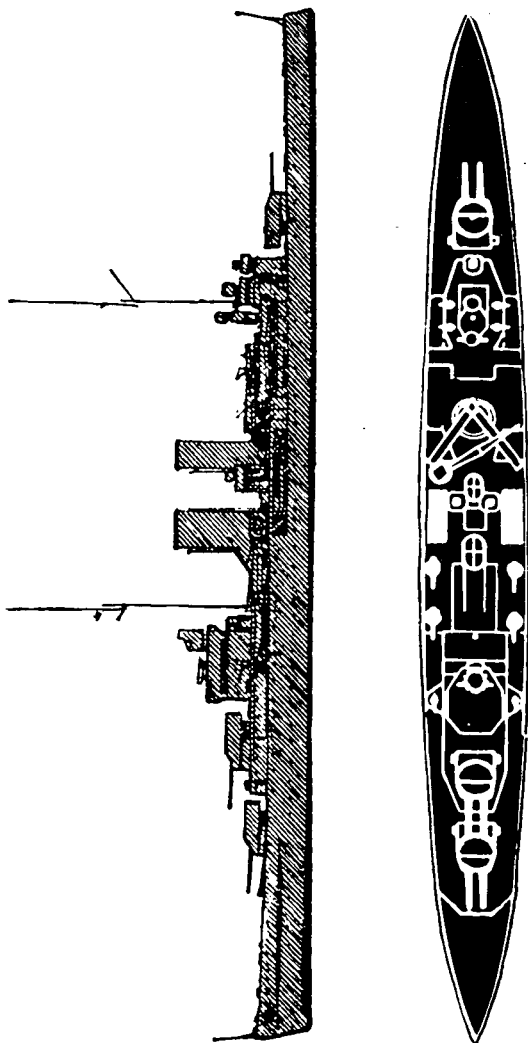

Cruiser EXETER.

(AA guns are now in pairs.)

IDENTIFICATION OF BRITISH NAVAL SHIPS

Cruiser
EXETER

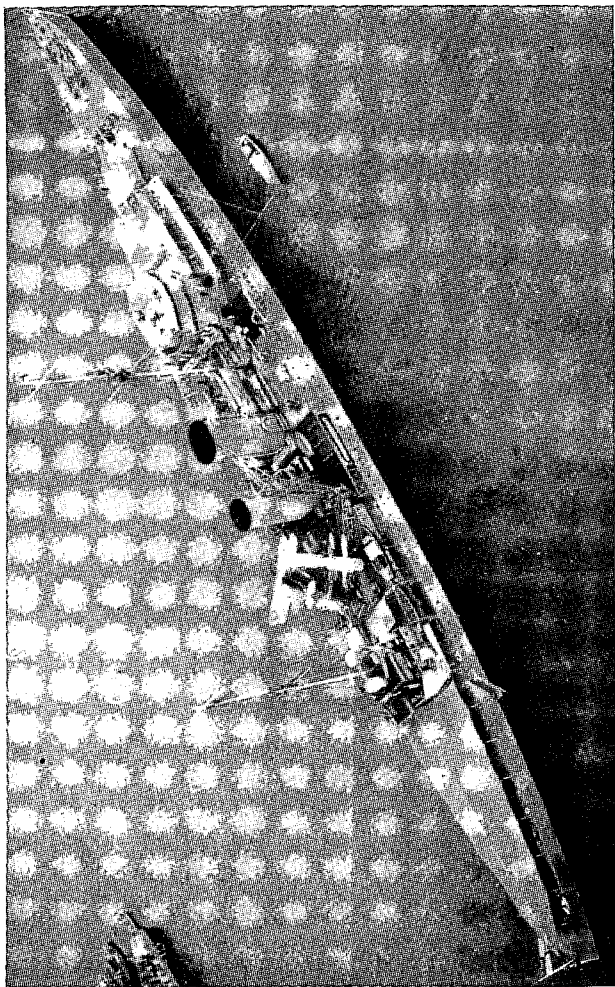

Cruiser EXETER.

BRITISH NAVY

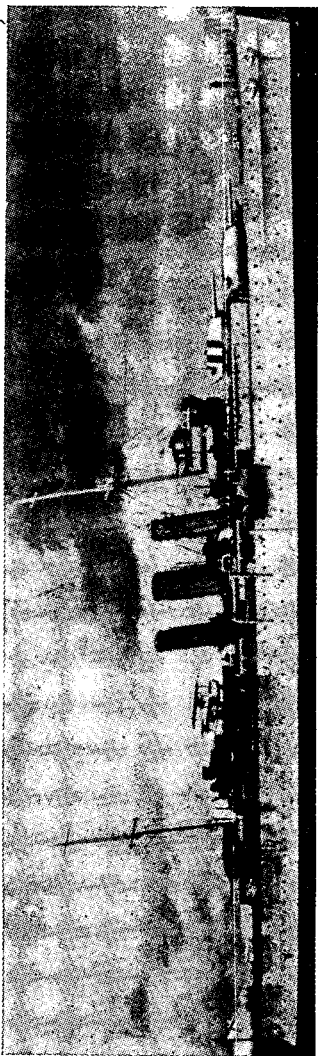

Cruiser DORSETSHIRE.

Cruiser
Dorsetshire Class

DORSETSHIRE
NORFOLK

Description: Displacement: 9,975 tons.
Length: 630 feet (over-all).
Beam: 66 feet.
Draft: 17 feet (mean).
Speed: 32 knots.

Guns: 8—8-inch.
8—4-inch AA.
4—3-pounder.
16 smaller.

Torpedo tubes: 8—21-inch (quadrupled).

Aircraft: 1. Catapults: 1.

Appearance note: Can be distinguished from London Class by lower bridge, positions of antiaircraft guns, and sternwalks; from KENT by absence of searchlight tower forward of mainmast; and from other ships of Kent Class by absence of hangar.

BRITISH NAVY

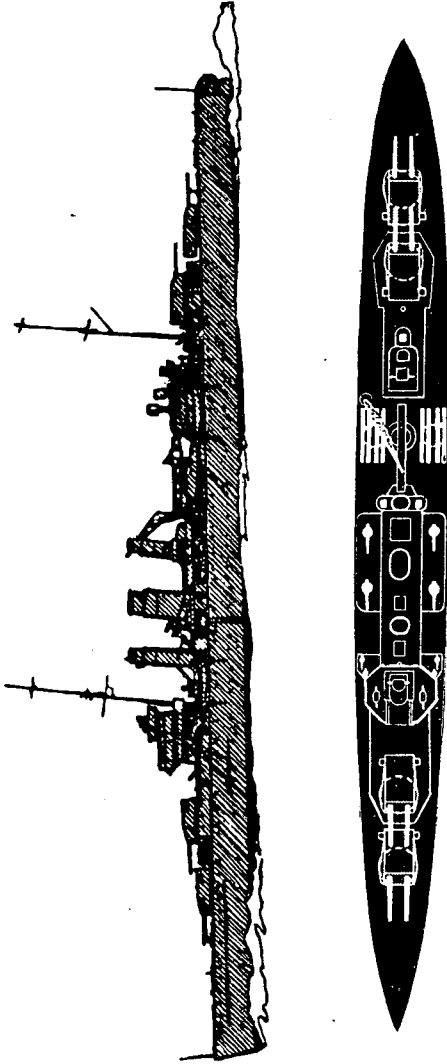

Cruisers, Dorsetshire Class.

(Crane is actually mounted forward of torpedo tubes; AA guns are paired.)

IDENTIFICATION OF BRITISH NAVAL SHIPS

Cruisers
Dorsetshire Class

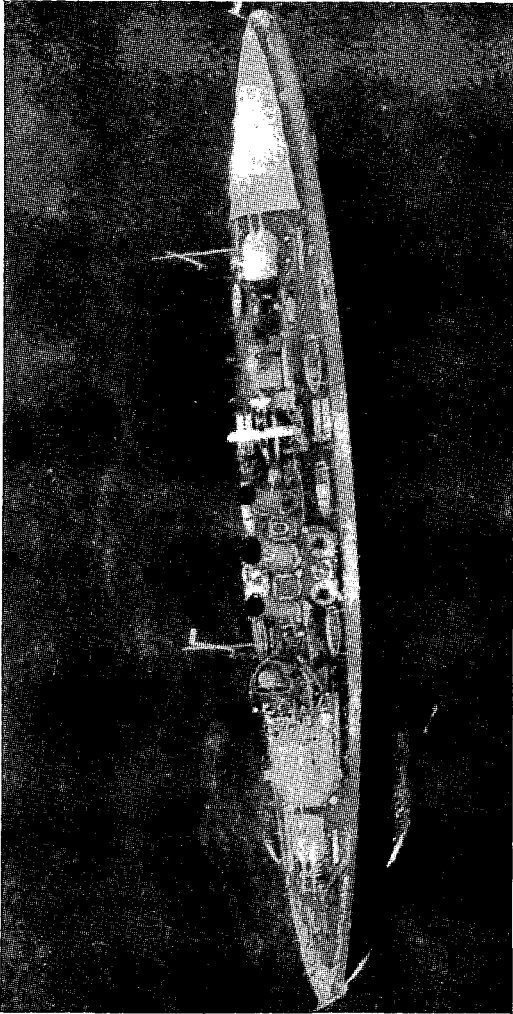

Cruiser NORFOLK.

BRITISH NAVY

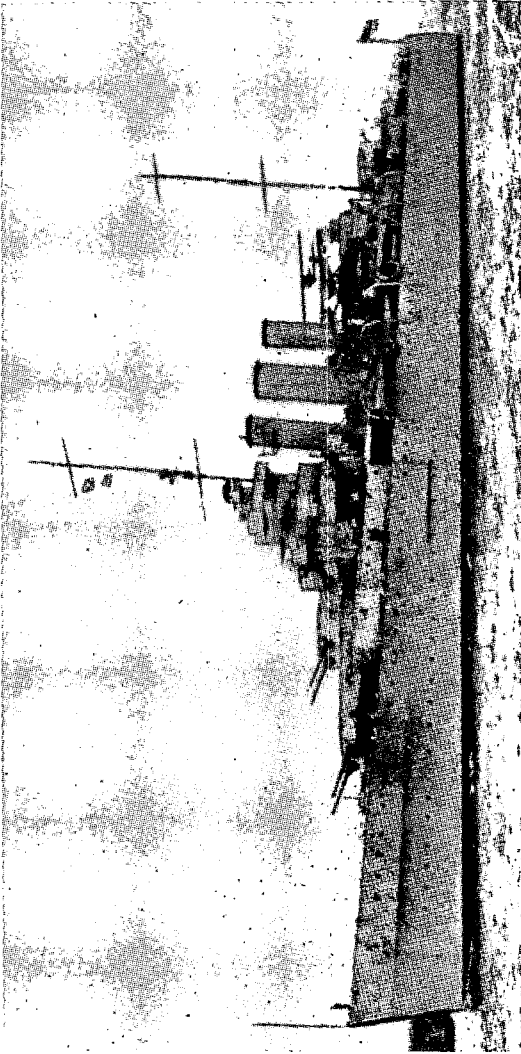

Cruiser SHROPSHIRE.

IDENTIFICATION OF BRITISH NAVAL SHIPS

Cruisers
London Class
(4 ships)

DEVONSHIRE
LONDON
SHROPSHIRE
SUSSEX

Description: Displacement: 9,850 tons.
Length: 633 feet (over-all).
Beam: 66 feet.
Draft: 17 feet (mean).
Speed: 32 knots.

Guns: 8—8-inch.
8—4-inch AA.
4—3-pounder.
14 smaller.

Torpedo tubes: 8—21-inch (quadrupled).

Aircraft: 1. Catapults: 1.

BRITISH NAVY

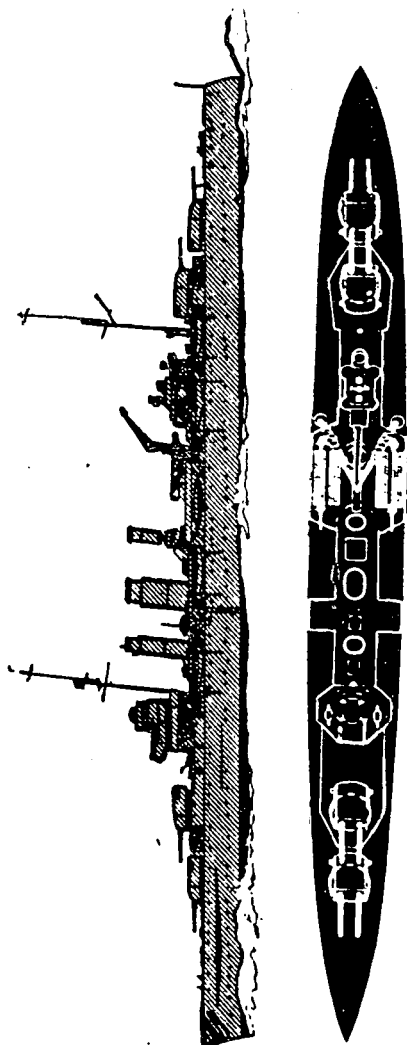

Cruiser, London Class.

Cruisers
London Class

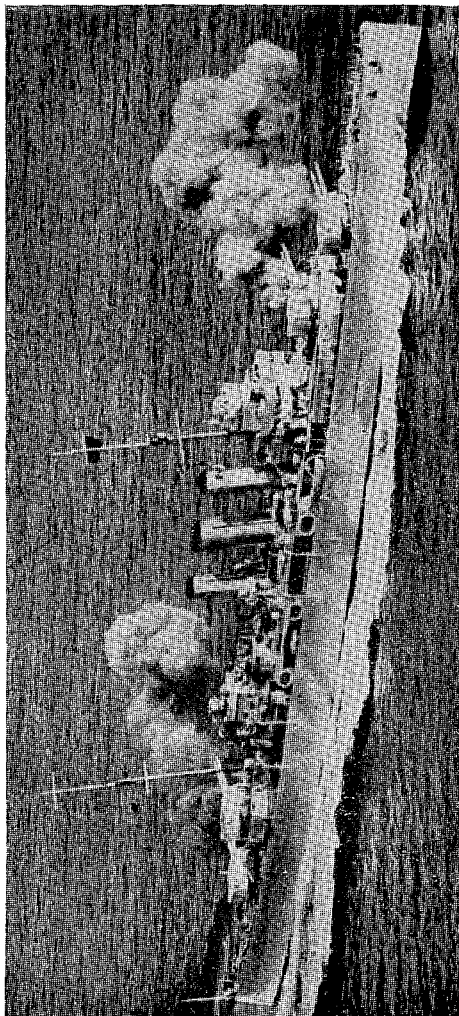

Cruiser DEVONSHIRE.

BRITISH NAVY

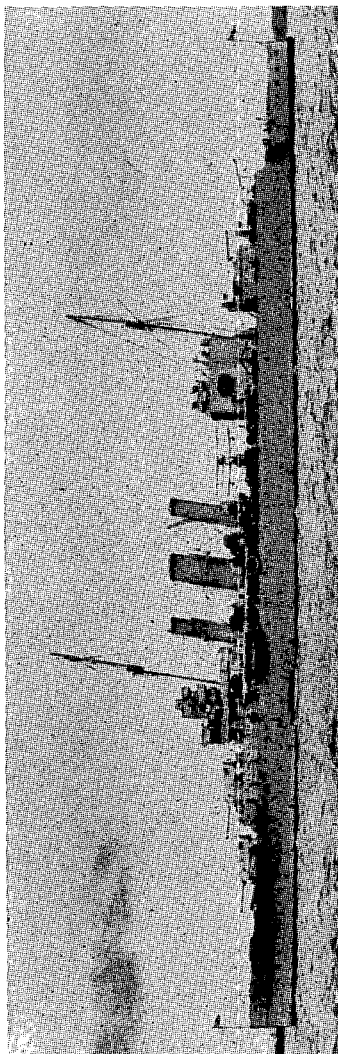

Cruiser CUMBERLAND.

IDENTIFICATION OF BRITISH NAVAL SHIPS

Cruisers
Kent Class
(5 ships)

BERWICK
CORNWALL
CUMBERLAND
KENT
SUFFOLK

Description: Displacement: 10,000 tons.
Length: 630 feet (over-all).
Beam: 68½ feet.
Draft: 16¼ feet (mean).
Speed: 31.5 knots.

Guns: 8—8-inch.
8—4-inch AA (6 in SUFFOLK).
20 smaller.

Torpedo tubes: (Removed).

Aircraft: 3. Catapults: 1.

BRITISH NAVY

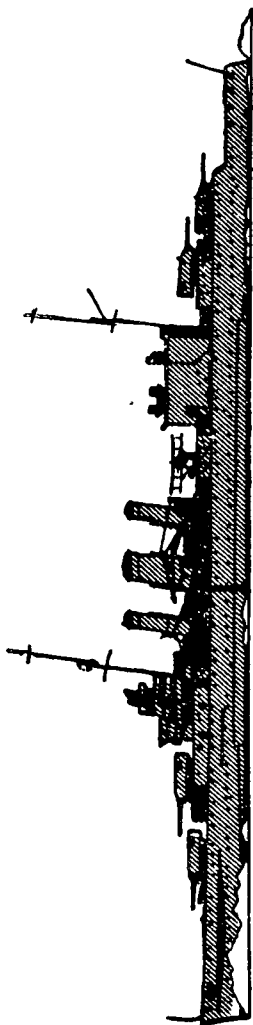

CUMBERLAND, also SUFFOLK.

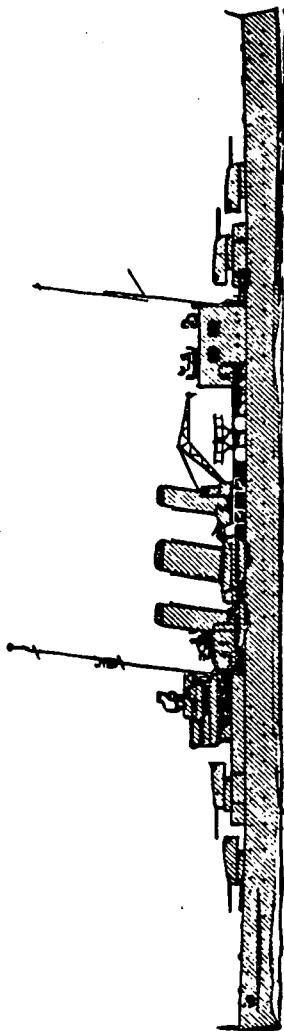

BERWICK and CORNWALL.
Cruisers of Kent Class.

Cruisers
Kent Class

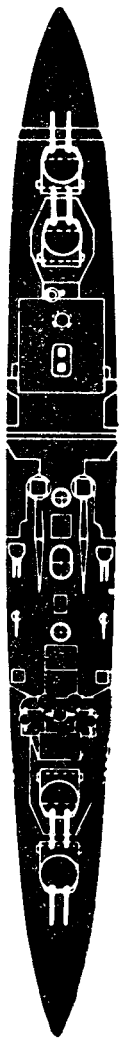
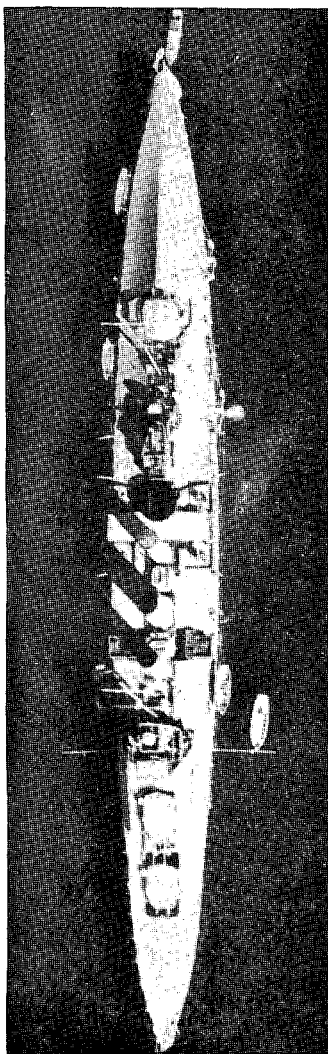

Cruiser KENT.

BRITISH NAVY

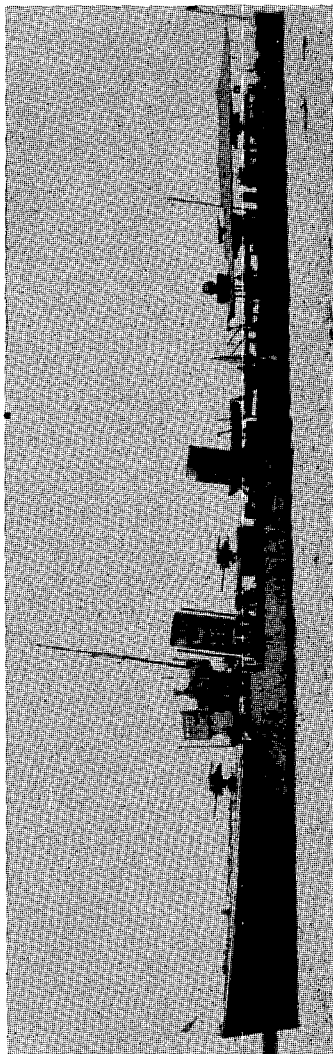

Cruiser TRINIDAD.

IDENTIFICATION OF BRITISH NAVAL SHIPS

Cruisers
Fiji Class
(13 ships)

FIJI

KENYA

MAURITIUS

NIGERIA

UGANDA (to be completed in 1942)

TRINIDAD

CEYLON (to be completed in 1942)

GAMBIA (to be completed in 1942)

JAMAICA (to be completed in 1942)

4 more (names not released)

Description: Displacement: 8,000 tons.

Length: 549 feet.

Beam: 62 feet.

Draft: 16½ feet.

Speed: 33 knots.

Guns: 12—6-inch.

8—4-inch AA.

16 smaller.

Aircraft: 3. Catapults: 1.

BRITISH NAVY



Silhouette Fiji Class.

IDENTIFICATION OF BRITISH NAVAL SHIPS

**Cruisers
Fiji Class
(13 ships)**

BRITISH NAVY

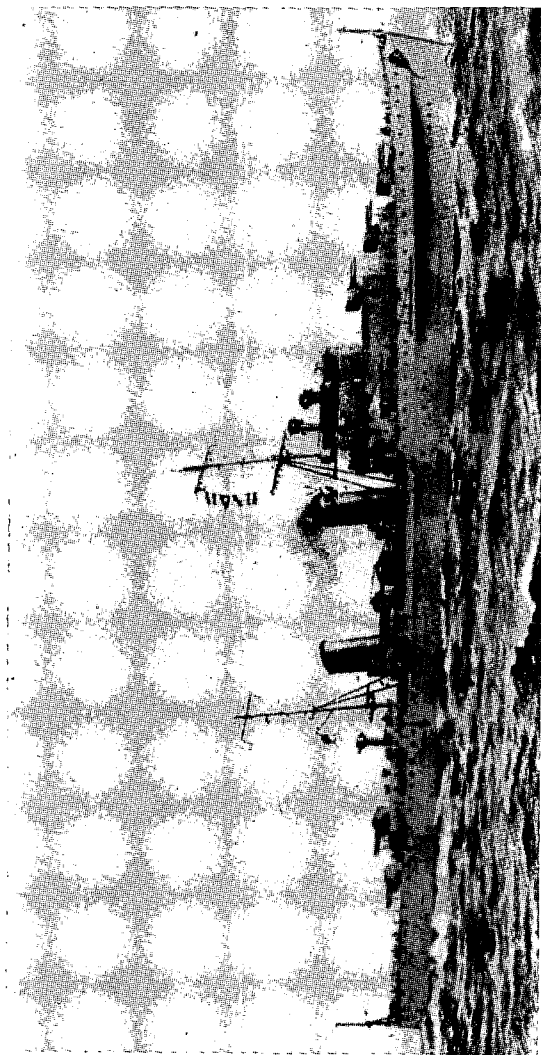

Cruiser DIDO.

Cruisers
Dido Class
(10 ships)

DIDO
EURYALUS
NAIAD
PHOEBE
SIRIUS
BONAVENTURE
HERMIONE
CHARYBDIS
CLEOPATRA
SCYLLA

Description: Displacement: 5,450 tons.

Length: 506 feet.

Beam: 51½ feet.

Draft: 14 feet.

Speed: 33 knots.

Guns: 10—5.25-inch.

8—4-inch AA.

16 smaller.

Torpedo tubes: 6—21-inch (tripled).

Aircraft: 1. Catapults: 1.

BRITISH NAVY

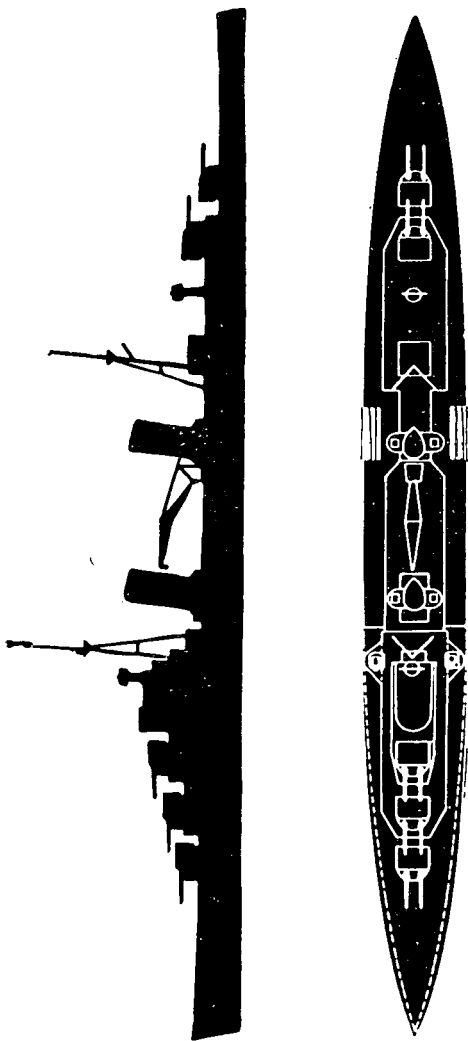

Cruisers, Dido Class.

IDENTIFICATION OF BRITISH NAVAL SHIPS

**Cruisers
Dido Class
(10 ships)**

BRITISH NAVY

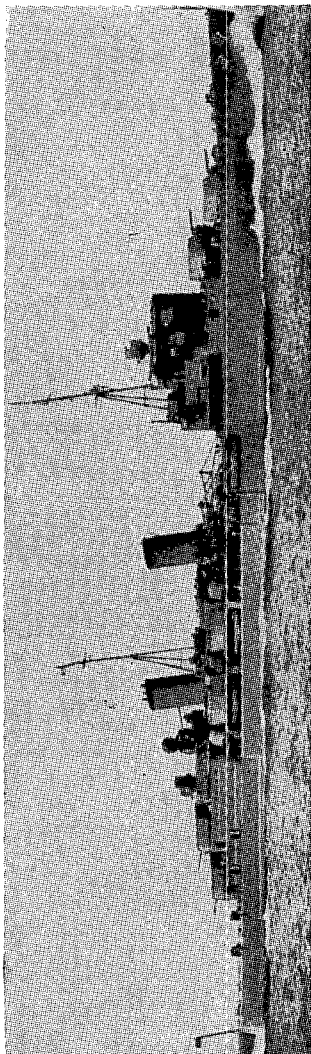

Cruiser BELFAST.

Cruisers
Edinburgh Class

EDINBURGH
BELFAST

Description: Displacement: 10,000 tons.
Length: 613½ feet (over-all).
Beam: 63 feet.
Draft: 17¼ feet.
Speed: 32.5 knots.

Guns. 12—6-inch.
12—4-inch AA.
4—3-pounder.
16 smaller.

Torpedo tubes: 6—21-inch (tripled).
Aircraft: 4. Catapults: 1.

BRITISH NAVY

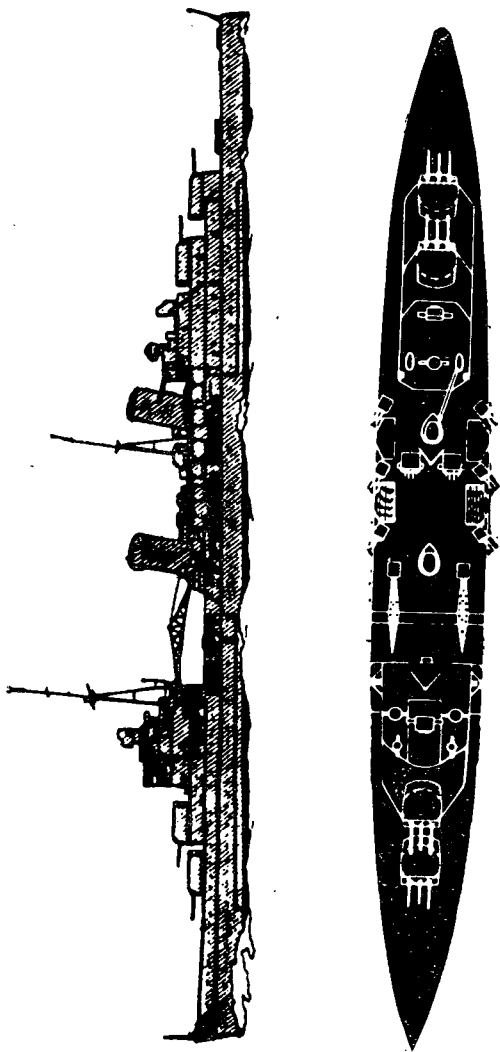

Cruisers, Edinburgh Class.

IDENTIFICATION OF BRITISH NAVAL SHIPS

**Cruisers
Edinburgh Class**

BRITISH NAVY



Cruiser SOUTHAMPTON.

IDENTIFICATION OF BRITISH NAVAL SHIPS

Cruisers
Southampton Class
(8 ships)

SOUTHAMPTON (lost January 10, 1941)

NEWCASTLE

SHEFFIELD

BIRMINGHAM

GLASGOW

GLOUCESTER

LIVERPOOL

MANCHESTER

Description: Displacement: 9,100 tons.

Length: 591½ feet (over-all).

Beam: 61⅔ feet.

Draft: 17 feet (mean).

Speed: 32 knots.

Guns: 12—6-inch.

8—4-inch AA.

1—3.7-inch howitzer.

4—3-pounder.

16 smaller.

Torpedo tubes: 6—21-inch (tripled).

Aircraft: 3. Catapults: 1.

BRITISH NAVY

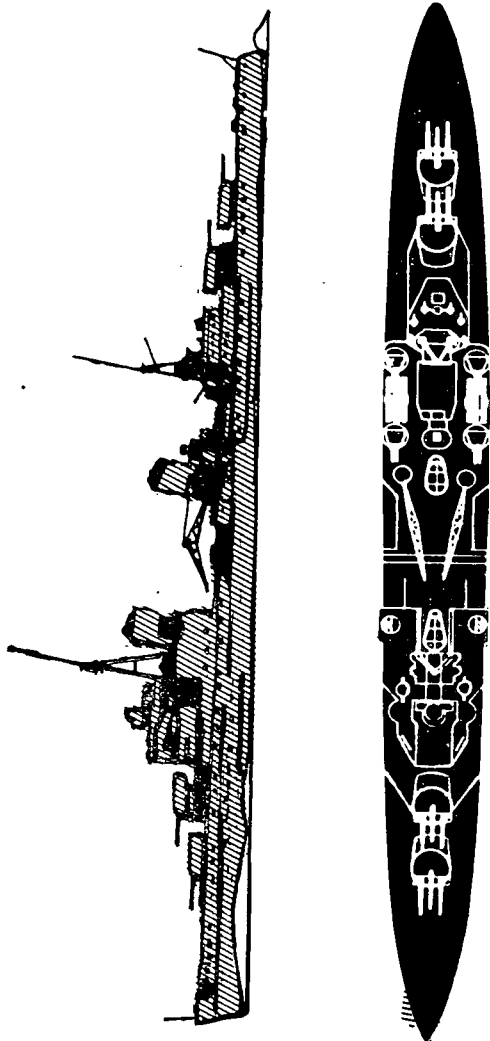

Cruisers, Southampton Class.

IDENTIFICATION OF BRITISH NAVAL SHIPS

Cruisers
Southampton Class
(8 ships)

BRITISH NAVY

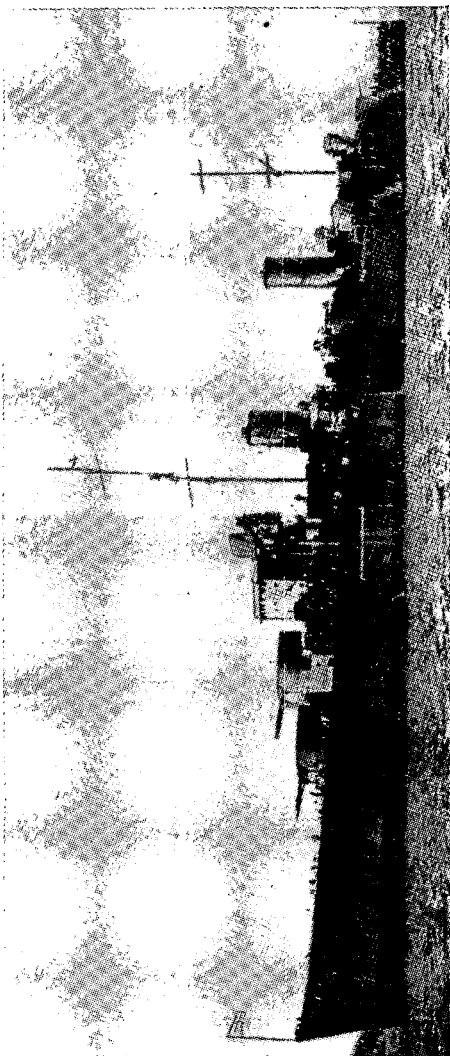

Cruiser AURORA.

IDENTIFICATION OF BRITISH NAVAL SHIPS

Cruisers
Arethusa Class
(4 ships)

ARETHUSA
GALATEA
PENELOPE
AURORA

Description: Displacement: 5,270 tons.
Length: 500 feet (waterline).
Beam: 51 feet.
Draft: 13 feet 10 inches (mean).
Speed: 32.25 knots.

Guns: 6—6-inch.
8—4-inch AA.
2—3-pounder.
7 smaller.

Torpedo tubes: 6—21-inch (tripled).

Aircraft: 1 (not carried at present by AURORA).

Catapults: 1 (AURORA none).

BRITISH NAVY

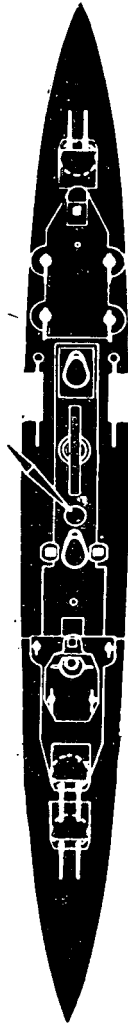
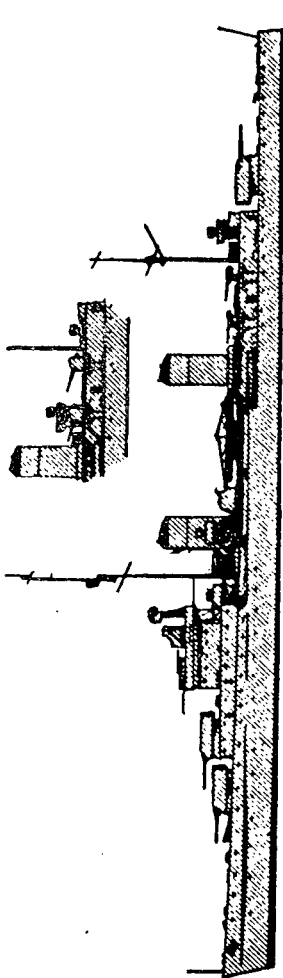

Cruisers, Arethusa Class.

(AURORA as part sketch, with hangar between funnels.) (AA guns now are paired.)

IDENTIFICATION OF BRITISH NAVAL SHIPS

Cruisers
Arethusa Class
(4 ships)

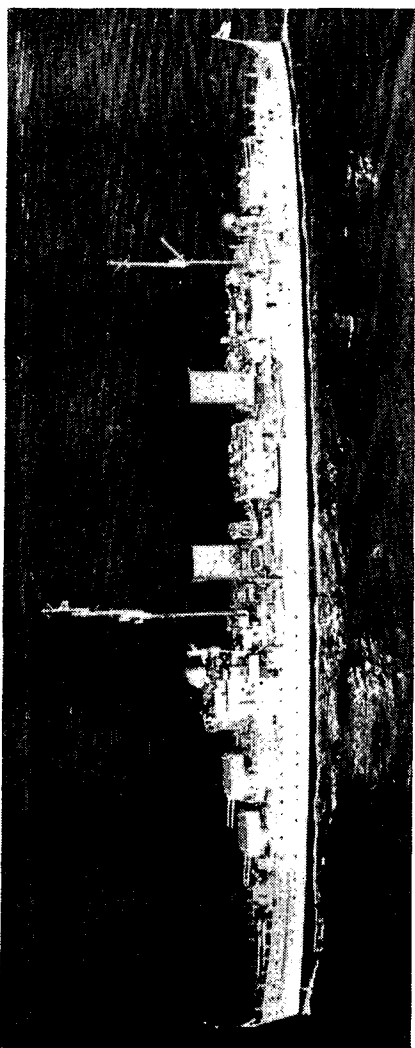

Cruiser AURORA.

BRITISH NAVY

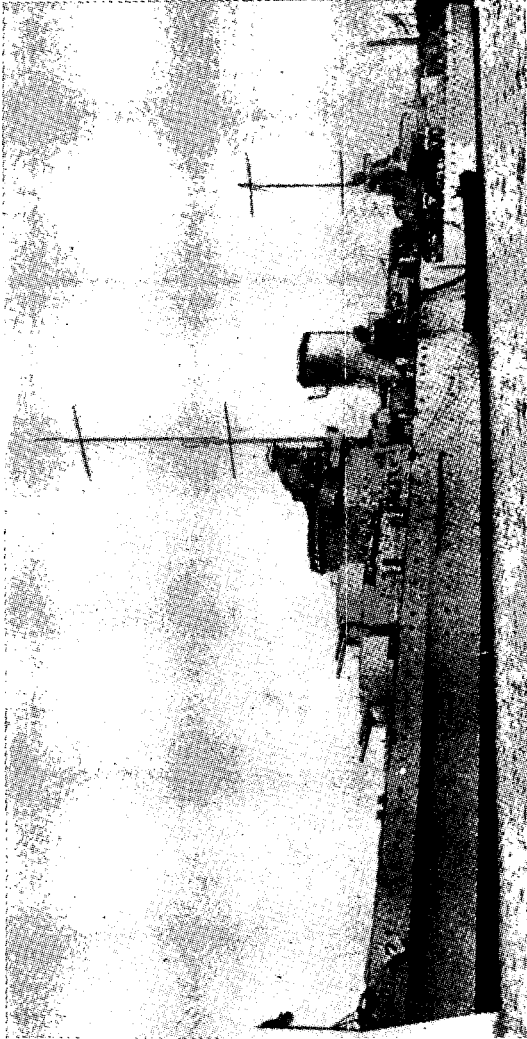

Cruiser ORION.

IDENTIFICATION OF BRITISH NAVAL SHIPS

Cruisers
Leander Class
(5 ships)

LEANDER (7,270 tons)
ORION (7,215 tons)
NEPTUNE (7,175 tons)
ACHILLES (7,030 tons)
AJAX (6,985 tons)

Description: Displacement: As above.
Length: 554½ feet (over-all).
Beam: 55 feet.
Draft: 16 feet (mean) (AJAX, 15½).
Speed: 32.5 knots.

Guns: 8—6-inch.
8—4-inch AA (4 in ACHILLES).
4—3-pounder.
10 smaller.

Torpedo tubes: 8—21-inch (quadrupled).

Aircraft: Catapult: 1.

LEANDER, ACHILLES, 1 each.

ORION, NEPTUNE, AJAX, 2 each.

Note: ACHILLES and LEANDER lent to Dominion of New Zealand.

BRITISH NAVY

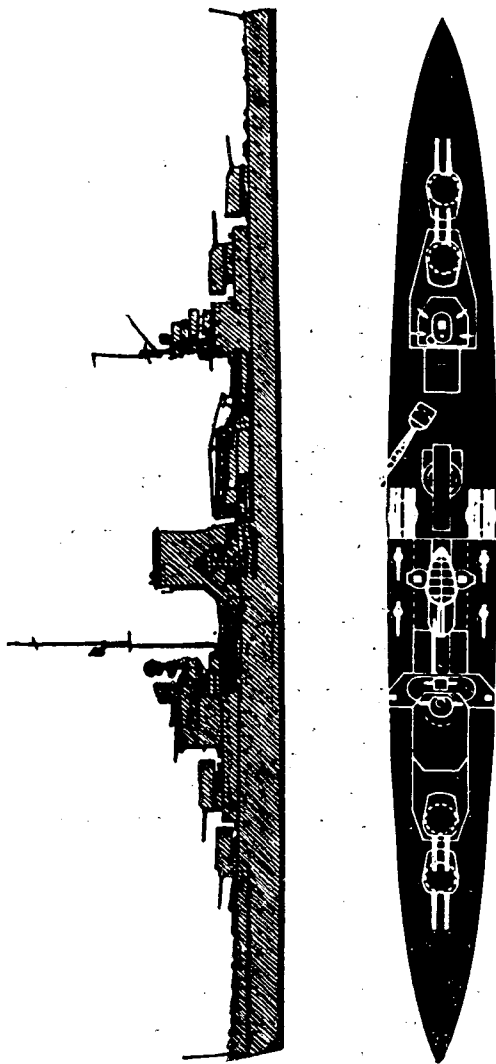

Cruisers, Leander Class.

(NEPTUNE has shorter foremast and AJAX has hers stepped slightly farther aft. Crane is actually mounted on centerline and AA guns are paired.)

IDENTIFICATION OF BRITISH NAVAL SHIPS

Cruisers
Leander Class
(5 ships)

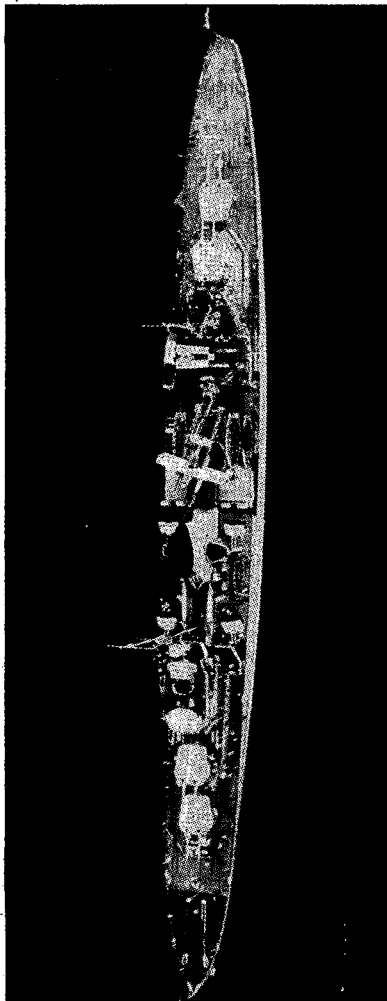

Cruiser ORION.

BRITISH NAVY



Cruiser EMERALD.

IDENTIFICATION OF BRITISH NAVAL SHIPS

Cruisers
EMERALD, ENTERPRISE

EMERALD (7,550 tons)

ENTERPRISE (7,580 tons)

Description: Displacement: As above.

Length: 570 feet (over-all).

Beam: 54½ feet.

Draft: 16½ feet (mean).

Speed: 33 knots (full load, 32).

Guns: 7—6-inch.

5—4-inch AA.

4—3-pounder.

9 smaller.

Torpedo tubes: 16—21-inch (quadrupled).

Aircraft: 1. Catapult: 1.

BRITISH NAVY

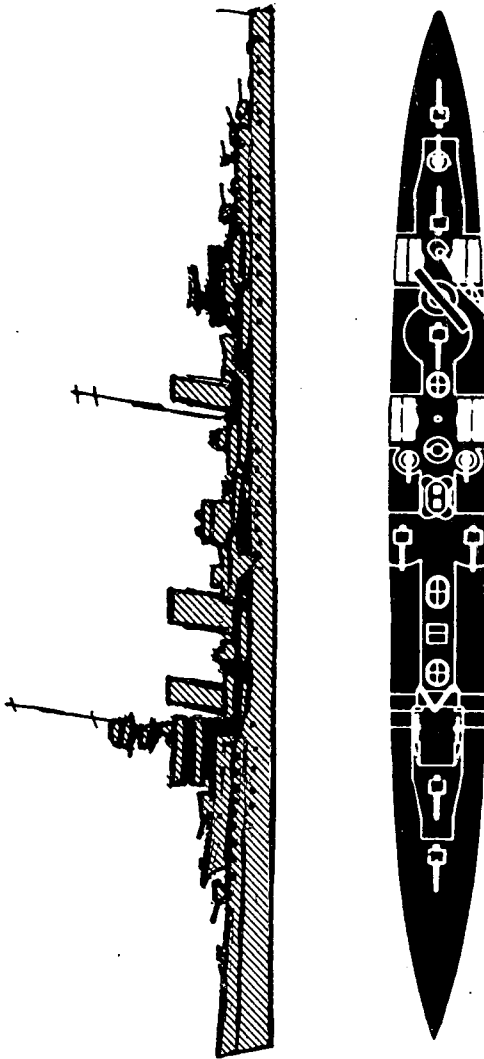

Cruisers EMERALD and ENTERPRISE.
(4-inch AA guns amidships should be shown in pairs.)

IDENTIFICATION OF BRITISH NAVAL SHIPS

**Cruisers
EMERALD, ENTERPRISE**

BRITISH NAVY

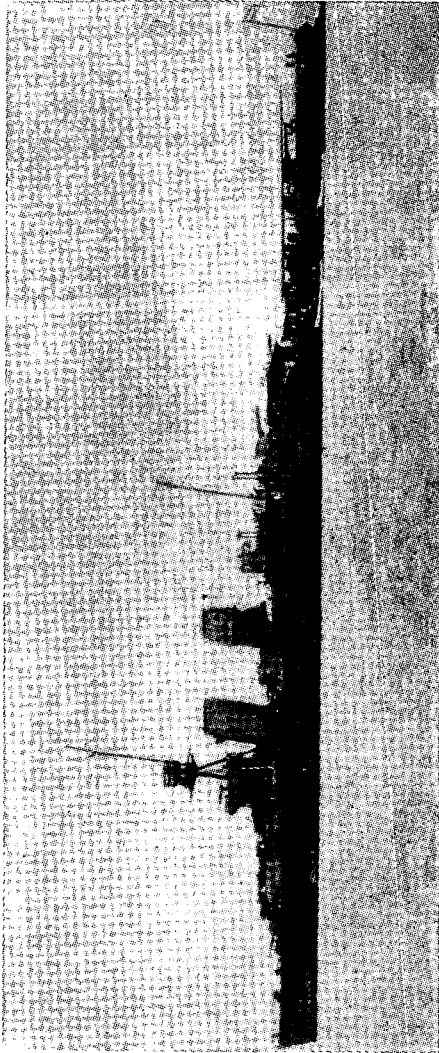

Cruiser HAWKINS.

IDENTIFICATION OF BRITISH NAVAL SHIPS

Cruisers
Hawkins Class

FROBISHER (9,860 tons)

HAWKINS (9,800 tons)

Description: Displacement: As above.

Length: 605 feet (over-all).

Beam: 65 feet (outside bulges).

Draft: 20½ feet (maximum).

Speed: 30.5 knots, FROBISHER.

29.5 knots, HAWKINS.

Guns: (Originally) 7—7.5-inch.

4—4-inch AA.

14 smaller.

Torpedo tubes: 4—21-inch (above water).

Aircraft: To be added to equipment.

BRITISH NAVY

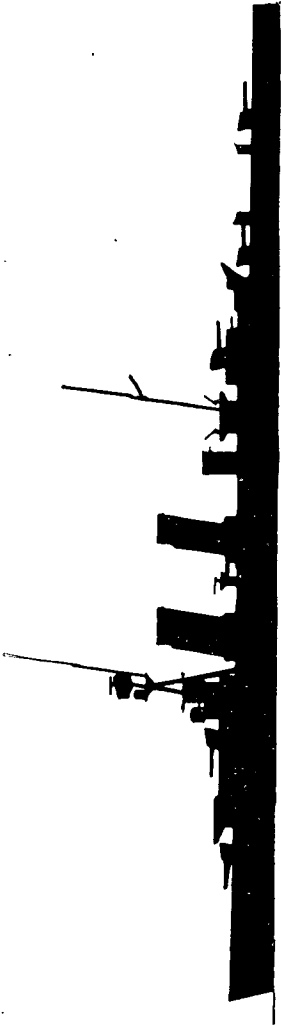

Cruisers, Hawkins Class.

IDENTIFICATION OF BRITISH NAVAL SHIPS

**Cruisers
Hawkins Class**

BRITISH NAVY

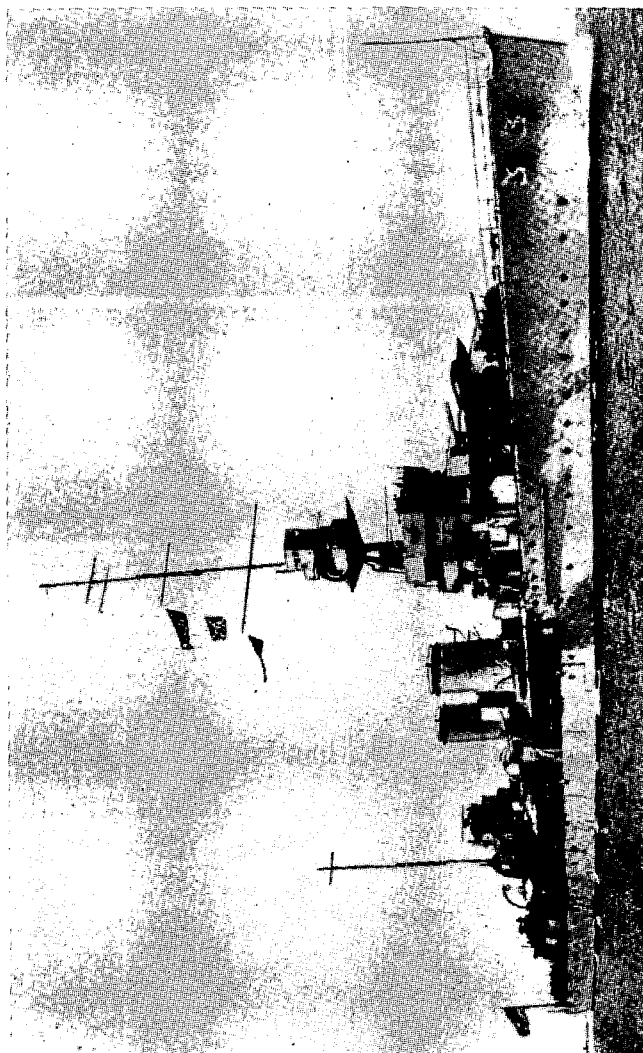

Cruiser DAUNTLESS.

IDENTIFICATION OF BRITISH NAVAL SHIPS

Cruisers
"D" Class
(8 ships)

DESPATCH
DIOMEDE
DELHI
DUNEDIN
DURBAN
DANAE
DAUNTLESS
DRAGON

Description: Displacement: 4,850 tons.
Length: 472½ feet (over-all).
Beam: 46½ feet.
Draft: 16½ feet (maximum).
Speed: 29 knots.

Guns: 6—6-inch.
3—4-inch AA.
4—3-pounder.
11 to 13 smaller.

Torpedo tubes: 12—21-inch (tripled).

BRITISH NAVY

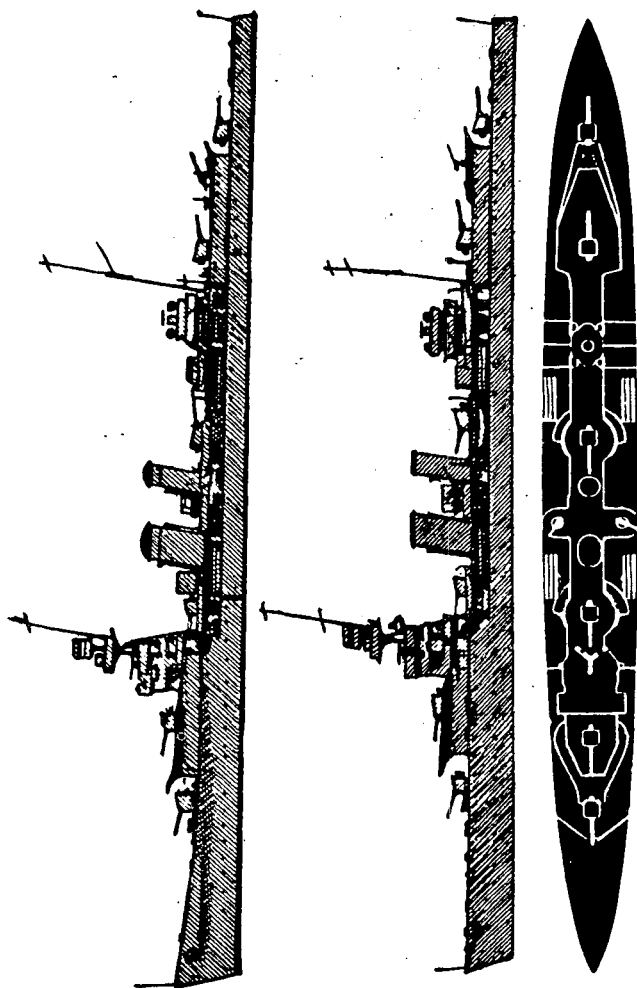

DELHI, DANAE, DAUNTLESS, DRAGON.
Cruisers of the "D" Class.

IDENTIFICATION OF BRITISH NAVAL SHIPS

Cruisers
"D" Class
(8 ships)

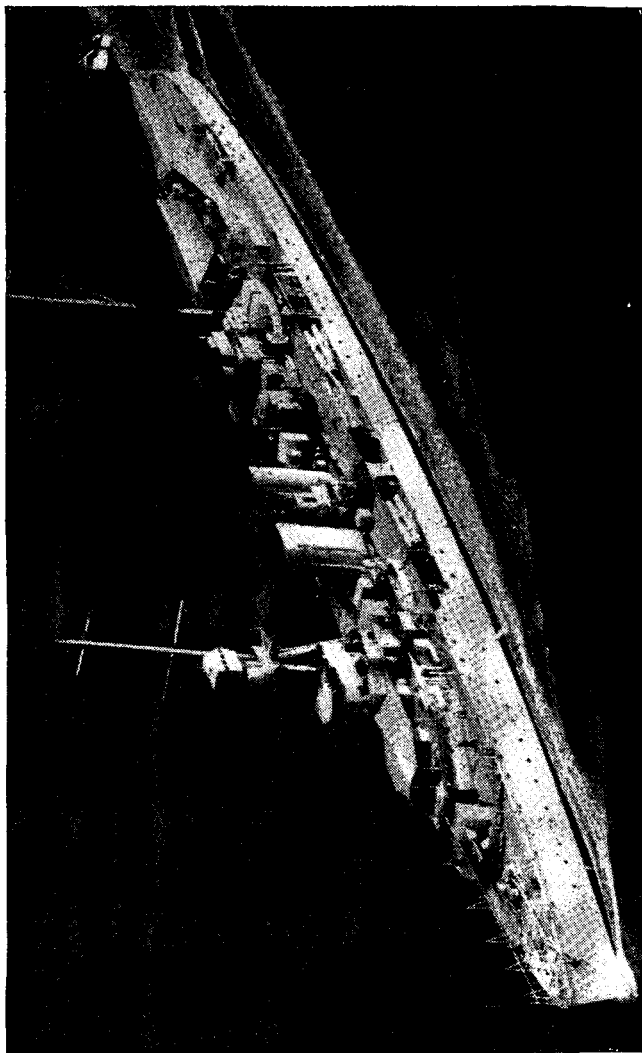

Cruiser DANAE.

BRITISH NAVY

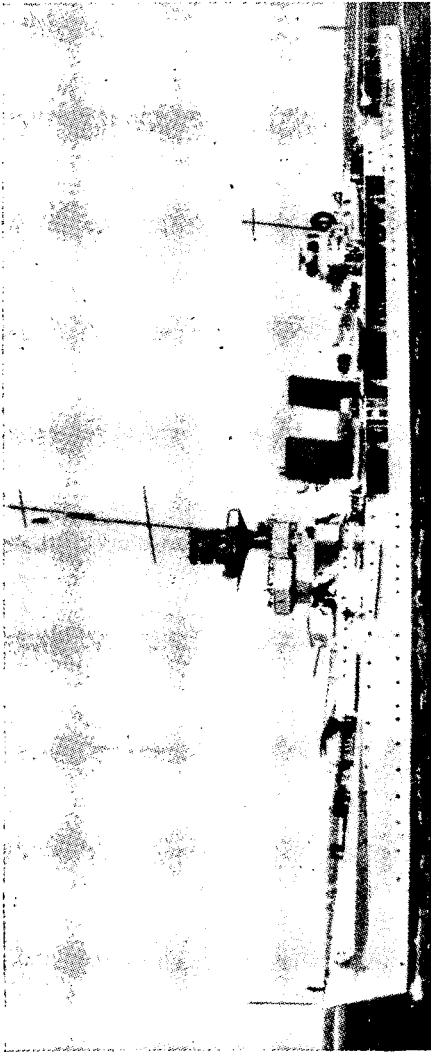

Cruiser COLONBO.

IDENTIFICATION OF BRITISH NAVAL SHIPS

Cruisers
CAPETOWN, COLOMBO,
CARDIFF, CERES

CAPETOWN
COLOMBO
CARDIFF
CERES

Description: Displacement: 4,290 tons.
Length: 450 feet (over-all).
Beam: 43½ feet.
Draft: 16¼ feet (maximum).
Speed: 29 knots.

Guns: 5—6-inch.
2—3-inch AA.
2 to 4—3-pounder.
9 to 11 smaller.

Torpedo tubes: 8—21-inch (double mountings above water).

Special note: CAPETOWN and COLOMBO were to have been re-armed as antiaircraft ships, but whether this has been done has not been announced.

BRITISH NAVY

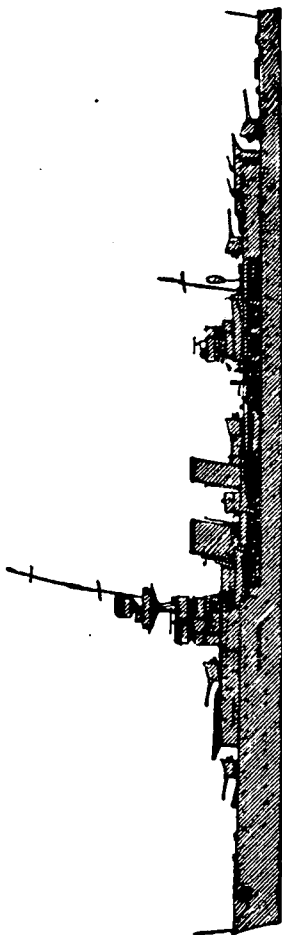

Cruiser CERES.

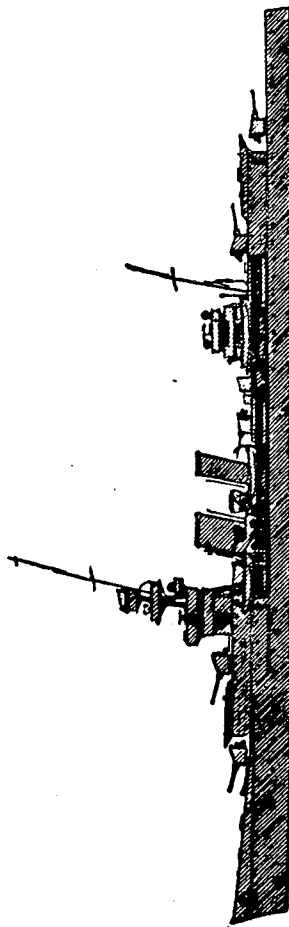

Cruisers COLOMBO, CAPE TOWN.

IDENTIFICATION OF BRITISH NAVAL SHIPS

Cruisers
CAPETOWN, COLOMBO,
CARDIFF, CERES

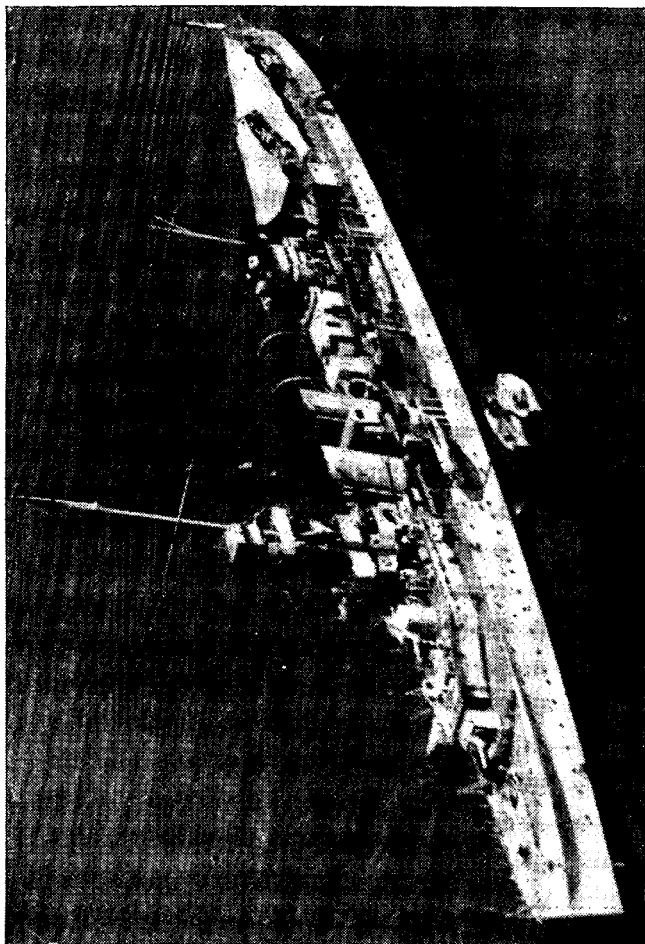

Cruiser CAPETOWN.

BRITISH NAVY

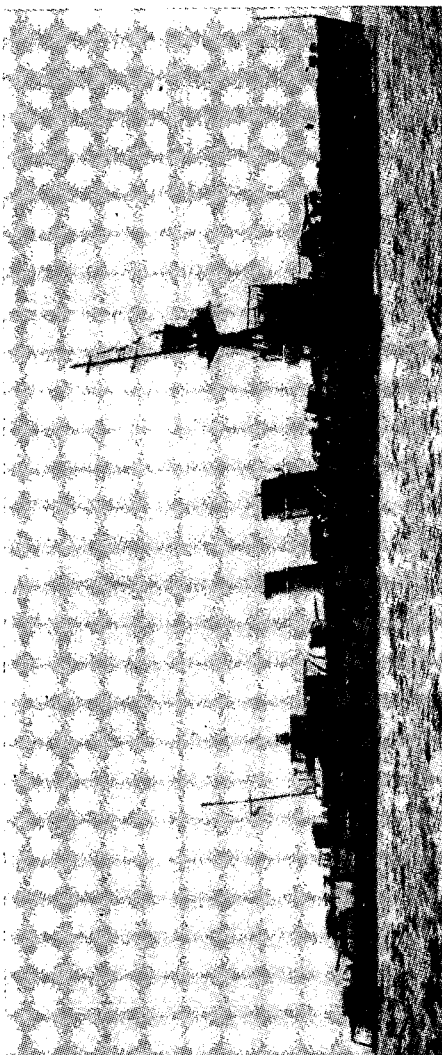

Cruiser CALEDON.

**CALEDON
CARADOC**

Description: Displacement: 4,180 tons.
Length: 450 feet (over-all).
Beam: $42\frac{3}{4}$ feet.
Draft: $16\frac{1}{4}$ feet (maximum).
Speed: 29 knots.

Guns: 5—6-in.
2—3-inch AA.
4—3-pounder.
11 smaller.

Torpedo tubes: 8—21-inch (in pairs, above water).

BRITISH NAVY

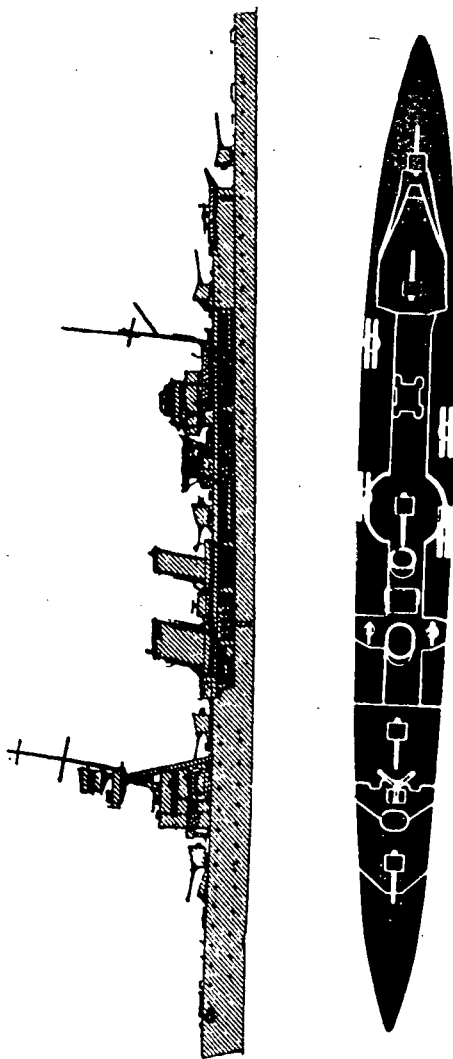

Cruisers, Caledon Class.

Cruisers
Caledon Class

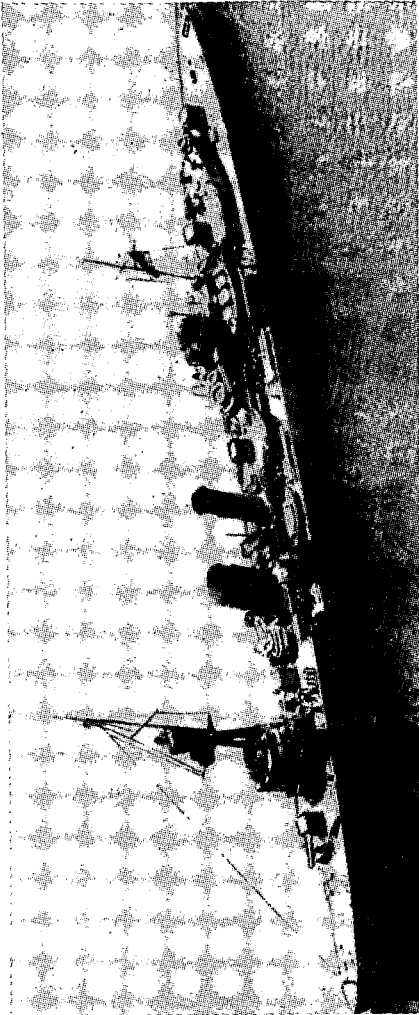

Cruiser CARADOC.

BRITISH NAVY

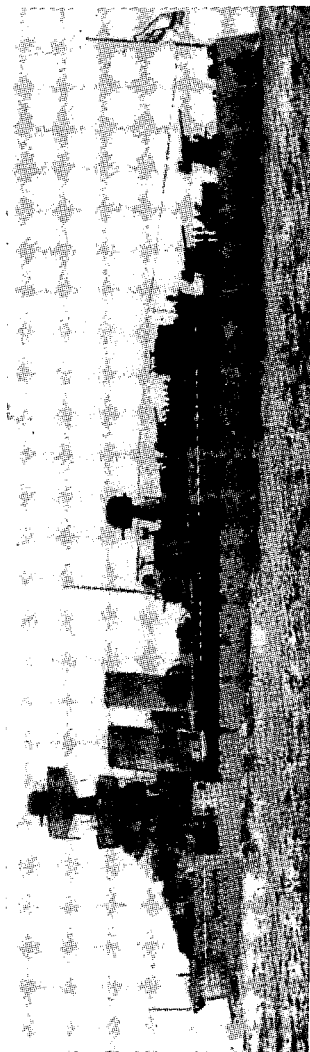

Anti-aircraft ship COVENTRY.

Antiaircraft Ship
COVENTRY

COVENTRY (ex-CORSAIR)

Description: Displacement: 4,290 tons.
Length: 450 feet (over-all).
Beam: 43½ feet.
Draft: 16¼ feet (maximum).
Speed: 29 knots.

Guns: 10—4-inch AA.
1 multiple pompom.
10 smaller.

BRITISH NAVY

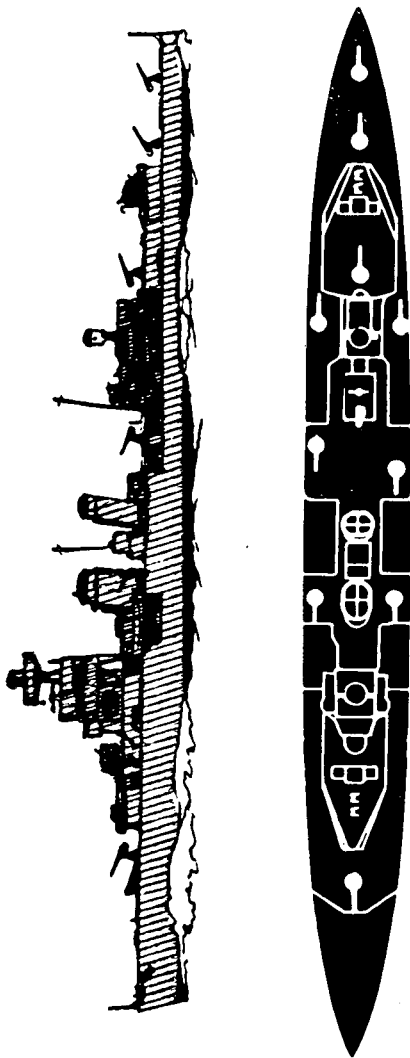

Anti-aircraft ship COVENTRY.

IDENTIFICATION OF BRITISH NAVAL SHIPS

**Antiaircraft Ship
COVENTRY**

BRITISH NAVY

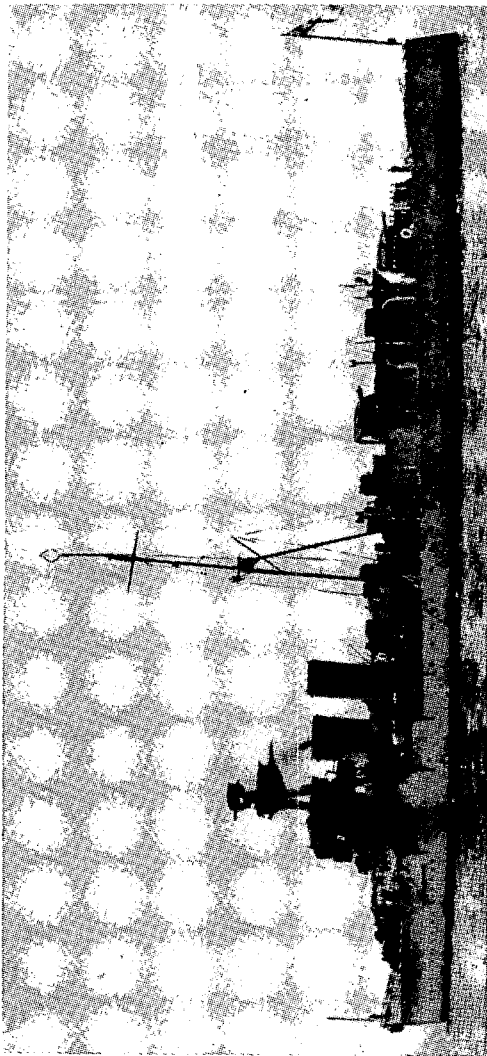

Anti-aircraft ship CAIRO.

IDENTIFICATION OF BRITISH NAVAL SHIPS

Antiaircraft Ships
Cairo Class

CAIRO
CALCUTTA
CARLISLE
CURACOA

Description: Displacement: 4,200 tons.
Length: 450 feet (over-all).
Beam: 43½ feet.
Draft: 16¼ feet (maximum).
Speed: 29 knots.

Guns: 8—4-inch AA.
1 multiple pompom.
Several smaller.

BRITISH NAVY

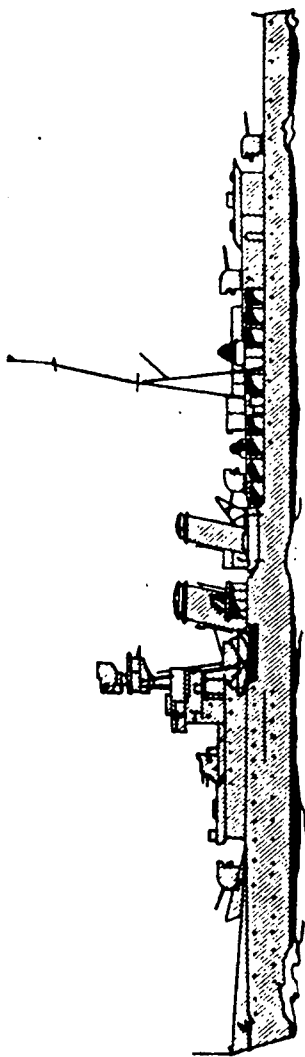

Anti-aircraft ships, Cairo Class.
(CURAÇOA, without trawler bow.)

IDENTIFICATION OF BRITISH NAVAL SHIPS

Antiaircraft Ships
Cairo Class

BRITISH NAVY

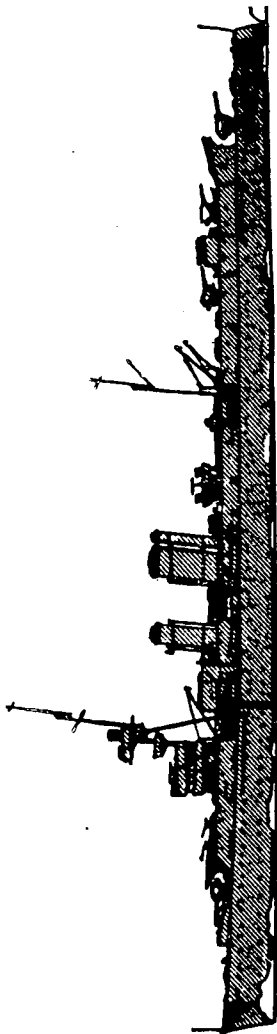
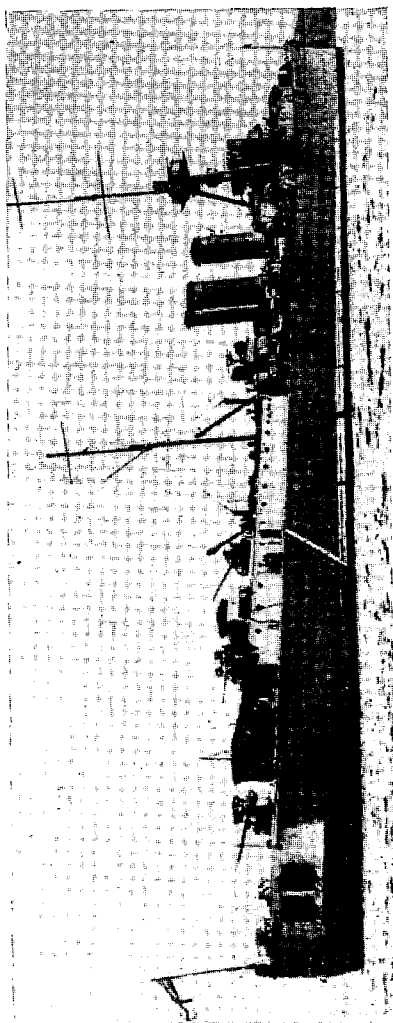

Cruiser-mine layer ADVENTURE.

IDENTIFICATION OF BRITISH NAVAL SHIPS

Mine layers
"Cruiser-Mine layer" Type

ADVENTURE

Description: Displacement: 6,740 tons.
Length: 520 feet (over-all).
Beam 59 feet (over bulges).
Draft: 19¼ feet (mean).
Speed: 28 knots.

Guns: 4—4.7-inch AA.
4—3-pounder.
18 smaller.

Number of mines carried: 340.



Note: Stern is now rounded as shown in illustration on page 126.

MILITARY INTELLIGENCE

BRITISH NAVY

IDENTIFICATION OF BRITISH NAVAL SHIPS

Mine layers
Latonia Class
(4 ships)

ABDIEL
LATONIA
MANXMAN
WELSHMAN

Description: Displacement: 2,650 tons.

Length: 410 feet.

Beam:

Draft:

Speed: 40 knots.

Guns: 6—4.7-inch.

Several smaller.

Note: Completed 1940-41; no photographs available.

MILITARY INTELLIGENCE

BRITISH NAVY

IDENTIFICATION OF BRITISH NAVAL SHIPS

Destroyers
Lightning Class

LAFOREY (1,935 tons)	MILNE (1,935 tons)
LANCE	MARKSMAN
LARNE	MUSKETEER
LIVELY	MYRMIDON
LEGION	MATCHLESS
LIGHTNING	METEOR
LOOKOUT	MARNE
LOYAL	MARTIN

Description: Displacement: 1,920 tons, except as noted above.

Length: 354 feet.

Beam: 37 feet.

Draft: 10 feet.

Speed: 36.5 knots.

Guns: 6—4.7-inch AA.

Several smaller.

Torpedo tubes: 8—21-inch.

Note: Destroyers, Lightning Class said to be of modified Javelin Class design. Recent construction; no photographs available.

BRITISH NAVY

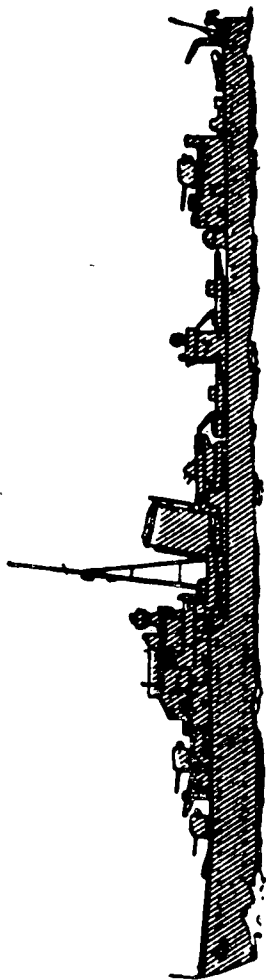
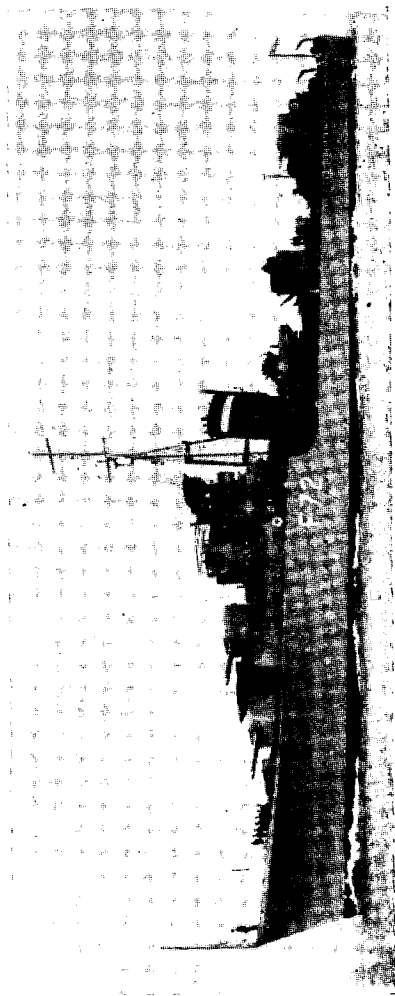

Javelin Class.

Destroyer JERSEY.

IDENTIFICATION OF BRITISH NAVAL SHIPS

Destroyers
Javelin Class
(24 ships)

JERVIS	NOBLE	KASHMIR
KELLY	NONPAREIL	KIMBERLEY
JACKAL	NAPIER	NORMAN
JAVELIN	JUNO	NORSEMAN
NERISSA	KELVIN	JUPITER
NIZAM	NESTOR	KIPLING
JAGUAR	JANUS	JERSEY
KANDAHAR	KHARTOUM	KINGSTON

Description: Displacement: 1,690 tons.

Length: 348 feet.

Beam: 35 feet.

Draft: 9 feet.

Speed: 36 knots.

Guns: 6—4.7-inch.

6 smaller.

Torpedo tubes: 10—21-inch.



Destroyer, Javelin Class.

BRITISH NAVY

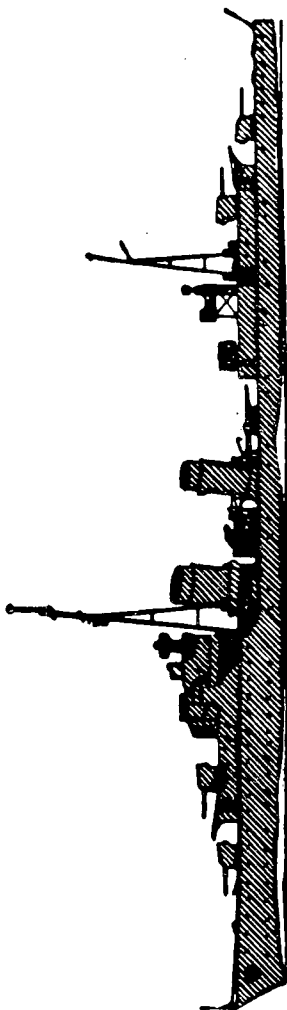
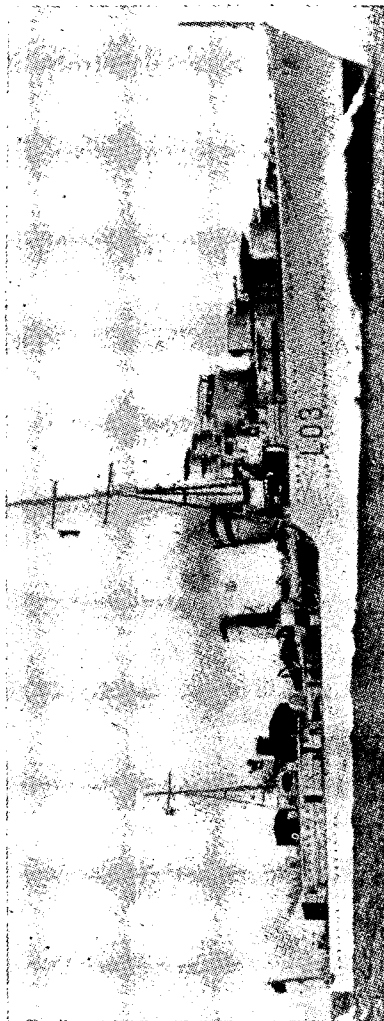

Destroyer COSSACK.

Tribal Class.

IDENTIFICATION OF BRITISH NAVAL SHIPS

Destroyers
Tribal Class
(14 ships)

COSSACK	NUBIAN	ASHANTI
ESKIMO	SIKH	BEDOUIN
MASHONA	ZULU	SOMALI
MAORI	MATABELE	TARTAR
MOHAWK	PUNJABI	

Description: Displacement: 1,870 tons.

Length: 355½ feet.

Beam: 36½ feet.

Draft: 9 feet.

Speed: 36.5 knots.

Guns: 8—4.7-inch.

7 smaller.

Torpedo tubes: 4—21-inch.



BRITISH NAVY

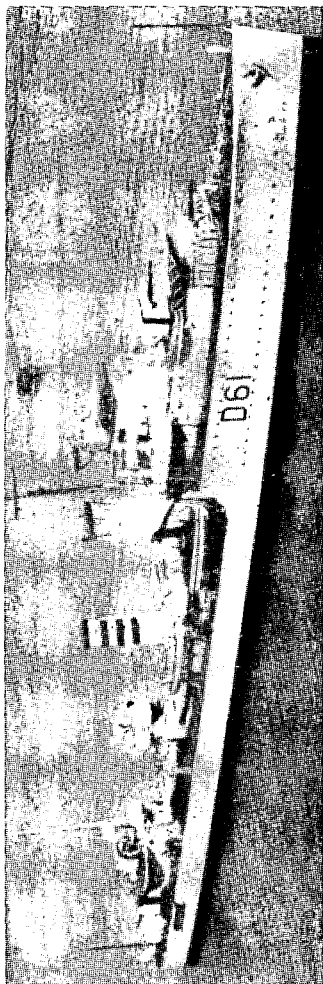

Destroyer ILEX.

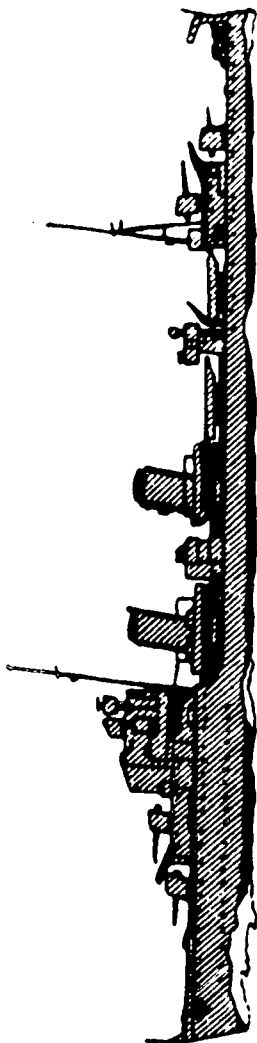

Intrepid Class.

IDENTIFICATION OF BRITISH NAVAL SHIPS

Destroyers
Intrepid Class

ICARUS
ILEX

IMPERIAL
IMPULSIVE

INTREPID
ISIS

Description: Displacement: 1,370 tons.
Length: 320 feet (waterline).
Beam: 33 feet.
Draft: 8½ feet.
Speed: 36 knots.

Guns: 4—4.7-inch.
6 smaller.

Torpedo tubes: 10—21-inch.



Destroyer, Intrepid Class.

BRITISH NAVY

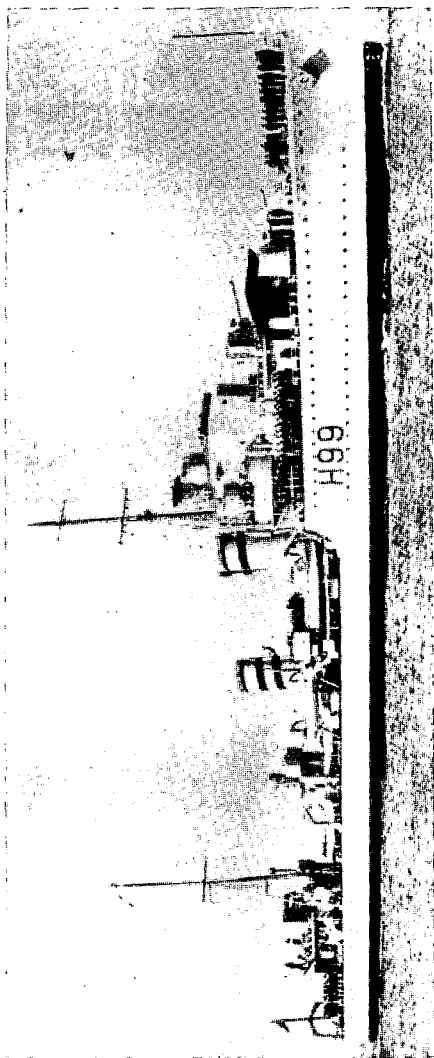

Destroyer HERO.

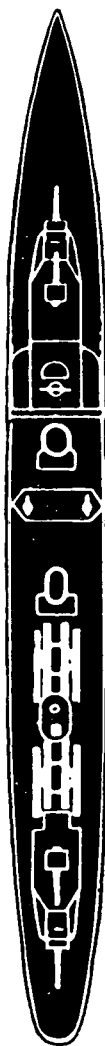

Hero and Greyhound Classes.

IDENTIFICATION OF BRITISH NAVAL SHIPS

Destroyers
Hero and Greyhound
Classes
(14 ships)

GALLANT	GRIFFIN	HEREWARD
GARLAND	HASTY	HERO
GREYHOUND	HAVOCK	HOTSPUR

(Five others acquired from Brazil; names not advised.)

Description: Displacement: 1,340 tons.

Length: 323 feet (over-all).

Beam: 33 feet.

Draft: 8½ feet (mean).

Speed: 36 knots.

Guns: 4—4.7-inch.

6 smaller.

Torpedo tubes: 8—21-inch.

BRITISH NAVY

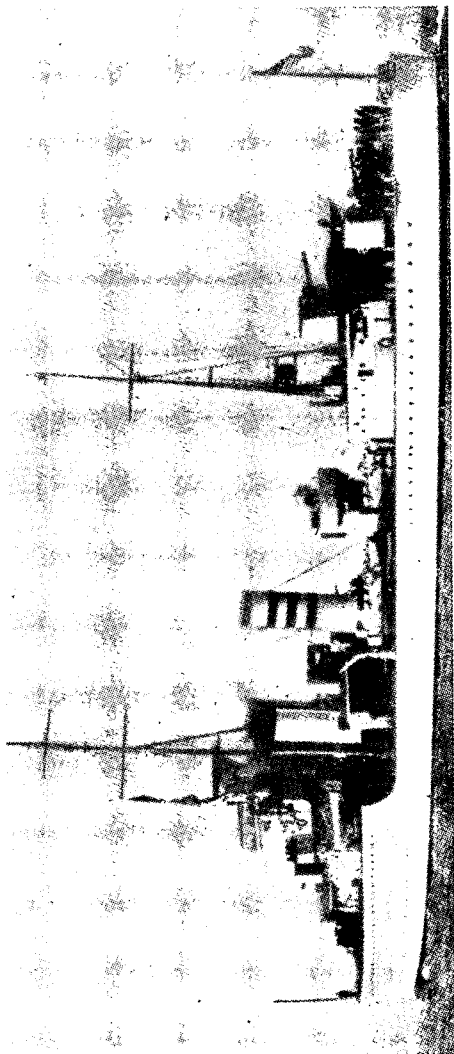

Destroyer INGLEFIELD.

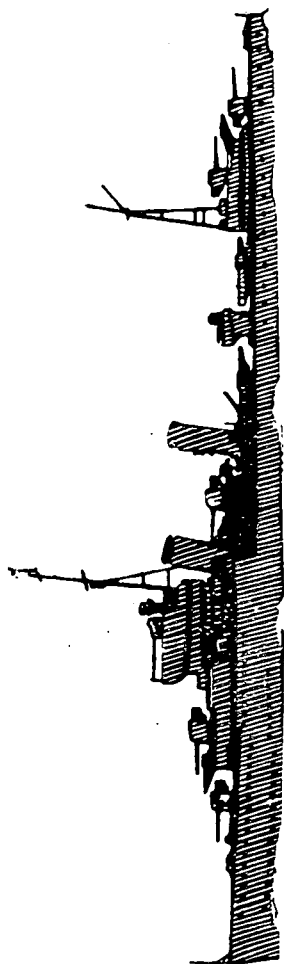

Admiralty Type Leader.

IDENTIFICATION OF BRITISH NAVAL SHIPS

Destroyers
Admiralty Type Leader
INGLEFIELD

INGLEFIELD

Description: Displacement: 1,530 tons.
Length: 334 feet (waterline).
Beam: 34 feet.
Draft: 9 feet (mean).
Speed: 36.5 knots.
Guns: 5—4.7-inch.
6 smaller.
Torpedo tubes: 10—21-inch (quintupled).



Destroyer, Admiralty Type Leader, INGLEFIELD.

BRITISH NAVY

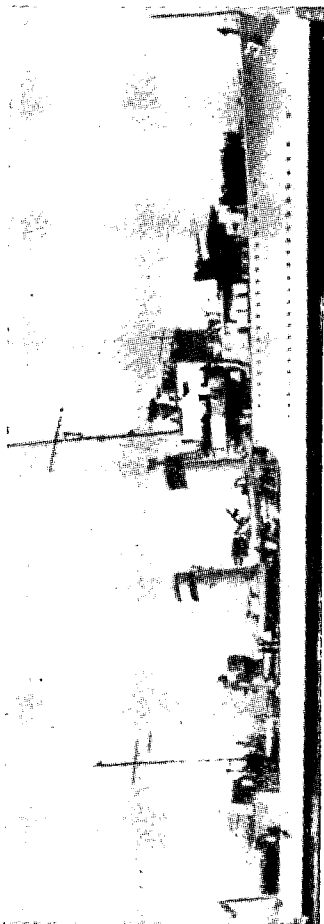

Destroyer DUNCAN.

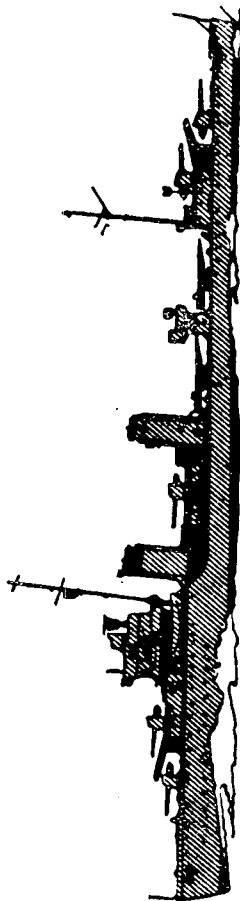

Destroyer FAULKNOR.

IDENTIFICATION OF BRITISH NAVAL SHIPS

Destroyers
Admiralty Type Leaders
DUNCAN, FAULKNOR

DUNCAN

Description: Displacement: 1,400 tons.
Length: 326 feet (waterline).
Beam: 33 feet.
Draft: $8\frac{2}{3}$ feet (mean).
Speed: 35.75 knots.

FAULKNOR

Description: Displacement: 1,460 tons.
Length: 340 feet (waterline).
Beam: $33\frac{3}{4}$ feet.
Draft: $8\frac{1}{2}$ feet (mean).
Speed: 36.75 knots.

DUNCAN AND FAULKNOR

Guns: 5—4.7-inch (DUNCAN, 4—4.7-inch).
6 smaller.
Torpedo tubes: 8—21-inch (quadrupled).



Destroyer, Admiralty Type Leaders, DUNCAN, FAULKNOR.

BRITISH NAVY

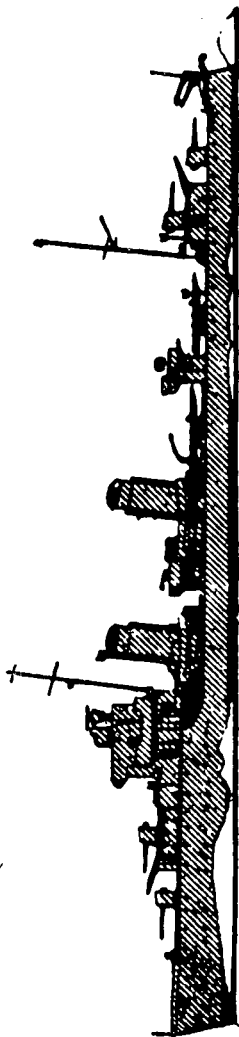
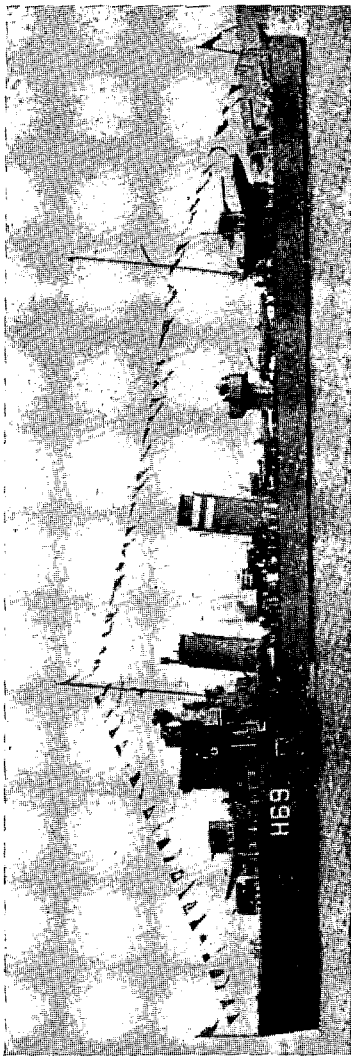

Destroyer FOXHOUND and silhouette, Eclipse and Fearless Classes (except EXPRESS).

IDENTIFICATION OF BRITISH NAVAL SHIPS

Destroyers
Eclipse and Fearless Classes
(14 ships)

ECHO	ENCOUNTER	FORESTER
ECLIPSE	FEARLESS	FURY
ESCAPADE	FORESIGHT	FAME
EXPRESS	FOXHOUND	FIREDRAKE
ELECTRA	FORTUNE	

Description: Displacement: Eclipse Class 1,375 tons.
Fearless class 1,350 tons (FEAR-
LESS 1,375).

Length: 329 feet (over-all).

Beam: 33¼ feet.

Draft: 8½ feet (mean).

Speed 36 knots.

Guns: 4—4.7-inch.

6 smaller.

Torpedo tubes: 8—21-inch.

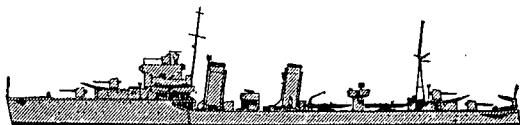

EXPRESS (Note mainmast and whaler on fo'c'sle.)



Destroyer, Eclipse and Fearless Classes.

BRITISH NAVY

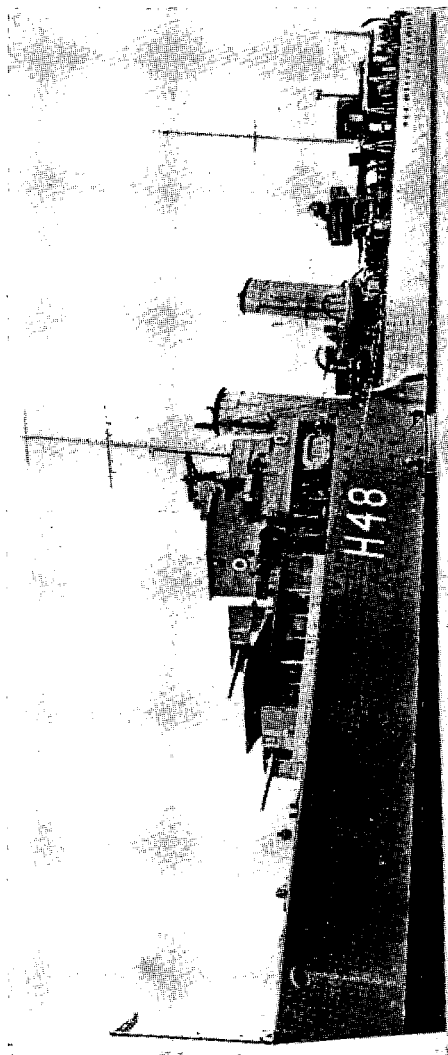

Destroyer FRASER, of Canadian Navy, sunk by collision, 1940. (Appearance of Defender Class like FRASER.)

Destroyers
Defender Class
(4 ships)

DEFENDER
DIAMOND
DECOY
DAINTY

Description: Displacement: 1,375 tons.
Length: 326 feet (waterline).
Beam: 33 feet.
Draft: 8½ feet (mean).
Speed: 36 knots.

Guns: 4—4.7-inch.
6 smaller.

Torpedo tubes: 8—21-inch.

BRITISH NAVY

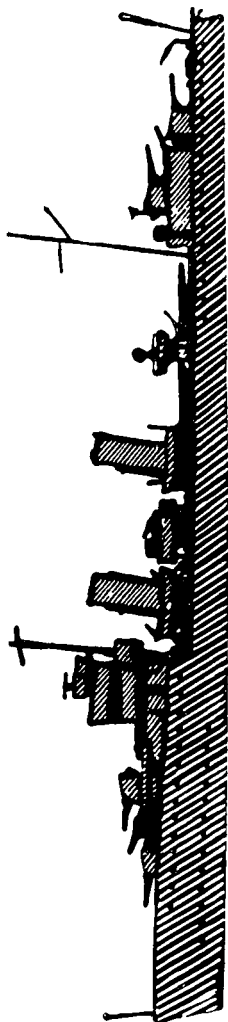
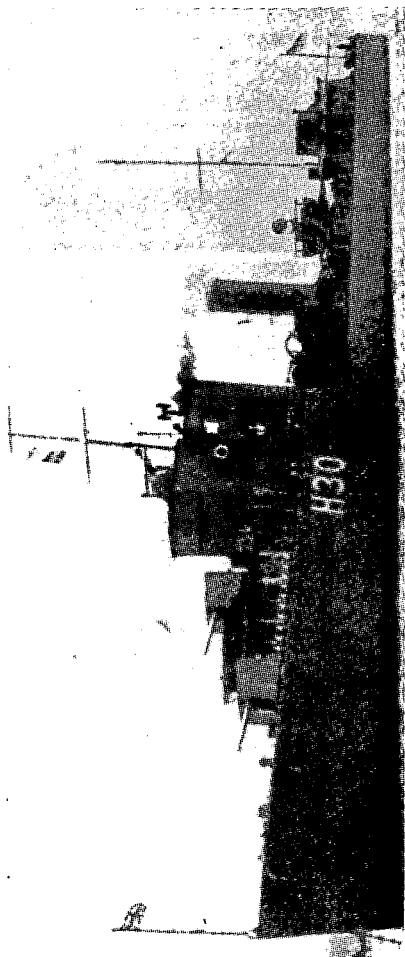

Destroyer BEAGLE and silhouette Achates and Beagle Classes.

IDENTIFICATION OF BRITISH NAVAL SHIPS

Destroyers
Beagle and
Achates classes
(10 ships)

BEAGLE
BOADICEA
BOREAS
BRILLIANT

BULLDOG
ACHATES
ACTIVE
ANTELOPE

ANTHONY
ARROW

Description: Displacement: 1,360 tons (Beagle Class).
1,350 tons (Achates Class).

Length: 323 feet (over-all).

Beam: 32¼ feet.

Draft: 8½ feet (mean).

Speed: 35 knots.

Guns: 4—4.7-inch.
6 smaller.

Torpedo tubes: 8—21-inch (quadrupled).



Destroyer, Beagle and Achates Classes.

BRITISH NAVY

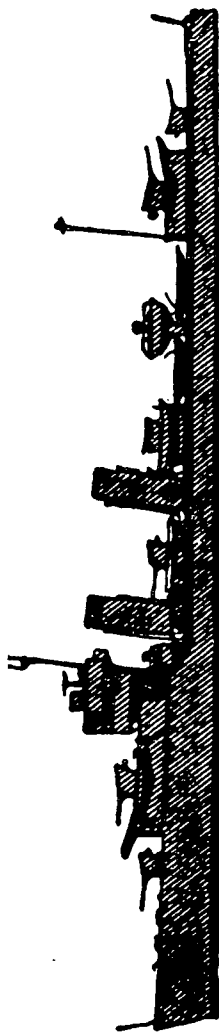
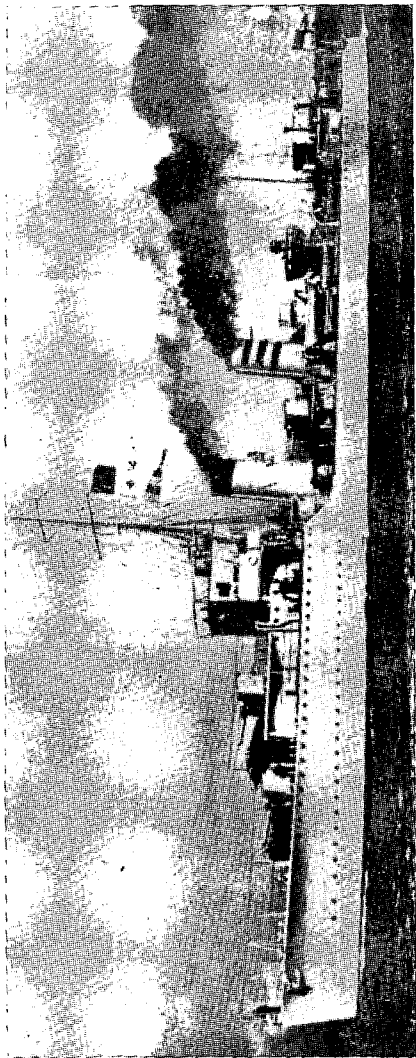

Destroyer CODRINGTON.

IDENTIFICATION OF BRITISH NAVAL SHIPS

Destroyer
"A" Type Leader
CODRINGTON

CODRINGTON

Description: Displacement: 1,540 tons.

Length: 332 feet.

Beam: 33 $\frac{3}{4}$ feet.

Draft: 9 feet (mean).

Speed: 35 knots.

Guns: 5—4.7-inch.

6 smaller.

Torpedo tubes: 8—21-inch (quadrupled).



Destroyer, "A" Type Leader, CODRINGTON.

BRITISH NAVY

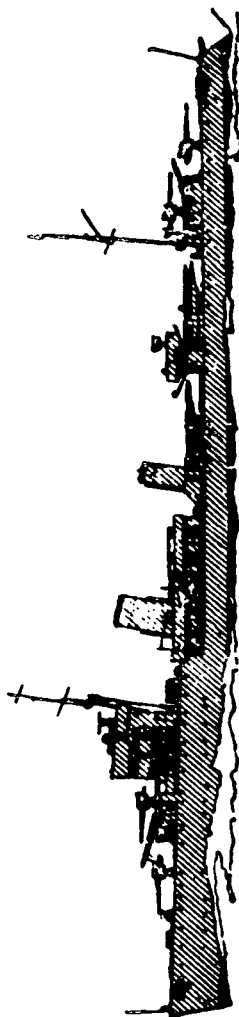
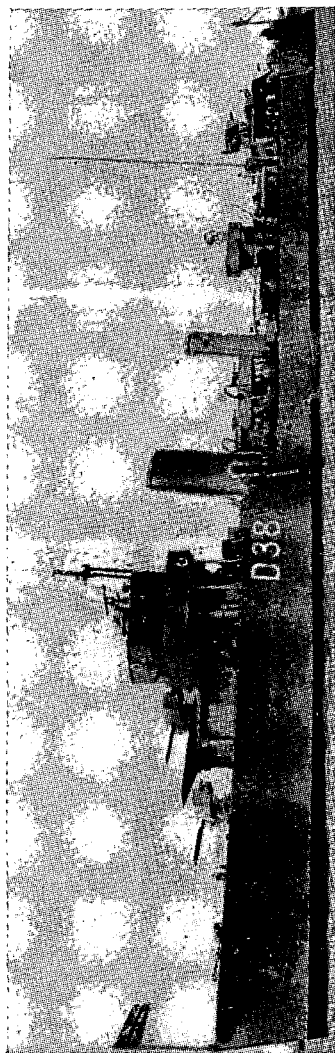

Destroyer AMBUSCADE.

Destroyers
"A" Type

AMAZON
AMBUSCADE

Description: Displacement: 1,350 tons AMAZON.

1,170 tons AMBUSCADE.

Length: 311 $\frac{3}{4}$ feet (between perpendiculars)
AMAZON.

307 feet (between perpendiculars)
AMBUSCADE.

Beam: 31 $\frac{1}{2}$ feet AMAZON.

31 feet AMBUSCADE.

Draft: 9 $\frac{1}{6}$ feet (mean) AMAZON.

8 $\frac{1}{4}$ feet (mean) AMBUSCADE.

Speed: 37 knots (made on trial).

Guns: 4—4.7-inch,
6 smaller.

Torpedo tubes: 6—21-inch (tripled).



Destroyer, "A" Type.

BRITISH NAVY

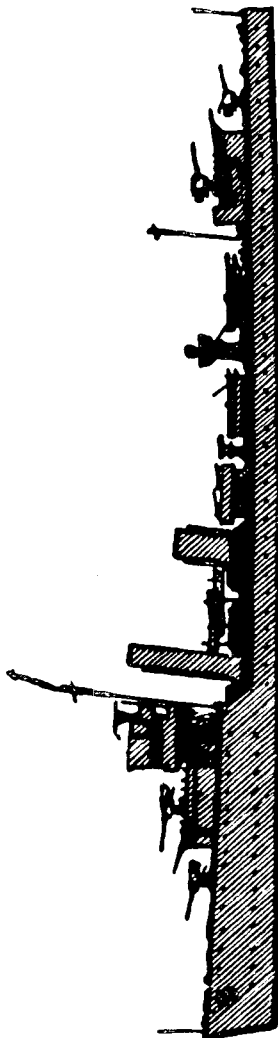
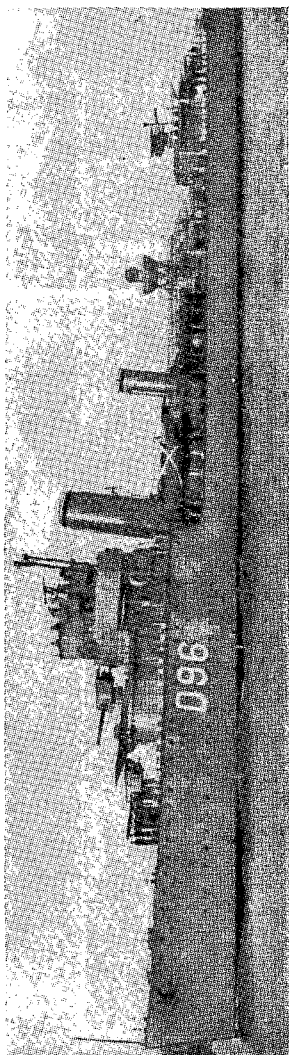

Destroyer WORCESTER and silhouette of Vansittart Group.

IDENTIFICATION OF BRITISH NAVAL SHIPS

Destroyers
Admiralty "Modified W" Class
(13 ships)

Veteran Group:

VETERAN
WHITSHED
WILD SWAN
WITHERINGTON
WIVERN
WOLVERINE
WORCESTER

Vansittart Group:

VANSITTART
VENOMOUS
VERITY
VOLUNTEER
WANDERER
WHITEHALL

Description: Displacement: 1,500 tons (full load).

Length: 312 feet (over-all).

Beam: 29½ feet.

Draft: 10⁵/₆ feet (mean).

Speed: 34 knots.

Guns: 4—4.7-inch.

2—2-pounder.

1 machine gun.

4 Lewis.

Torpedo tubes: 6—21-inch (tripled).

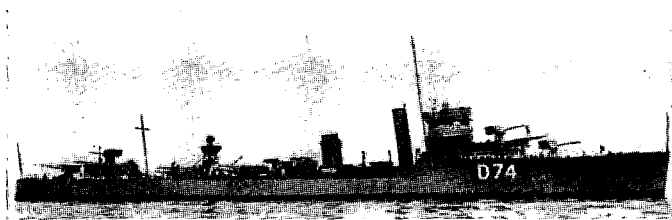

Destroyer WANDERER. (Has the same appearance as the last six of the Admiralty "Modified W" Class.)

BRITISH NAVY

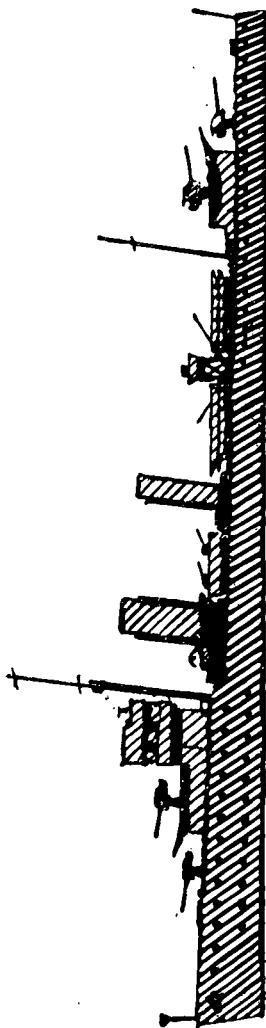
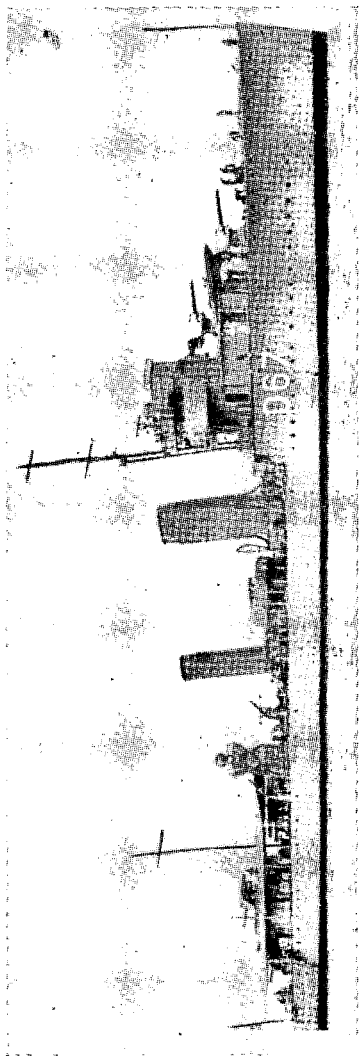

Destroyer WISHART.

BRITISH NAVY

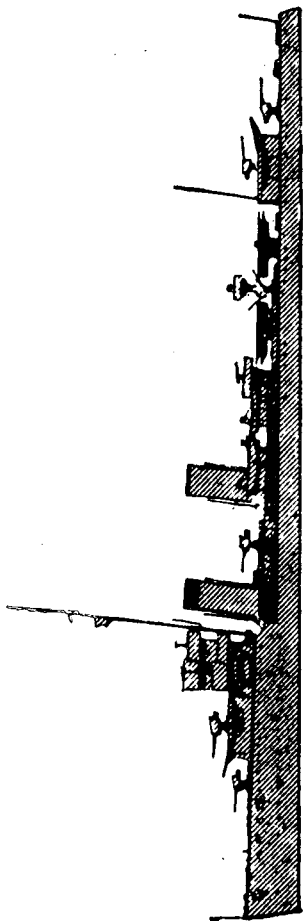
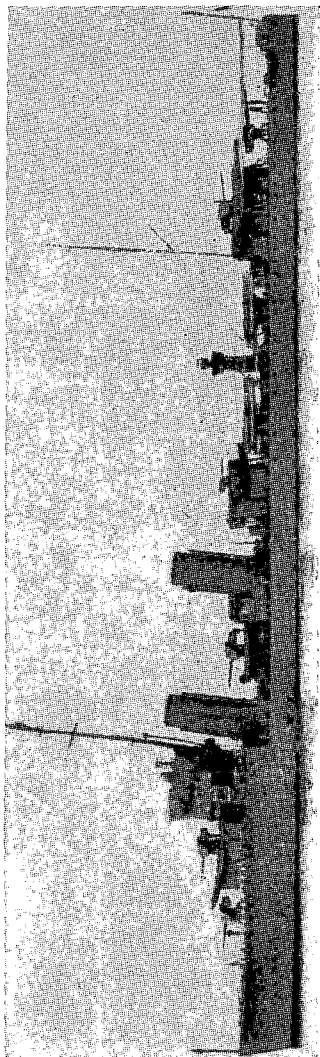

Destroyer BROKE. (Note similarity to ships of Campbell Class.)

Destroyers
Thornycroft Leaders

BROKE
KEPPEL

Description: Displacement: 1,480 tons.
Length, 329 feet (over-all).
Beam: 31 feet 9 inches.
Draft: 12 $\frac{1}{3}$ feet.
Speed: 36 knots.

Guns: 5—4.7-inch.
2—2-pounder.
1 machine gun.
4 Lewis.

Torpedo tubes: 6—21-inch (tripled).

Appearance note: Almost exactly same as Campbell Class.

BRITISH NAVY

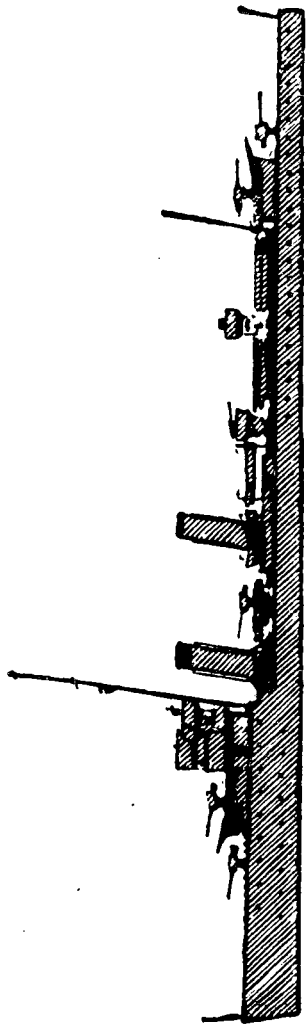
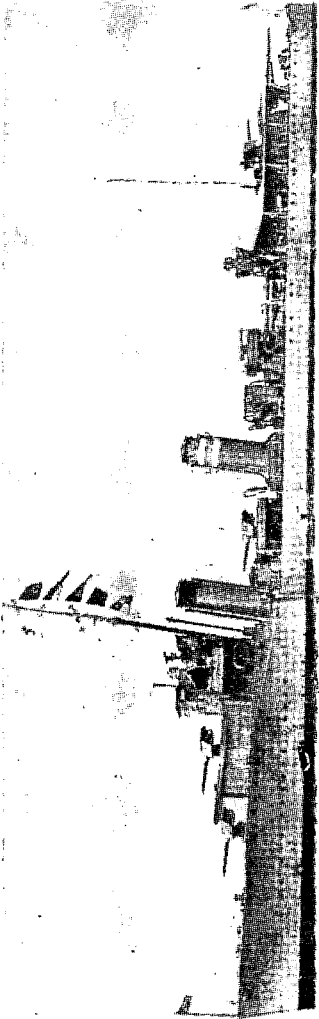

Destroyer CAMPBELL.

IDENTIFICATION OF BRITISH NAVAL SHIPS

Destroyers
Campbell Class
(5 ships)

CAMPBELL
DOUGLAS
MACKAY
MALCOLM
MONTROSE

Description: Displacement: 1,530 tons.
Length: 332½ feet (over-all).
Beam: 31¾ feet.
Draft: 9¼ feet (mean).
Speed: 36.5 knots.

Guns: 5—4.7-inch.
1—3-inch AA.
2—2-pounder AA.
1 machine gun.
4 Lewis.

Torpedo tubes: 6—21-inch (tripled).

Note: Similar to BROKE (p. 158) and to STUART of this class transferred to Royal Australian Navy.

BRITISH NAVY

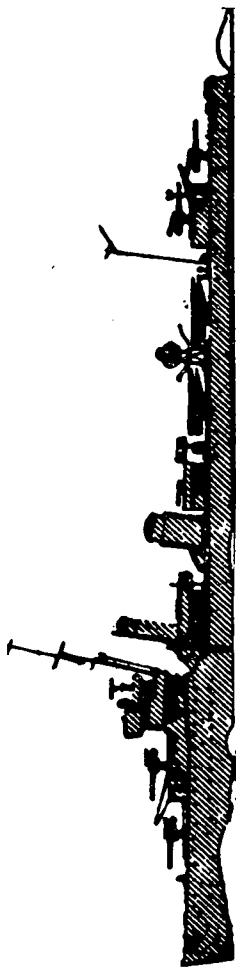

Admiralty "W" Class.

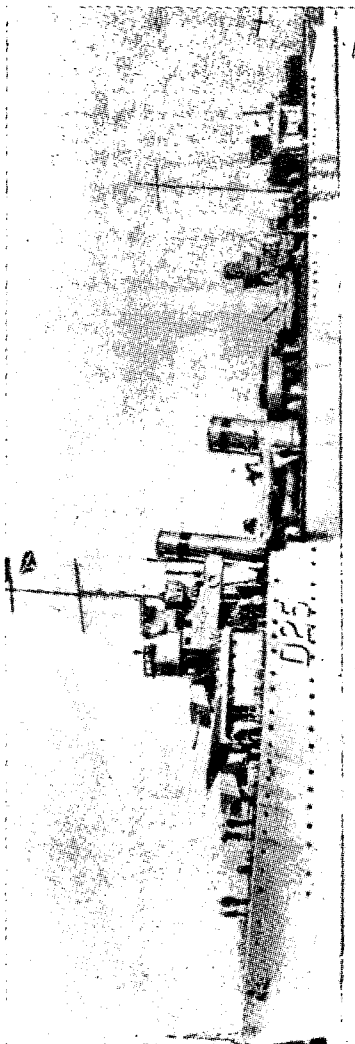

Destroyer WARWICK.

IDENTIFICATION OF BRITISH NAVAL SHIPS

Destroyers
Admiralty "W" Class
(7 ships)

WATCHMAN¹
WALKER¹
WESTCOTT
WALPOLE

WOLFHOUND-
WARWICK¹
WINCHELSEA

Description: Displacement: 1,100 tons.
Length: 312 feet (over-all).
Beam: 29½ feet.
Draft: 10 feet 10 inches (mean).
Speed: 34 knots.

Guns: 4—4-inch.
2—2-pounder pompoms.
1 machine gun.
4 Lewis.

Torpedo tubes: 6—21-inch (tripled).

Appearance note: Identical with Admiralty "V" Class which follows,
except for higher mainmasts.



Destroyer, Admiralty "W" Class.

¹ Fitted as minelayers during war. Still have chutes at stern.

BRITISH NAVY

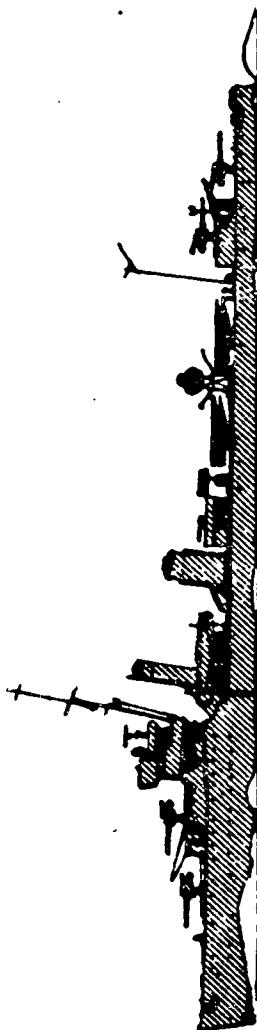
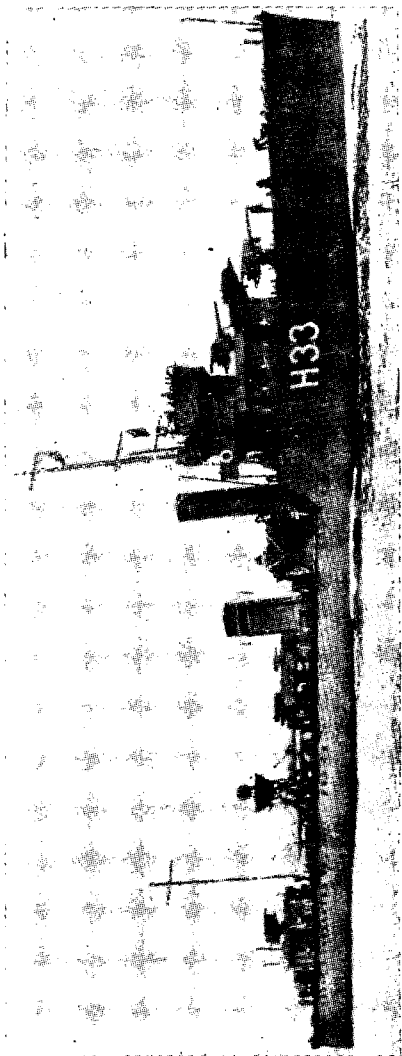

Destroyer VANOC.

IDENTIFICATION OF BRITISH NAVAL SHIPS

Destroyers
Admiralty "V" Class
(12 ships)

VANESSA	VESPER	VIMY
VANITY	VIVACIOUS	VELOX
VERDUN	VANQUISHER	VERSATILE
VIDETTE	VANOC	VORTIGERN

Description: Displacement: 1,480 tons (deep load).
Length 312 feet (over-all).
Beam: 29½ feet.
Draft: 10 feet 10 inches (mean).
Speed: 34 knots.

Guns: 4—4-inch.
1—2-pounder pompom.
1 machine gun.
4 Lewis.

Torpedo tubes: 6—21-inch (first 7 ships).
5—21-inch (last 5 ships).

Appearance note: First 7 ships identical to those of Admiralty "W" Class except for shorter mainmast (VANQUISHER has high mainmast).

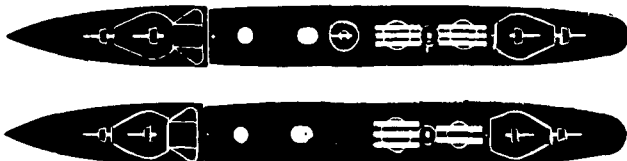

Destroyers, Admiralty "V" Class.

BRITISH NAVY

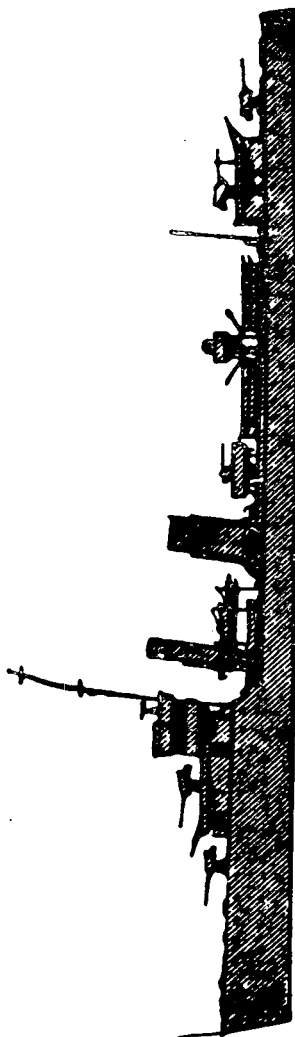
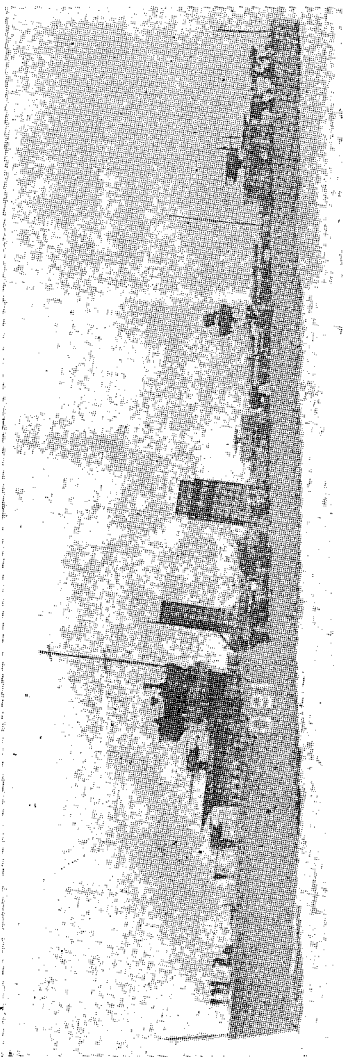

Destroyer VICEROY.

IDENTIFICATION OF BRITISH NAVAL SHIPS

Destroyers
Thornycroft "V" Class

VICEROY
VISCOUNT

Description: Displacement: 1,120 tons.
Length: 312 feet (over-all).
Beam: $30\frac{7}{12}$ feet.
Draft: $10\frac{3}{4}$ feet (mean).
Speed: 35 knots.

Guns: 4—4-inch.
1—2-pounder pompom.
1 machine gun.
4 Lewis.

Torpedo tubes: 6—21-inch (tripled).

Note: Plan is the same as six-tube ship's of Admiralty "V" Class.



Destroyer, Thornycroft "V" Class.

BRITISH NAVY

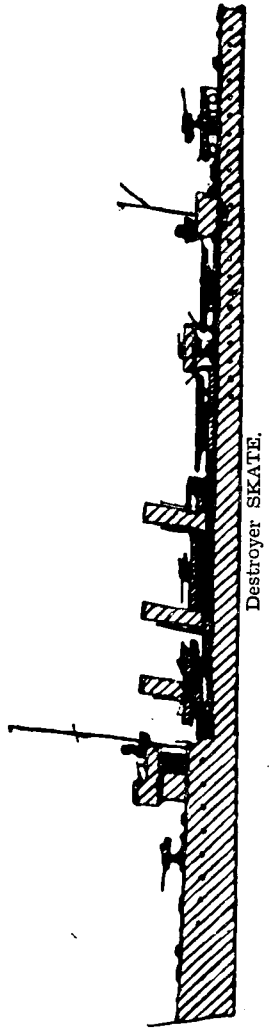
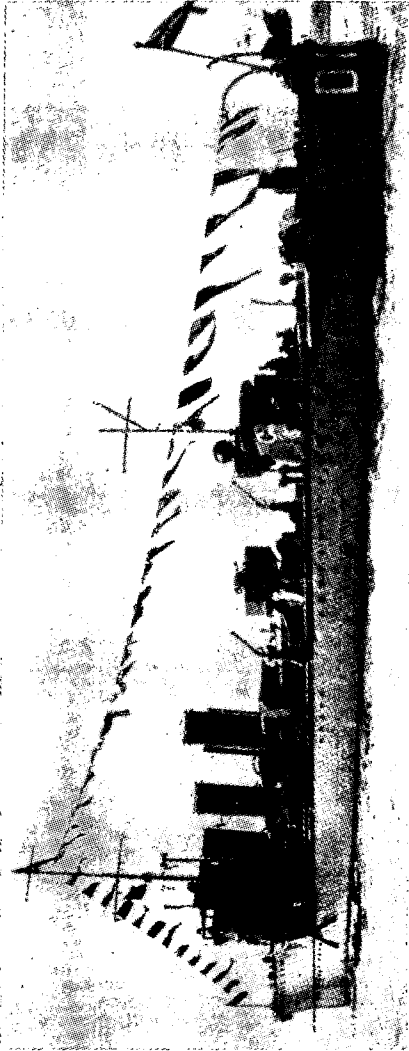

IDENTIFICATION OF BRITISH NAVAL SHIPS

Destroyer
Admiralty "R" Class

SKATE

Description: Displacement: 900 tons.
Length 276 feet (over-all).
Beam: 26 $\frac{3}{4}$ feet.
Draft: 10 $\frac{2}{3}$ feet (mean).
Speed: 31 knots.

Guns: 3—4-inch.
1—2-pounder pompom.
1 machine gun.
4 Lewis.

Torpedo tubes: 4—21-inch (paired).



Destroyer, Admiralty "R" Class.

BRITISH NAVY

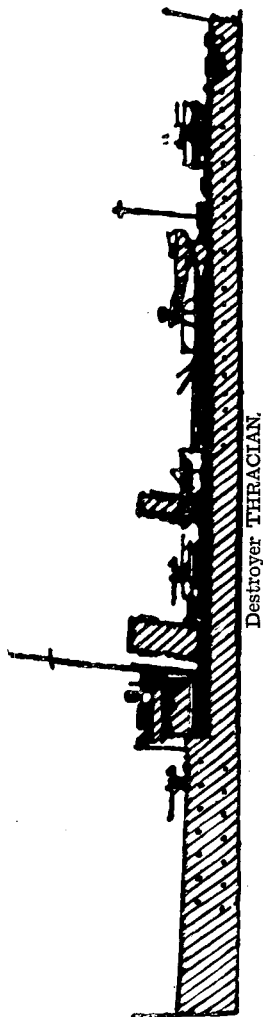
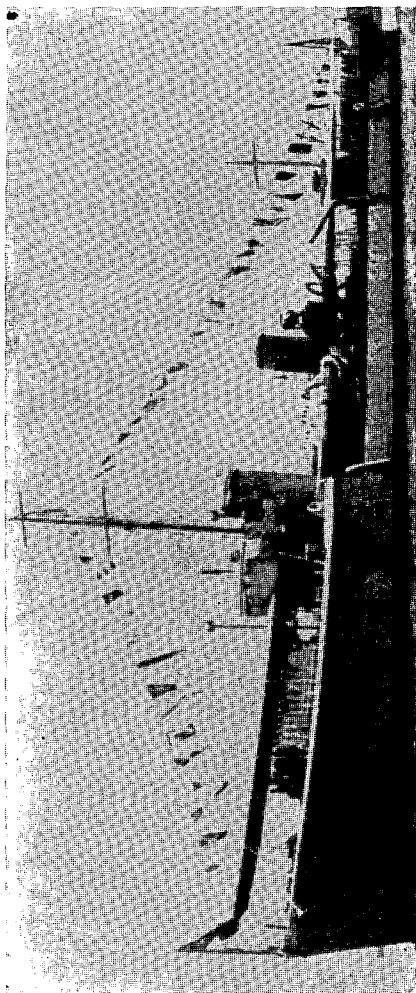

IDENTIFICATION OF BRITISH NAVAL SHIPS

Destroyers
Admiralty "S" Class
(10 ships)

SCIMITAR
SCOUT
THANET
THRACIAN

TENEDOS
STRONGHOLD
SABRE
SALADIN

SARDONYX
SHIKARI

Description: Displacement: 905 tons.
Length: 276 feet (over-all).
Beam: 26 $\frac{3}{4}$ feet.
Draft: 10 $\frac{5}{6}$ feet (mean).
Speed: 31 knots.

Guns: 3—4-inch.
5 smaller.

Torpedo tubes: 4—21-inch (paired).



Destroyer, Admiralty "S" Class.

BRITISH NAVY

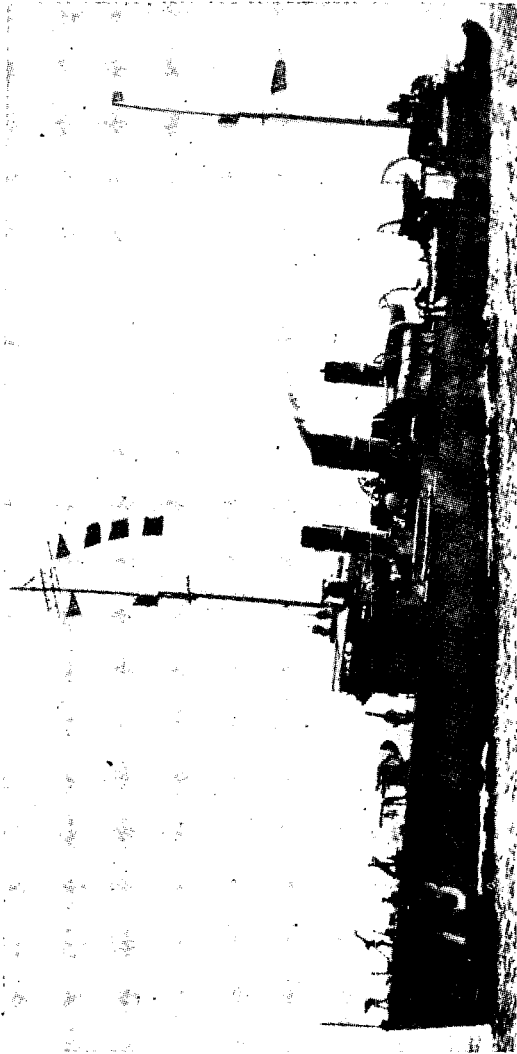

Destroyer MANSFIELD; ex-American "Flush Deck" type. With the exception of the above MANSFIELD and the LINCOLN, all ships in this category have four funnels.

IDENTIFICATION OF BRITISH NAVAL SHIPS

Destroyers
Ex-American "Flush Deck" Type
(44 ships)

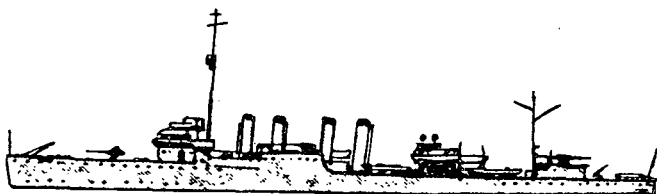

BURNHAM	SHERWOOD	BATH
BELMONT	STANLEY	BRIGHTON
BEVERLEY	WELLS	CHARLESTOWN
BRADFORD	CALDWELL	GEORGETOWN
BROADWATER	CAMPBELTOWN	HAMILTON
BROADWAY	CASTLETON	NEWPORT
BURWELL	CHELSEA	RAMSEY
BUXTON	LANCASTER	READING
CAMERON	LEAMINGTON	ROXBOROUGH
CHESTERFIELD	LEEDS	ST. ALBANS
CHURCHILL	LEWES	ST. MARY'S
CLARE	MONTGOMERY	LINCOLN
NEWARK	RICHMOND	LUDLOW
NEWMARKET	RIPLEY	MANSFIELD
SALISBURY	ROCKINGHAM	

Note: Fifty destroyers were sold by the United States in September 1940. The British Navy received 44 and 6 were acquired by the Canadian Navy (2 now the St. Croix Class and 4 the Annapolis Class).

MILITARY INTELLIGENCE

BRITISH NAVY

Light Destroyers
Hunt Class

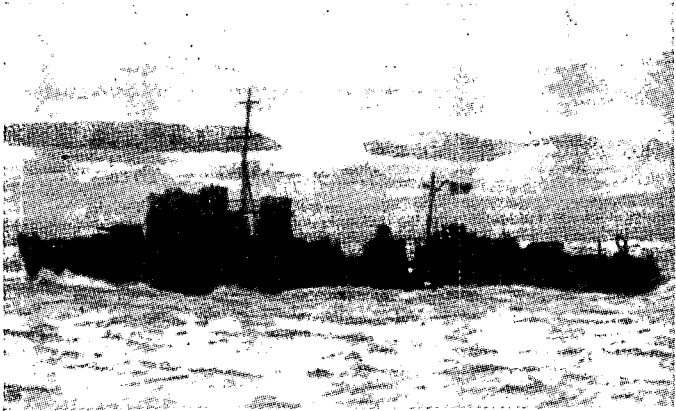

(All laid down in 1939 and completed in 1940)

ATHERSTONE	EXMOOR	PYTCHLEY
BERKELEY	FERNIE	QUANTOCK
CATTISTOCK	GARTH	QUORN
CLEVELAND	HAMBLEDON	SOUTHDOWN
COTSWOLD	HOLDERNESS	TYNEDALE
COTTESMORE	MENDIP	WHADDON
EGLINTON	MEYNELL	

Description: Displacement: 904 tons.

Length: 272 $\frac{1}{3}$ feet.

Beam: 28 $\frac{1}{4}$ feet.

Draft: 7 $\frac{3}{4}$ feet.

Speed: 32.5 knots.

Guns: 4—4-inch AA.

8 smaller.

Torpedo Boats

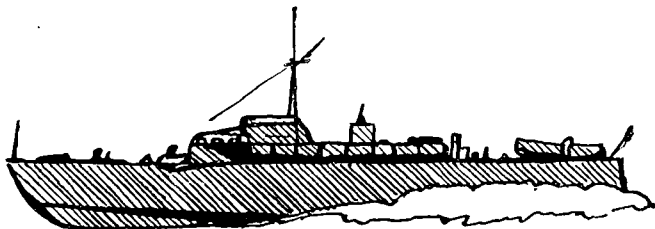
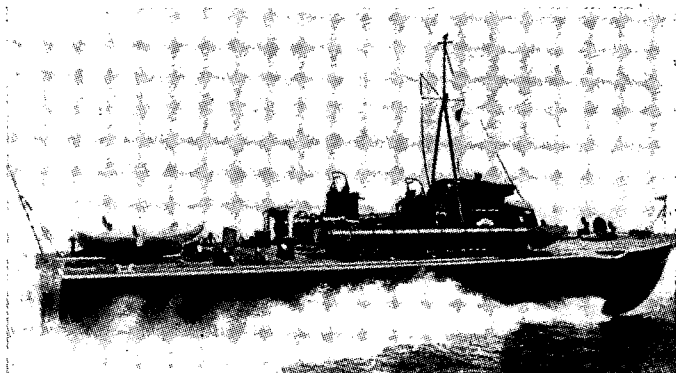

Torpedo Boat No. 22.

Nos. 22, 24, 25

Description: Displacement: 32 tons.

Length: 72 feet.

Beam: $16\frac{1}{2}$ feet.

Draft: $3\frac{3}{4}$ feet.

Speed: Over 40 knots.

Guns: 2 machine guns, AA.

Torpedo tubes: 2—21-inch.

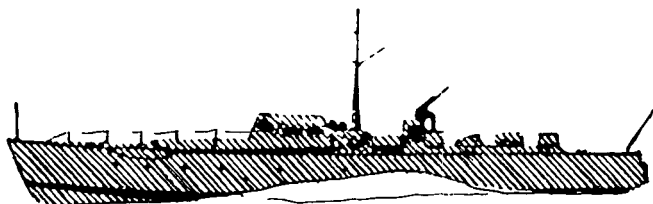
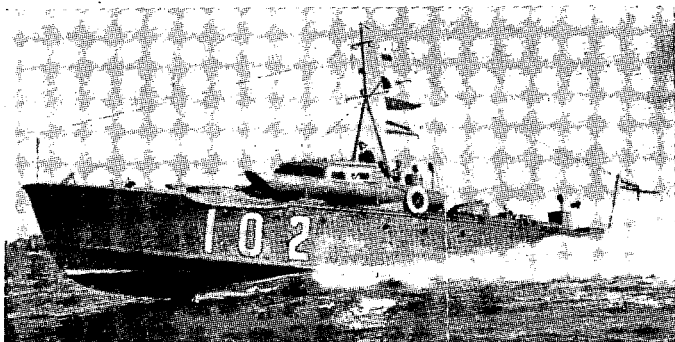

Torpedo Boat No. 102.

Nos. 101, 102, 103

Description: Displacement: 28 tons.

22 tons for 101.

Length: 68 feet.

Beam: $14\frac{3}{4}$ feet.

Draft: $3\frac{1}{6}$ feet.

Speed: 43.7 knots.

40 knots for 101.

Guns: 2—20-mm.

Torpedo tubes: 2—21-inch.

IDENTIFICATION OF BRITISH NAVAL SHIPS

Torpedo Boats

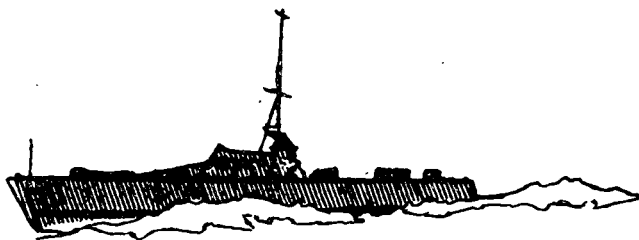
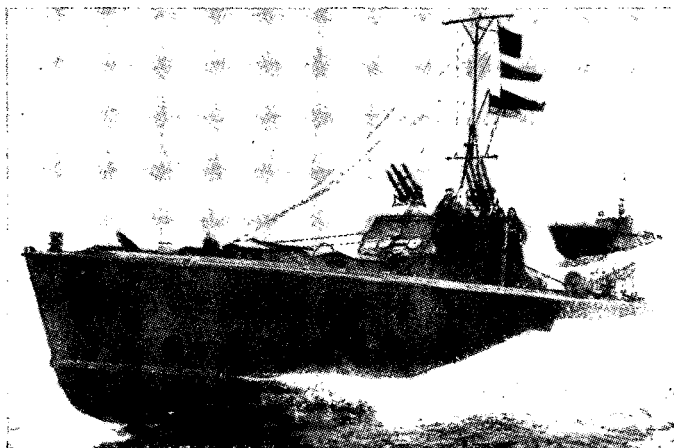

Torpedo Boat No. 18

Nos. 100	5	10	16
	1	6	11
	2	7	12
	3	8	14
	4	9	15

(There is no No. 13)

Description: Displacement: 18 tons.

Length: 60 feet.

Beam: $13\frac{1}{4}$ feet.

Draft: $2\frac{5}{6}$ feet.

Speed: 35 knots.

Guns: 8 Lewis (quadrupled).

Torpedo tubes: 2—18-inch.

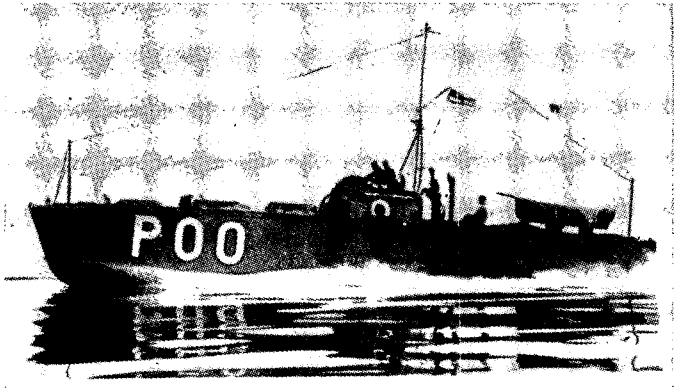

Power Boat, M. A. S. B. 1.

M. A. S. B. Nos. 1, 2, 3, 4, 5, 6

Description: Displacement: 18 to 20 tons.

Length: 60 feet.

Beam: 13¼ feet.

Draft: 3 feet.

Speed:

Guns:

Torpedo tubes:

IDENTIFICATION OF BRITISH NAVAL SHIPS

Submarines
Triton Class

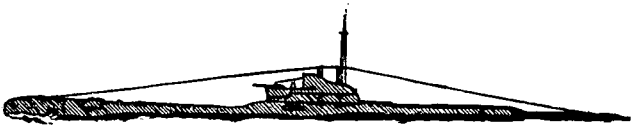
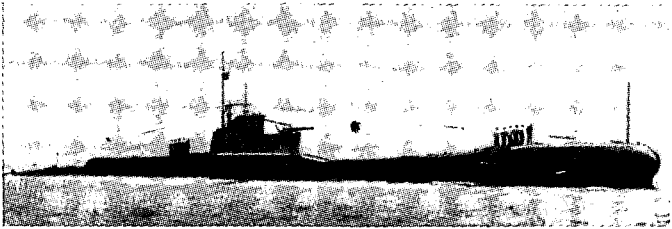

Submarine TRIUMPH.

Triton class

TIGRIS	TRUANT	TALISMAN
TORBAY	TETRARCH	THUNDERBOLT
TRITON	TRIDENT	TRIBUNE
TRIUMPH	TAKU	TUNA

(4 more authorized under 1939 estimates.)

Description: Displacement: 1,090 tons.

Length: 275 feet (over-all).

Beam: 26½ feet.

Draft: 12 feet.

Speed: 15.25 knots (9 submerged).

Guns: 1—4-inch.

2 smaller.

Torpedo tubes: 10—21-inch.

BRITISH NAVY

Submarines
Porpoise Class
(Mine layers)

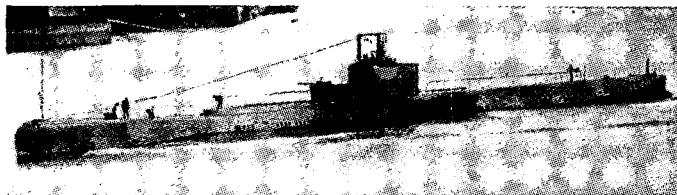

Submarine PORPOISE.

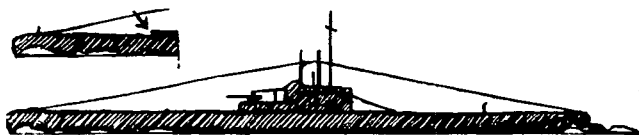

Rorqual Group (PORPOISE as part sketch).

Porpoise Class (Minelayers)

PORPOISE, RORQUAL, CACHALOT

Description: Displacement: 1,500 tons.
Length: 271½ feet (PORPOISE 267).
Beam: 25½ feet (PORPOISE 29⅝).
Draft: 15 feet (PORPOISE 13¾).
Speed: 15.75 knots surface.
15 knots surface, PORPOISE.
8.75 knots submerged.

Guns: 1—4-inch.

2 machine guns.

Torpedo tubes: 6—21-inch (bow).

IDENTIFICATION OF BRITISH NAVAL SHIPS

Submarines
Severn Class

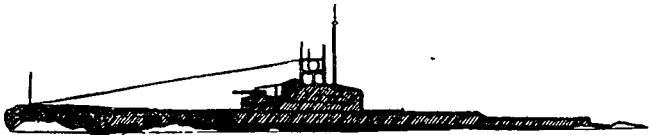
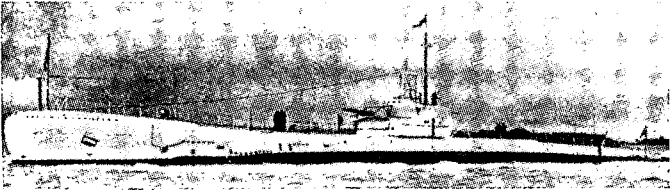

Severn Class

SEVERN
CLYDE

Description: Displacement: 1,850 tons.
Length: 325 feet.
Beam: 28 feet.
Draft: 13 feet.
Speed: 22.25 knots surface,
10 knots submerged.

Guns: 1—4-inch.
2 machine guns.
Torpedo tubes: 6—21-inch (bow).

BRITISH NAVY

Submarines
Regent Class

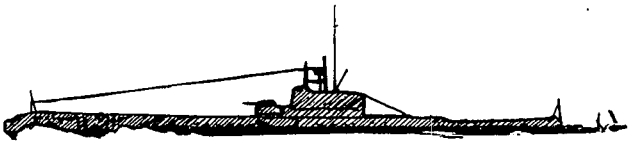
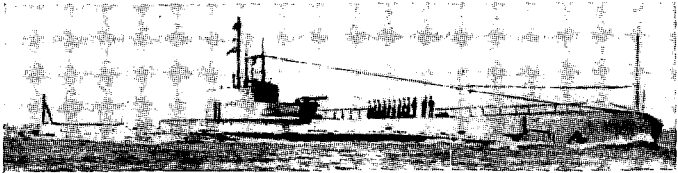

Submarine ROVER.

Regent Class

REGENT
ROVER

Description: Displacement: 1,475 tons.
Length: 260 feet.
Beam: 28 feet.
Draft: 13 feet 10 inches.
Speed: 17.5 knots (9 submerged).
Guns: 1—4-inch.
2 machine guns.
Torpedo tubes: 8—21-inch.

IDENTIFICATION OF BRITISH NAVAL SHIPS

Submarines
Parthian Class

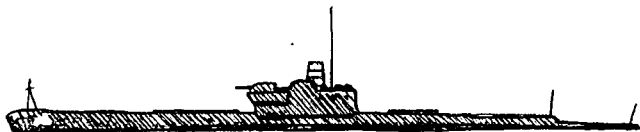
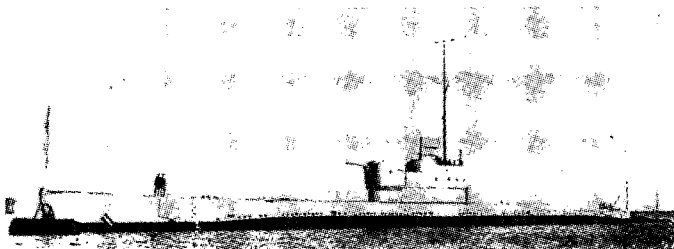

Submarine PERSEUS.

Parthian Class

PARTHIAN
PANDORA

PERSEUS
PROTEUS

Description: Displacement: 1,475 tons.

Length: 260 feet.

Beam: 28 feet.

Draft: 13½ feet.

Speed: 17.5 knots surface.

9.0 knots submerged.

Guns: 1—4-inch.

2 machine guns.

Torpedo tubes: 8—21-inch.

BRITISH NAVY

Submarines
Olympus Class

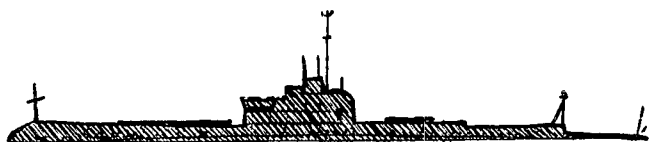
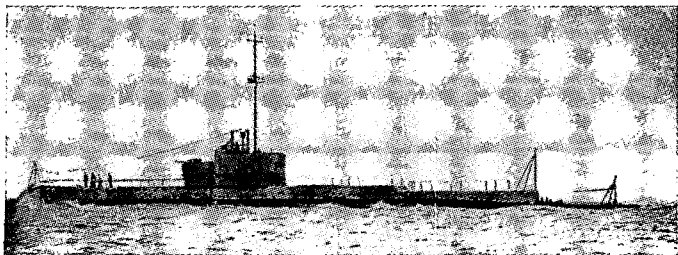

Submarine OLYMPUS.

Olympus Class

OLYMPUS

OSIRIS

OTUS

Description: Displacement: 1,475 tons.
Length: 283½ feet (over-all).
Beam: 28 feet.
Draft: 13½ feet (mean).
Speed: 17.5 knots surface.
9 knots submerged.

Guns: 1—4-inch.

2 machine guns.

Torpedo tubes: 8—21-inch (6 bow, 2 stern).

IDENTIFICATION OF BRITISH NAVAL SHIPS

Submarines
"L" Class

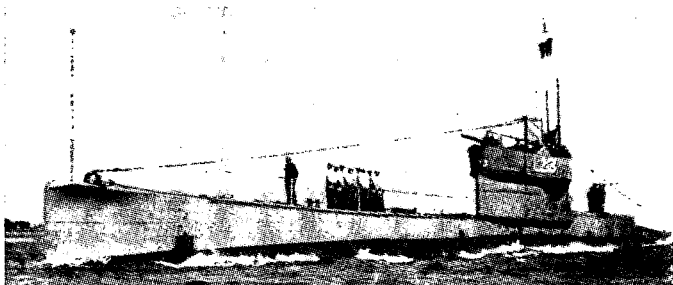

"L" Class

L 23

L 26

L 27

Description: Displacement: 760 tons.
Length: 238½ feet (over-all).
Beam: 23½ feet.
Draft: 13¾ feet.
Speed: 17.5 knots surface.
10.5 knots submerged.

Guns: 1—4-inch.
1 machine gun.

Torpedo tubes: 4—21-inch.

BRITISH NAVY

Submarines
Oberon Class

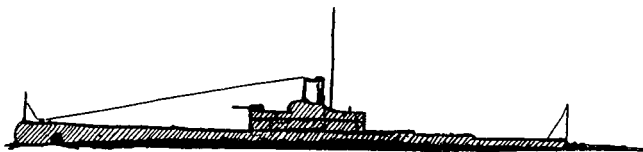
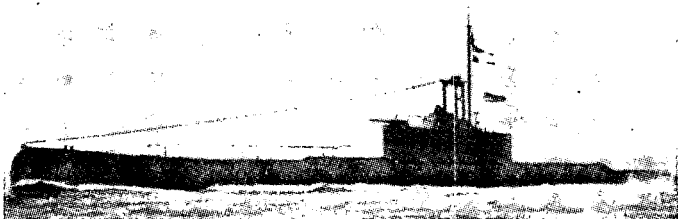

Submarine OBERON.

Oberon Class

OBERON (1,311 tons)

OTWAY (1,349 tons)

Description: Displacement: As above.

Length: 270 feet (over-all).

Beam: 28 feet.

Draft: 13 $\frac{1}{4}$ feet.

Speed: 15 knots surface.

9 knots submerged.

Guns: 1—4-inch.

2 machine guns.

Torpedo tubes: 8—21-inch (6 bow, 2 stern).

IDENTIFICATION OF BRITISH NAVAL SHIPS

Submarines
Sealion Class

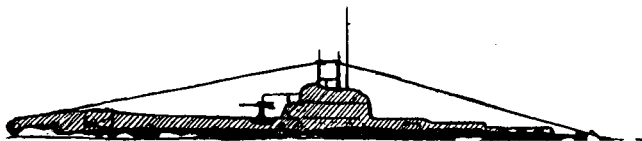
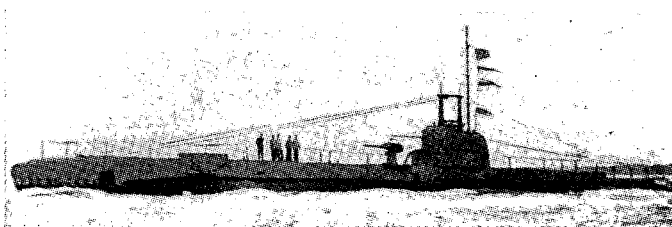

Submarine SEAWOLF.

Sealion Class

SNAPPER
SUNFISH

SEALION
SEAWOLF

STURGEON

Description: Displacement: 670 tons.
Length: 202½ feet (waterline).
Beam: 24 feet.
Draft: 10½ feet (mean).
Speed: 15 knots surface.
10 knots submerged.

Guns: 1—3-inch.
1 machine gun.

Torpedo tubes: 6—21-inch (bow).

BRITISH NAVY

Submarines
Ursula Class

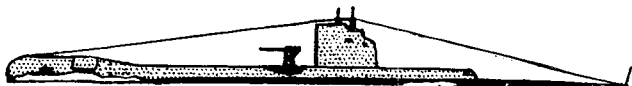
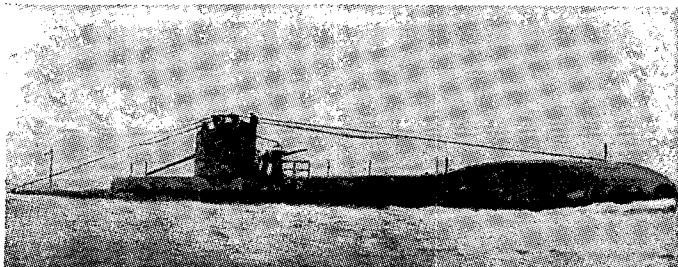

Submarine URSULA.

Ursula Class

UNITY
URSULA

Description: Displacement: 540 tons.
Length: 180 feet.
Beam: 16 feet,
Draft: $12\frac{3}{4}$ feet.
Speed: 11.25 knots surface.
10 knots submerged.

Guns: 1 small.

Torpedo tubes: 6—21-inch.

IDENTIFICATION OF BRITISH NAVAL SHIPS

Submarines
"H" Class

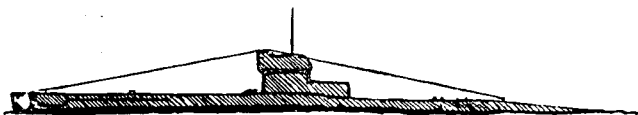
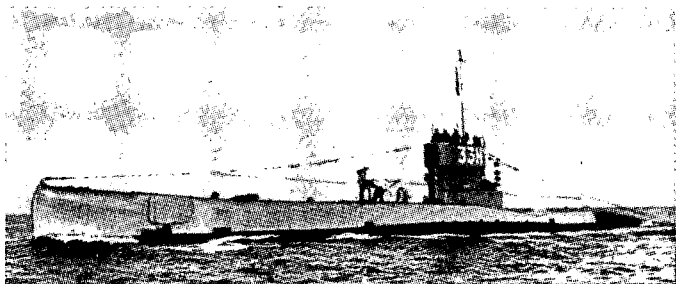

Submarine H. 33.

"H" Class

H 28	H 32	H 34	H 44
H 31	H 33	H 43	H 50

Description: Displacement: 410 tons.
 Length: 170 feet (over-all).
 Beam: $15\frac{3}{4}$ feet.
 Draft: $12\frac{1}{2}$ feet.
 Speed: 13 knots surface.
 10.5 knots submerged.

Guns: 1 machine gun.
 Torpedo tubes: 4—21-inch (bow).

MILITARY INTELLIGENCE

BRITISH NAVY

Escort Vessels
Wallace and Wolsley Types
(12 ships)



VEGA and other rearmed units.

WALLACE	WRYNECK	VIMIERA
WOLSLEY	WINCHESTER	WRESTLER
WOOLSTON	WESTMINSTER	VALOROUS
VEGA	WINDSOR	VIVIEN

Description (WALLACE):

Displacement: 1,250 tons.
Length: 329 feet (over-all).
Beam: 31 $\frac{3}{4}$ feet.
Draft: 12 $\frac{1}{2}$ feet (mean).
Speed: 28 knots.

Description (all except WALLACE):

Displacement: 900 tons.
Length: 312 feet (over-all).
Beam: 30 feet.
Draft: 10 $\frac{3}{4}$ feet (mean).
Speed: 28 knots.

Guns: 4—4-inch,
2 multimachine guns.

Note: All of the above vessels were originally destroyers of 1917 design, but were rearmed for escort duty in 1938-39.

IDENTIFICATION OF BRITISH NAVAL SHIPS

Escort Vessels
Black Swan Class

(Recent construction; no plans or photos.)

Black Swan Class

ERNE
IBIS

BLACK SWAN
FLAMINGO

Description: Displacement: 1,250 tons.

Length:

Beam:

Draft:

Speed: 19.25 knots.

Guns: 6—4-inch AA.
10 smaller.

BRITISH NAVY

Escort Vessels
Egret Class

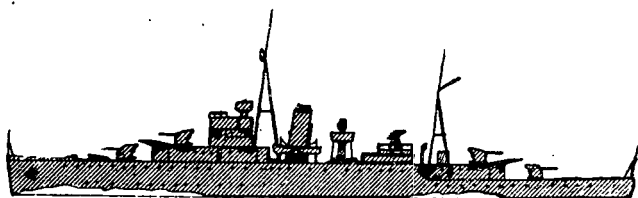
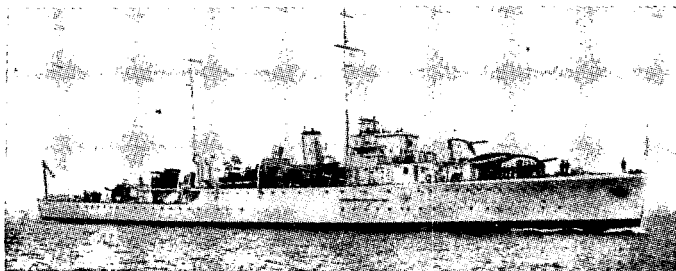

Escort vessel EGRET.

EGRET
AUCKLAND

PELICAN

Description: Displacement: 1,200 tons.
Length: 276 feet (waterline).
Beam: 37½ feet.
Draft: 8½ feet (mean).
Speed: 19.25 knots.

Guns: 8—4-inch AA.
7 smaller.

IDENTIFICATION OF BRITISH NAVAL SHIPS

Escort Vessels
Enchantress Class

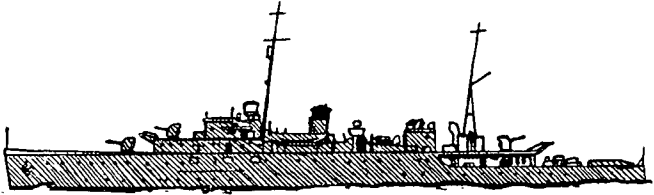

Escort vessel STORK.

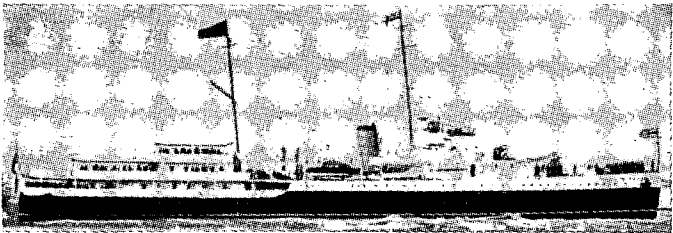

Escort vessel ENCHANTRESS.

ENCHANTRESS

STORK

Description: Displacement: 1,190 tons.
Length: 266 feet (waterline).
Beam: 37 feet.
Draft: 8½ feet (mean).
Speed: 18.75 knots.

Guns:

ENCHANTRESS

4—4.7-inch.
4—3-pounder.
8 smaller.

STORK

6—4-inch AA.
5 smaller.

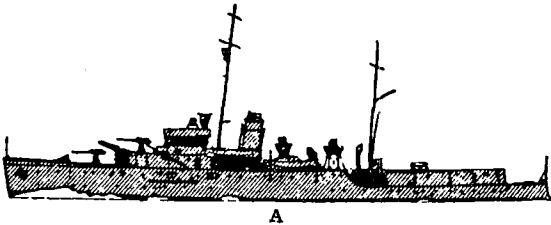

A

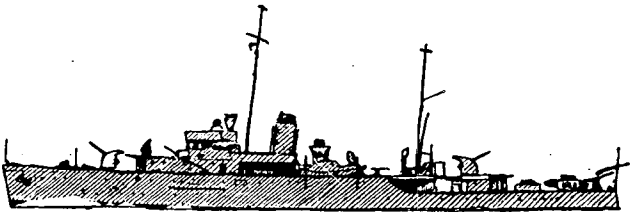

B



C

(A) ABERDEEN. (B) and (C) FLEETWOOD.

FLEETWOOD

ABERDEEN

Description: Displacement: 990 tons.

Length: 266 feet (over-all).

Beam: 36 feet.

Draft: 7½ feet (mean).

Speed: 16.5 knots.

Guns: 4—4-inch AA.

9 smaller.

IDENTIFICATION OF BRITISH NAVAL SHIPS

Escort Vessels
Grimsby Class

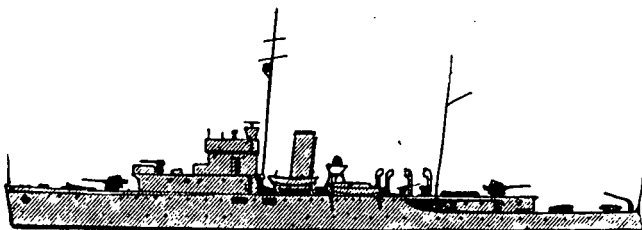
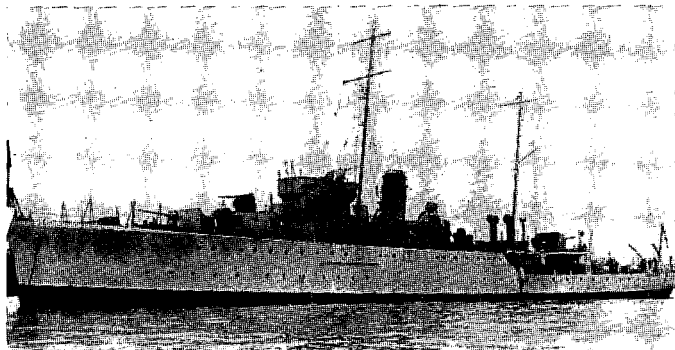

Escort Vessel LOWESTOFT.

Grimsby Class

GRIMSBY	LOWESTOFT	LONDONDERRY
LEITH	WELLINGTON	DEPTFORD

Description: Displacement: 990 tons.
Length: 266 feet (over-all).
Beam: 34 feet.
Draft: $7\frac{1}{4}$ feet (mean).
Speed: 16.5 knots.

Guns: 2—4.7-inch.
1—3-inch A.A.
2—3-pounder (4—3-pounders last two ships).
10 machine guns.

BRITISH NAVY

Escort Vessels

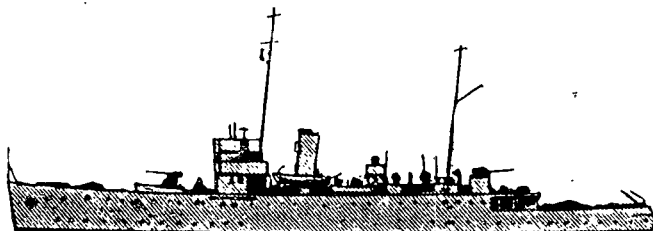
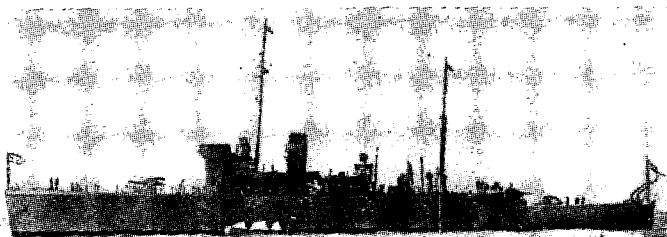

HASTINGS, SHOREHAM Classes.

<i>Classes</i>	<i>Displacement</i> (tons)	<i>Length</i> (over-all) (feet)	<i>Beam</i> (feet)	<i>Draft</i> (feet)
Bridgewater -----	1, 045	266	34	8¼
Hastings -----	1, 025	266	34	8
Shoreham -----	1, 105	266	34	9
Falmouth -----	1, 060	266	34	8¾

BRIDGEWATER HASTINGS SHOREHAM FALMOUTH
 SANDWICH ROCHESTER MILFORD
 FOWEY WESTON
 BIDEFORD

Guns: 2—4-inch AA. (HASTINGS and FALMOUTH,
 1—4-inch AA.)
 9 to 13 smaller.

IDENTIFICATION OF BRITISH NAVAL SHIPS

Escort Vessels
"Flower" Class

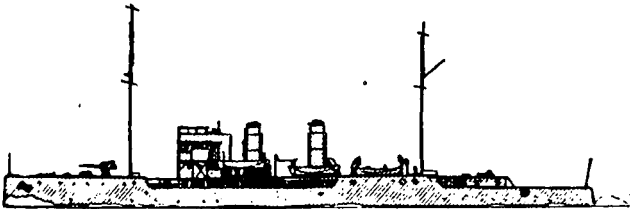
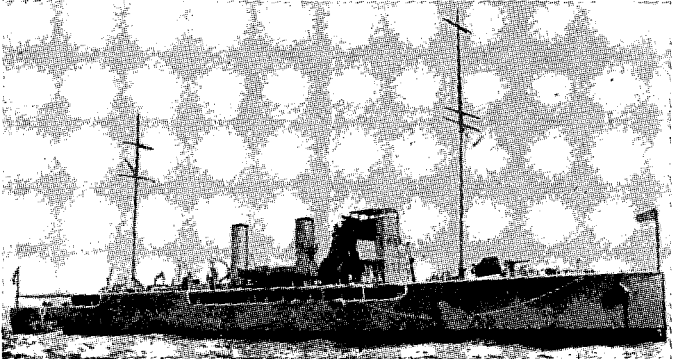

Escort vessel LUPIN.
"Flower Class.

LUPIN
FOXGLOVE
ROSEMARY

Description: Displacement: 1,175 tons.
Length: 267 $\frac{3}{4}$ feet (over-all).
Beam: 33 $\frac{1}{2}$ feet.
Draft: 11 feet.
Speed: 16.5 knots (FOXGLOVE 16).
Guns: 1—4-inch (FOXGLOVE, 2—4-inch).
12 smaller (FOXGLOVE, 16 smaller).

MILITARY INTELLIGENCE

BRITISH NAVY

Patrol Vessels
Guillemot Class

(Recent construction. No photos. They are believed to be an improvement on WIDGEON design.)

Guillemot Class

GUILLEMOT

PINTAIL

SHEARWATER

Description: Displacement: 580 tons.

Guns: 1—4-inch AA.

IDENTIFICATION OF BRITISH NAVAL SHIPS

Patrol Vessels
Kingfisher Class

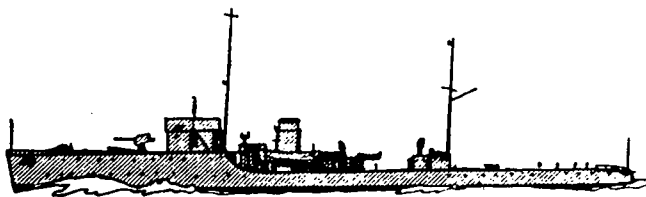
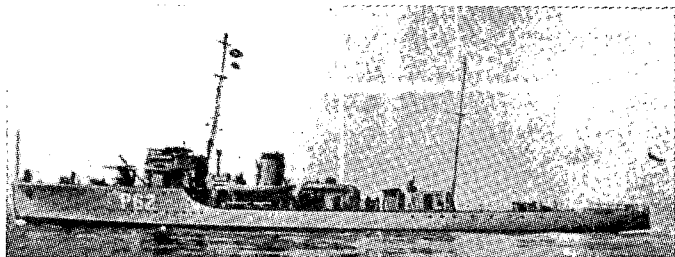

Patrol vessel WIDGEON (bridge now covered in).

Kingfisher Class

KINGFISHER (510 tons)	KITTIWAKE (530 tons)
MALLARD (510 tons)	SHELDRAKE (530 tons)
PUFFIN (510 tons)	WIDGEON (530 tons)

Description: Displacement: As above.
Length: $243\frac{1}{6}$ feet (over-all).
Beam: $26\frac{1}{2}$ feet.
Draft: 6 feet.
Speed: 20 knots.

Guns: 1—4-inch AA.
8 smaller.

BRITISH NAVY

Patrol Vessels P. C. 74

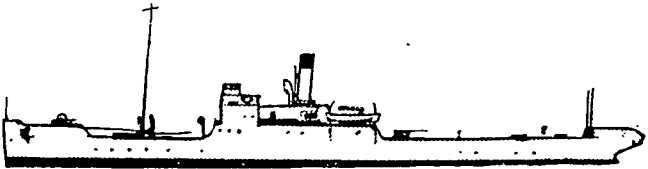
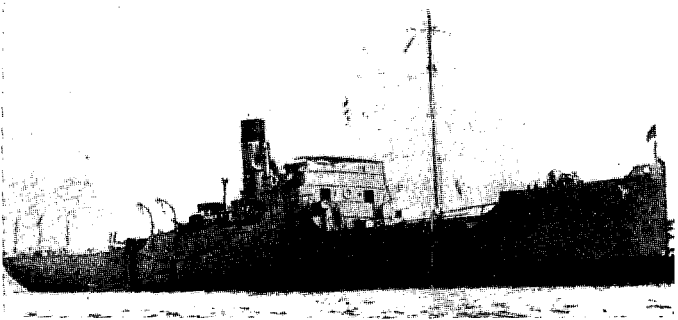

Patrol vessel P. C. 74.

P. C. 74

Description: Displacement: 610 tons.
Length: 247 feet (over-all).
Beam: $26\frac{3}{4}$ feet.
Draft: 8 feet.
Speed: 20 knots.

Guns: 1—4-inch.
24—30 depth charges.

IDENTIFICATION OF BRITISH NAVAL SHIPS

Minesweepers
Bangor Class
(20 ships)

(Recent construction; photos not available. Will replace old vessels of Improved Hunt Class.)

Bangor Class (20 ships)

BANGOR	PETERHEAD	ROTHESAY
BLACKPOOL	BEAUMARIS	TENBY
BRIDLINGTON	BOSTON	RHYL
BRIDPORT	POLRUAN	ROMNEY
BLYTH	RYE	SIDMOUTH
CROMARTY	ILFRACOMBE	STORNOWAY
DUNBAR	LLANDUDNO	

No particulars of these vessels have been released.

BRITISH NAVY

Minesweepers
Halcyon Class

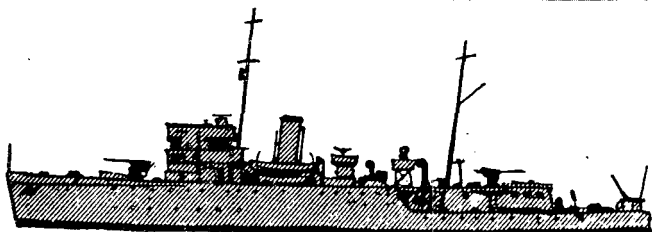
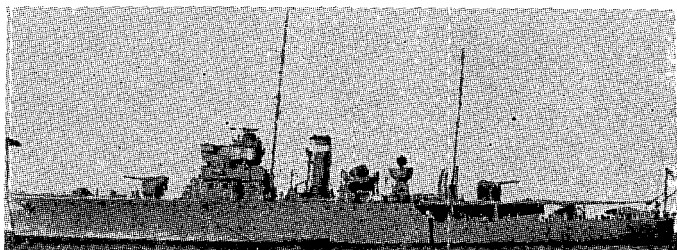

Minesweeper SHARPSHOOTER.

Halcyon Class

HALCYON	SHARPSHOOTER (835
HARRIER	tons)
HUSSAR	LEDA
SPEEDWELL	SEAGULL
GOSSAMER	BRAMBLE (875 tons)
SPEEDY (875 tons)	BRITOMART (875 tons)
NIGER	HAZARD (835 tons)
SALAMANDER	GLEANER (835 tons)
HEBE (835 tons)	JASON (835 tons)

Description: Displacement: 815 tons (except as above).

Length: 230 feet.

Beam: 33½ feet.

Draft: 7 feet.

Speed: 17 knots.

Guns: 2—4-inch AA.

5 smaller.

IDENTIFICATION OF BRITISH NAVAL SHIPS

Minesweepers
Improved Hunt Class
(21 ships)

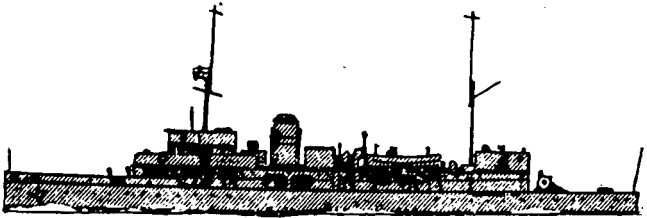

SALT BURN—Improved Hunt Class.

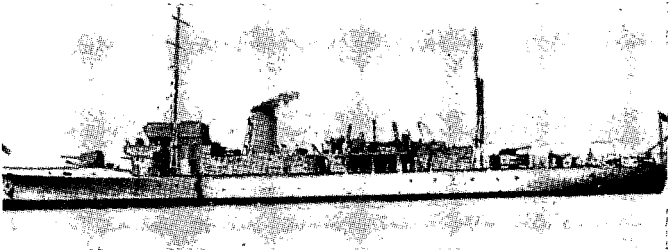

Minesweeper SELKIRK.

Improved Hunt Class (21 ships)

ABERDARE	FERMOY	SALT BURN
ABINGDON	HARROW	SELKIRK
ALBURY	HUNTLY	STOKE
ALRESFORD	LYDD	SUTTON
BAGSHOT	PANGBOURNE	ELGIN
DERBY	ROSS	TEDWORTH
FAREHAM	SALTASH	WIDNES

Description: Displacement: 710 tons (TEDWORTH, 675 tons).

Length: 231 feet (over-all).

Beam: $28\frac{3}{8}$ feet.

Draft: $7\frac{1}{2}$ feet.

Speed: 16 knots.

Guns: 1—4-inch.

1 smaller.

Note: There are minor variations in the ships of this class.

BRITISH NAVY

Motor Minesweepers

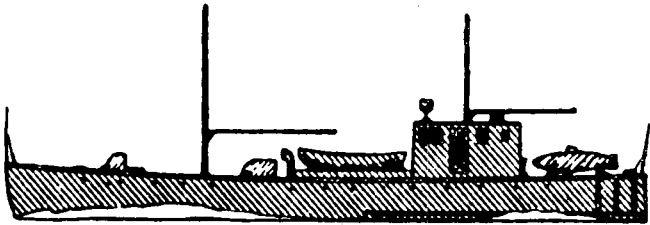
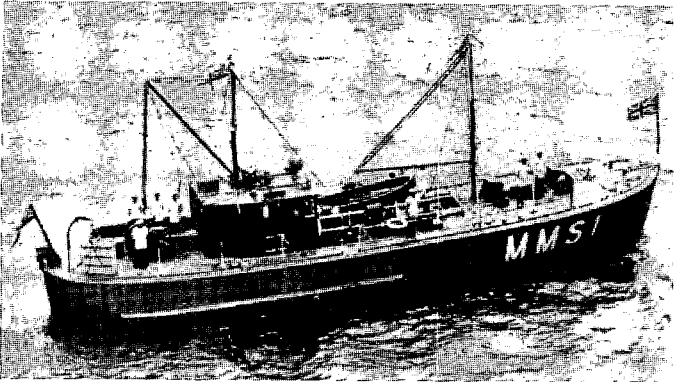

Motor Minesweeper M. M. S. 1.

M. M. S. Class

M. M. S. 1

M. M. S. 2

Description: Displacement: 52 tons.

Length: 75 feet.

Beam: 14 $\frac{1}{3}$ feet.

Draft: 5 feet (maximum).

Speed: 15 knots (reduced to 10 knots when sweeping).

Training Ship

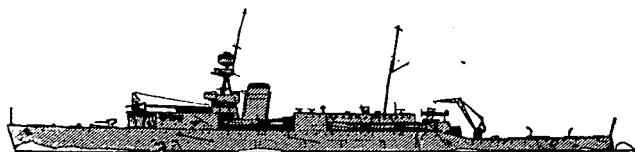
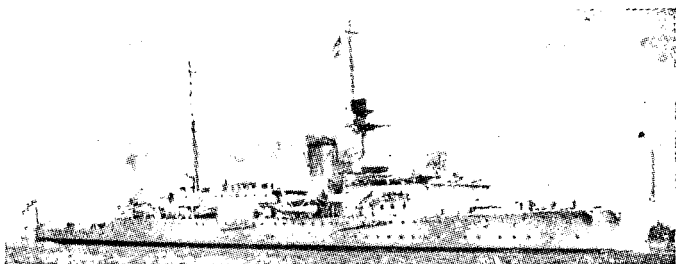
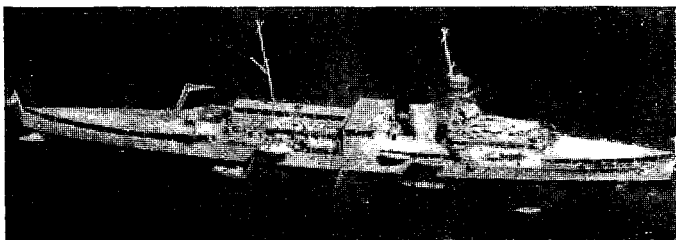

VINDICTIVE

Description: Displacement: 9,100 tons.
Length: 605 feet (over-all).
Beam: 58 feet.
Draft: 20½ feet (maximum).
Speed: 23 knots.

Guns: 2—4.7-inch.
4—3-pounder.
1—2-pounder pompom.

Note: Normal complement of cadets is 200.

BRITISH NAVY

Training Ship

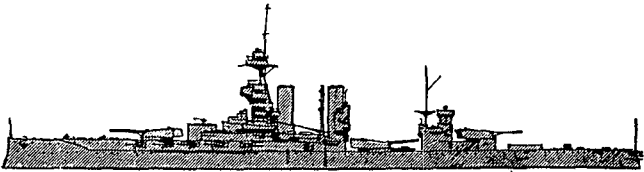
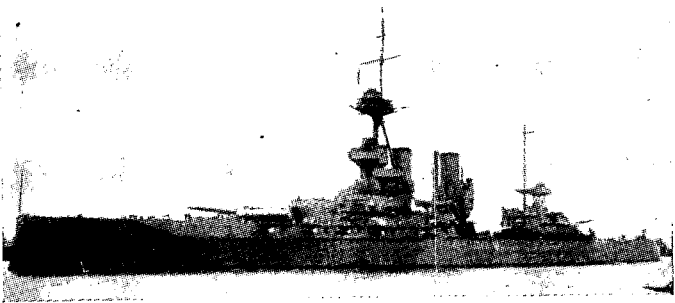

IRON DUKE

Description: Displacement: 21,250 tons.
Length: 580 feet (between perpendiculars).
Beam: 90 feet.
Draft: 26 feet.
Speed: 18 knots.

Guns: 6—13.5-inch.
12—6-inch.

(Others being mounted for trial purposes.)

Note: Complement 589 (exclusive of boys under training)

Monitors
Erebus Class

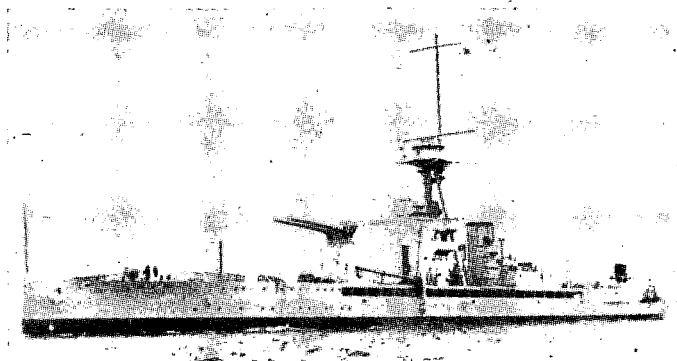

Erebus Class

EREBUS
TERROR

Description: Displacement: 7,200 tons.
Length: 405 feet (over-all).
Beam: 88 feet.
Draft: 11 feet (mean).
Speed: 12 knots.

Guns: 2—15-inch.
8—4-inch in TERROR.
2—3-inch AA.
10 smaller (12 in EREBUS).

BRITISH NAVY

Monitors

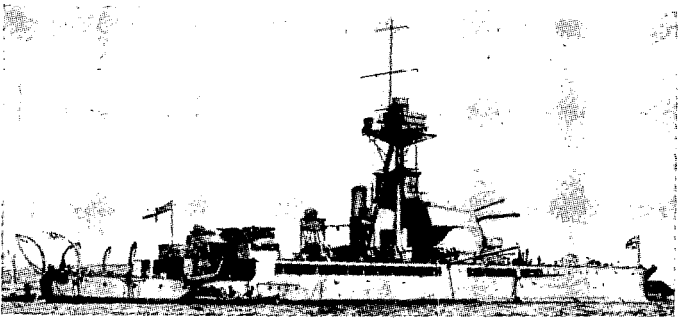

MARSHAL SOULT

Description: Displacement: 6,400 tons.
Length: $355\frac{2}{3}$ feet (over-all).
Beam: $90\frac{1}{4}$ feet.
Draft: $10\frac{1}{2}$ feet.
Speed: 6.7 knots.
Guns: 2—15-inch.

Training Aircraft
Carriers

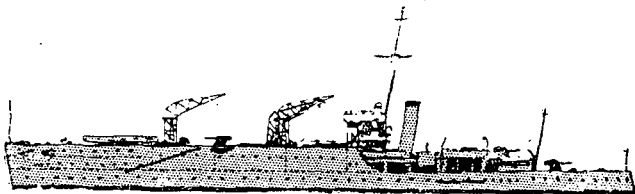
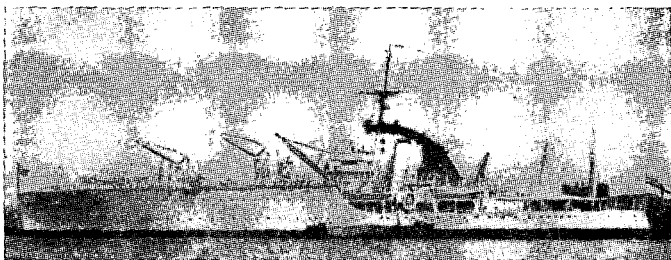

ALBATROSS

Description: Displacement: 4,800 tons.

Length: 443 $\frac{3}{4}$ feet (over-all).

Beam: 58 feet.

Draft: 13 $\frac{3}{4}$ feet (mean).

Speed: 21 knots.

Guns: 4—4.7-inch AA.

32 smaller.

Aircraft: Space for 9 seaplanes. Catapults: 1.

BRITISH NAVY

Training Aircraft
Carriers

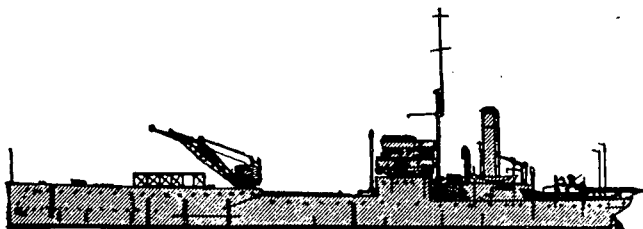
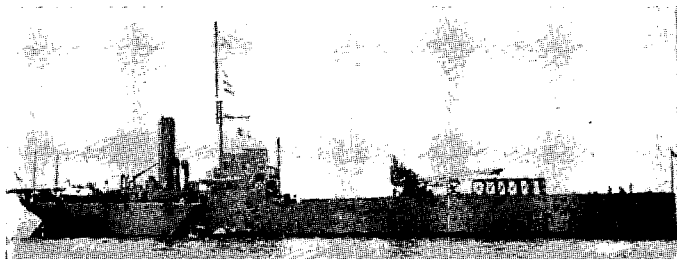

PEGASUS

Description: Displacement: 6,900 tons.

Length: 366 feet (over-all).

Beam: 50 $\frac{5}{6}$ feet.

Draft: 17 $\frac{1}{2}$ feet (mean).

Speed: 11 knots.

Aircraft: Space for 9 seaplanes. Catapults: 1.

IDENTIFICATION OF BRITISH NAVAL SHIPS

Training Aircraft
Carriers

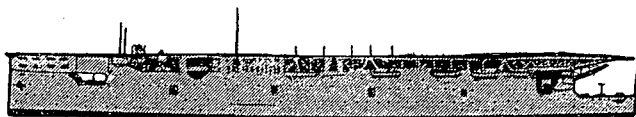
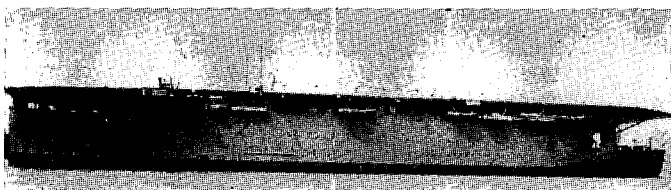

ARGUS

Description: Displacement: 14,000 tons.

Length: 565 feet (over-all).

Beam: 68 feet (excluding bulges).

Draft: 21 feet (mean).

Speed: 20 knots.

Guns: 18 machine guns and Lewis.

Aircraft: 8 target airplanes.

BRITISH NAVY

Submarine Tenders

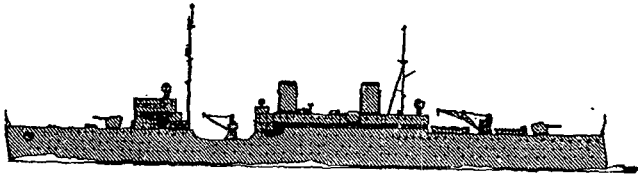
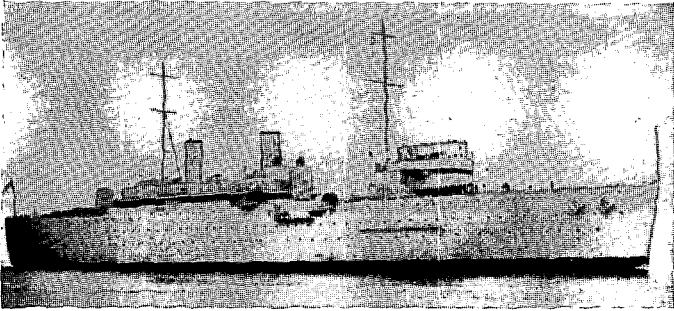

Submarine tender MAIDSTONE

Maidstone Class

MAIDSTONE
FORTH

Description: Displacement: 8,900 tons.
Length: 574 feet (over-all).
Beam: 75 feet.
Draft: 20 feet (mean).
Speed: 17 knots.
Guns: 8—4.5-inch (in pairs).
2 multiple pompoms.
4—3-pounder.
4 smaller.

IDENTIFICATION OF BRITISH NAVAL SHIPS

SECTION III

ROYAL AUSTRALIAN NAVY

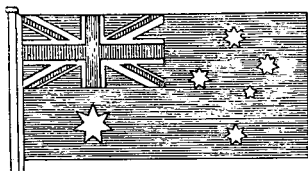

Ensign, Royal Australian Navy.

ROYAL AUSTRALIAN NAVY

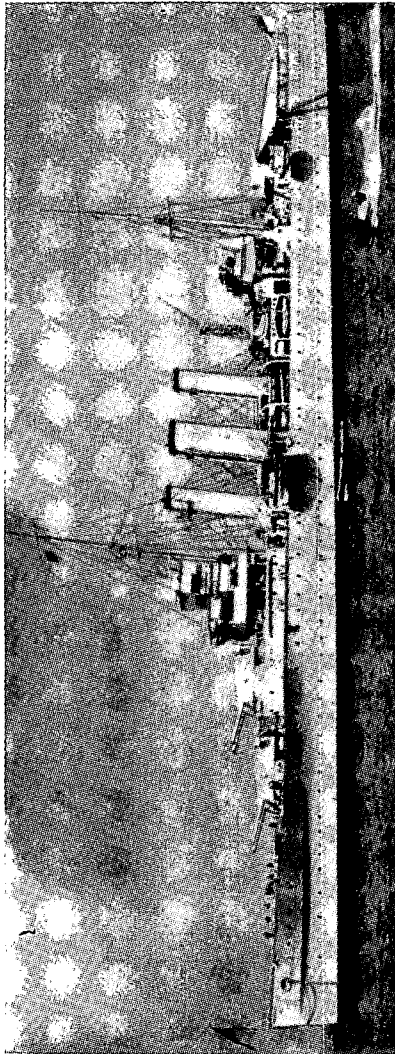

Cruiser AUSTRALIA

Cruisers
Australia Class

Australia Class

AUSTRALIA
CANBERRA

Description: Displacement: 10,000 tons.
Length: 630 feet (over-all).
Beam: 68 $\frac{1}{3}$ feet.
Draft: 16 $\frac{1}{4}$ feet (mean).
Speed: 31.5 knots.

Guns: 8—8-inch.
8—4-inch AA.
4—3-pounder.
4—2-pounder pompoms.
4 machine.
8 Lewis.

Torpedo tubes: 8—21-inch (being removed).
Aircraft: 1 in AUSTRALIA.

ROYAL AUSTRALIAN NAVY

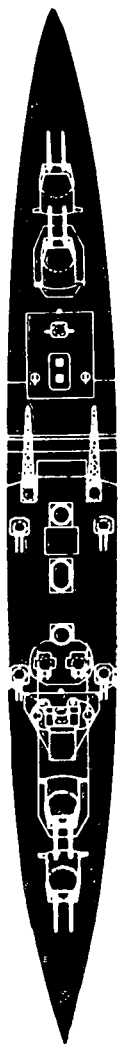
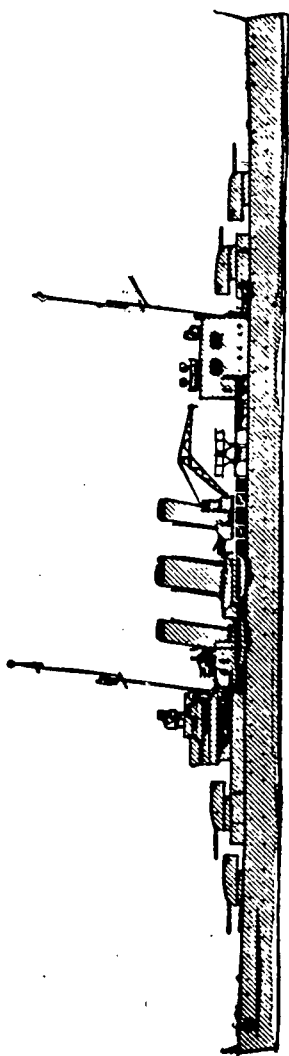

Cruisers AUSTRALIA and CANBERRA

Cruisers
Australia Class

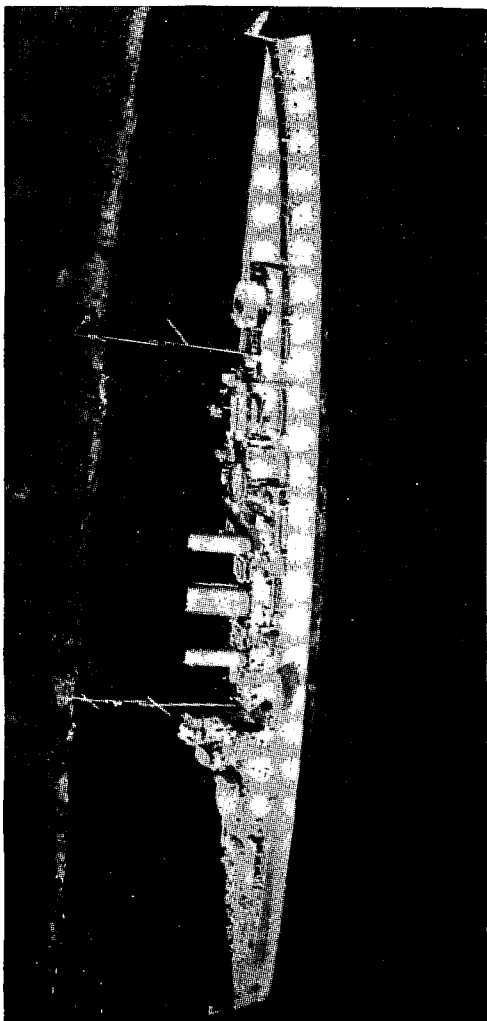

Cruiser AUSTRALIA

ROYAL AUSTRALIAN NAVY

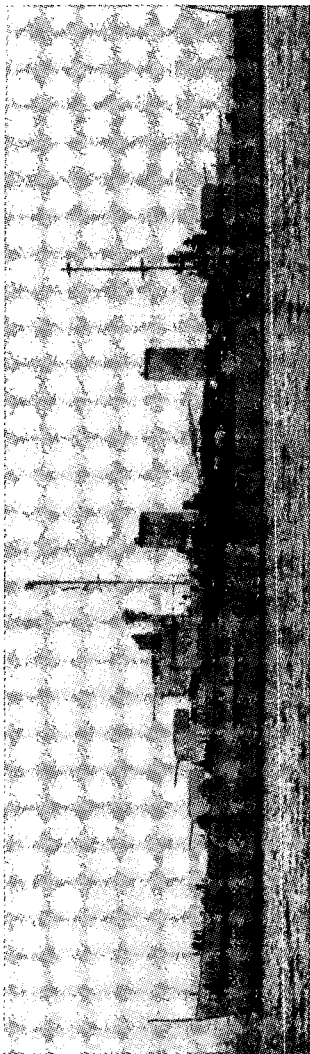

Cruiser SYDNEY.

Cruisers
Perth Class

Perth Class

PERTH (6,980 tons)
 SYDNEY (6,830 tons)
 HOBART (7,105 tons)

Description: Displacement: As above.
 Length: 555 feet (waterline).
 Beam: $56\frac{2}{3}$ feet.
 Draft: $15\frac{2}{3}$ feet (mean).
 Speed: 32.5 knots.

Guns: 8—6-inch.
 8—4-inch AA.
 4—3-pounder.
 10 smaller.

Torpedo tubes: 8—21-inch (quadrupled).
 Aircraft: 1. Catapult: 1.

ROYAL AUSTRALIAN NAVY

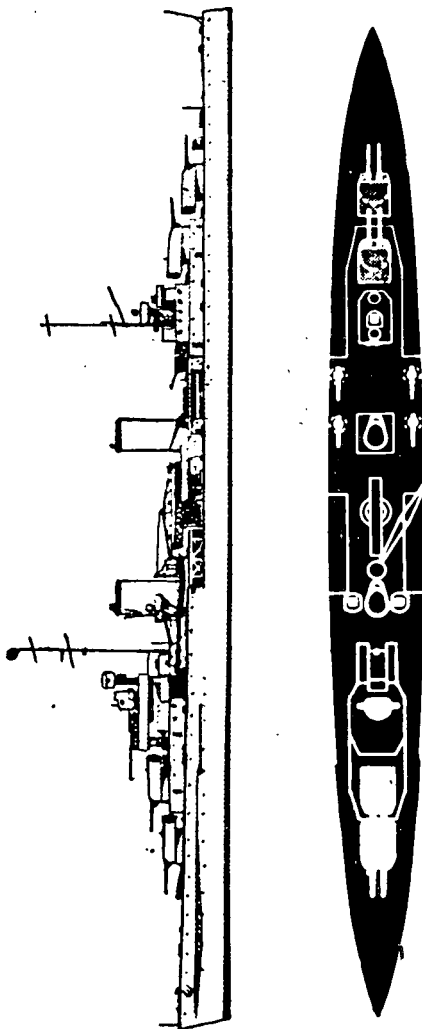

Cruisers, Perth Class.

Cruisers
Perth Class

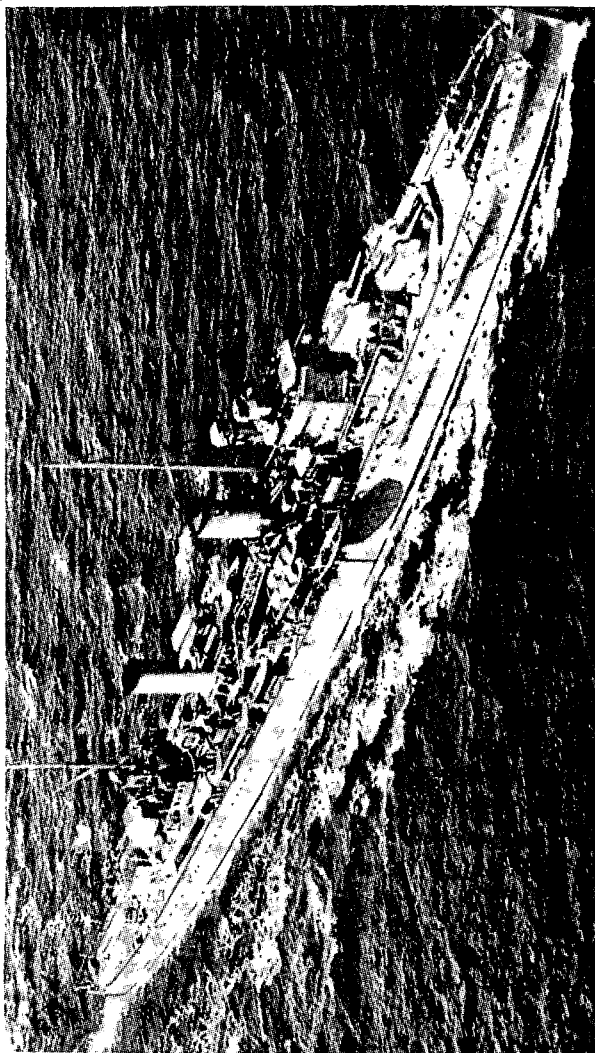

Cruiser SYDNEY.

ROYAL AUSTRALIAN NAVY

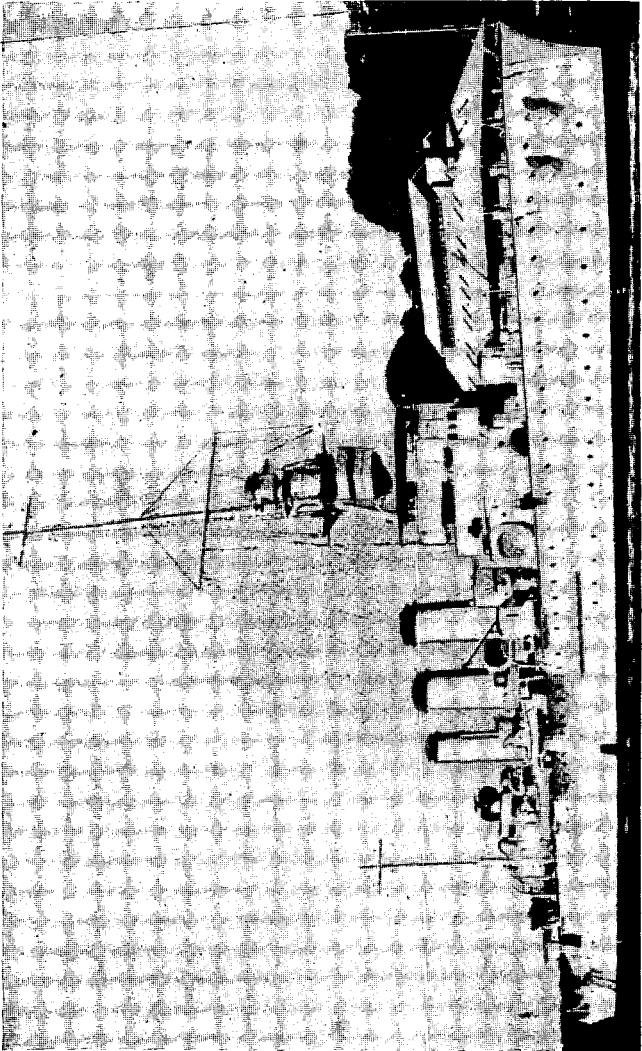

Cruiser ADELAIDE.

Cruiser
ADELAIDE

ADELAIDE

Description: Displacement: 5,100 tons.

Length: $462\frac{2}{3}$ feet (over-all).

Beam: $49\frac{5}{6}$ feet.

Draft: $15\frac{5}{6}$ feet (mean).

Speed: 25.5 knots.

Guns: 8—6-inch.

3—4-inch AA.

4—3-pounder.

12 smaller.

ROYAL AUSTRALIAN NAVY

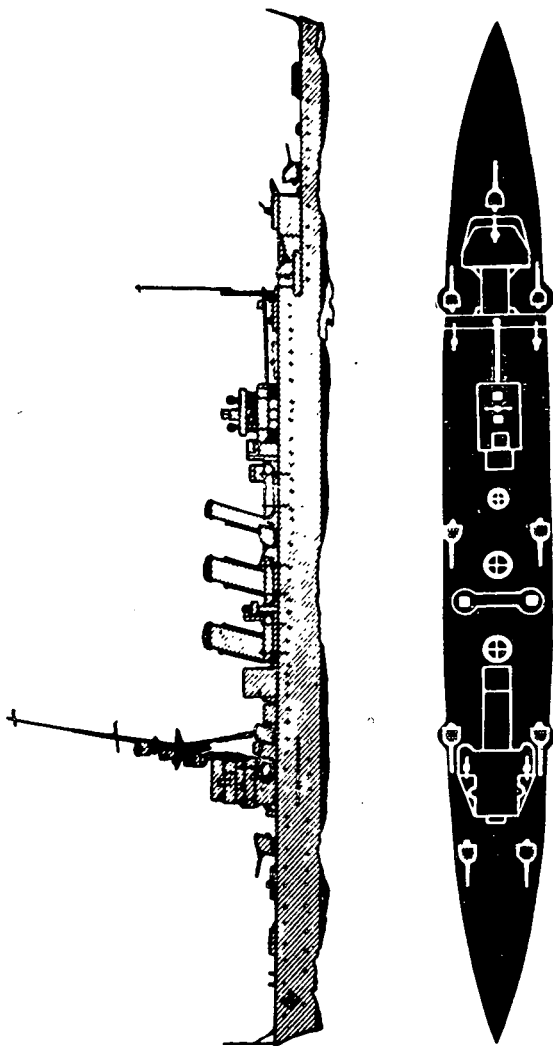

Cruiser ADELAIDE.

IDENTIFICATION OF BRITISH NAVAL SHIPS

Cruiser
ADELAIDE

ROYAL AUSTRALIAN NAVY

Escort Vessels

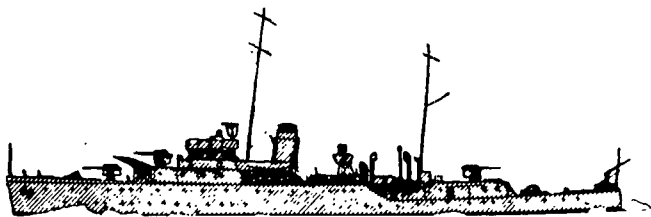
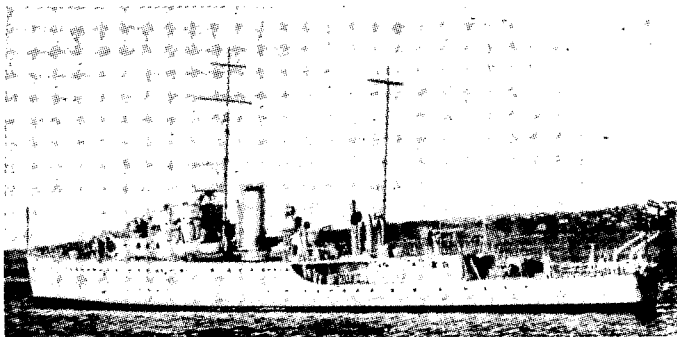

Escort vessel YARRA.

Yarra Class

YARRA

SWAN

Description: Displacement: 1,060 tons.
Length: 266 feet (over-all).
Beam: 36 feet.
Draft: 7½ feet (mean).
Speed: 16.5 knots.

Guns: 3—4-inch AA.
4—3-pounder.
6 machine guns.

IDENTIFICATION OF BRITISH NAVAL SHIPS

Destroyers
"W" and "V" Types

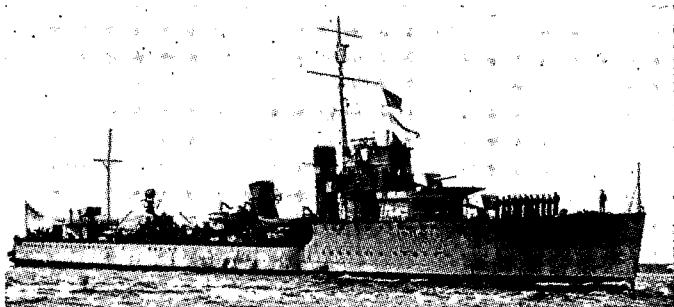

Destroyer VAMPIRE.

"W" and "V" Types

WATERHEN (1,100 tons)

VOYAGER (1,100 tons)

VENDETTA (1,090 tons)

VAMPIRE (1,090 tons)

Description: Displacement: As above.
Length: 312 feet (over-all).
Beam: 29½ feet.
Draft: 10⅝ feet (mean).
Speed: 34 knots.

Guns: 4—4-inch.

5 smaller.

Torpedo tubes: 6—21-inch.

MILITARY INTELLIGENCE

ROYAL AUSTRALIAN NAVY

Destroyers
Arunta Class

(Will resemble Tribal Class of the British Royal Navy.)

ARUNTA

WARRAMUNGA

(Another—name not given)

Description: Displacement: 1,870 tons.

Length: 355½ feet.

Beam: 36½ feet.

Draft: 9 feet.

Speed: 36½ knots.

Guns: 8—4.7-inch.

7 smaller.

Torpedo tubes: 4—21-inch.

IDENTIFICATION OF BRITISH NAVAL SHIPS

ROYAL AUSTRALIAN NAVY

Destroyer
STUART

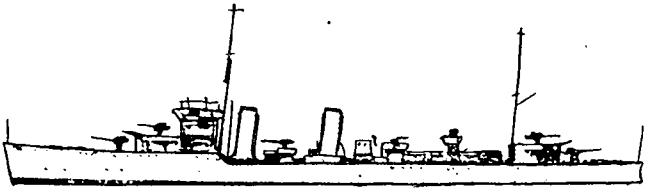
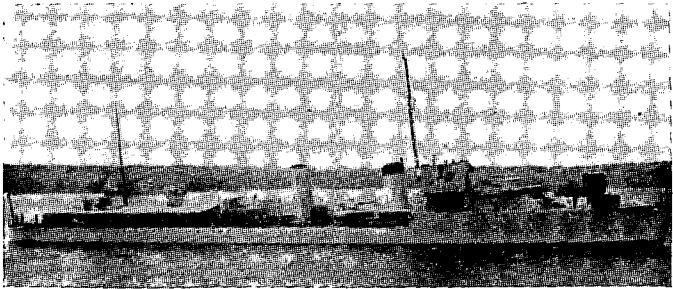

Destroyer STUART.

STUART

Description: Displacement: 1,530 tons.
Length: 332½ feet (over-all).
Beam: 31¾ feet.
Draft: 12¼ feet.
Speed: 36.5 knots.
Guns: 5—4.7-inch.
1—3-inch AA.
7 smaller.
Torpedo tubes: 6—21-inch.

MILITARY INTELLIGENCE

SECTION IV

ROYAL INDIAN NAVY

IDENTIFICATION OF BRITISH NAVAL SHIPS

Escort Vessel
CORNWALLIS

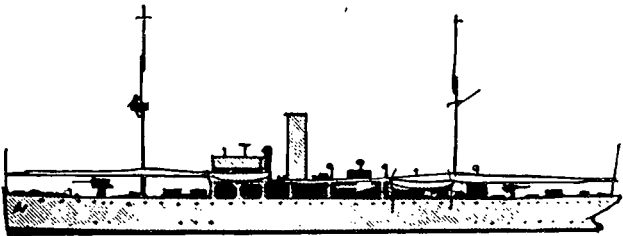
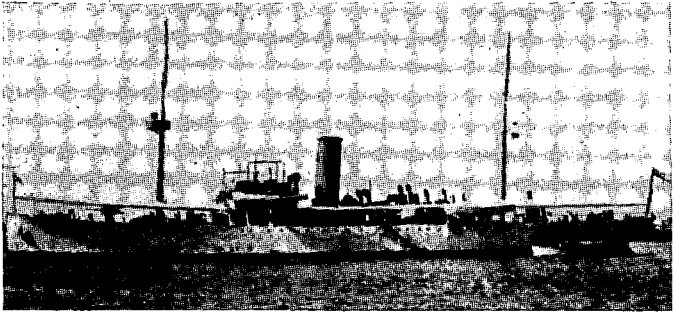

Escort vessel CORNWALLIS.

CORNWALLIS

Description: Displacement: 1,383 tons.

Length: 277 $\frac{3}{4}$ feet (over-all).

Beam: 35 feet.

Draft: 14 $\frac{1}{3}$ feet.

Speed: 16.5 knots.

Guns: 3—4-inch.

4—3-pounder.

12 smaller.

ROYAL INDIAN NAVY

Escort Vessels
Indus Class

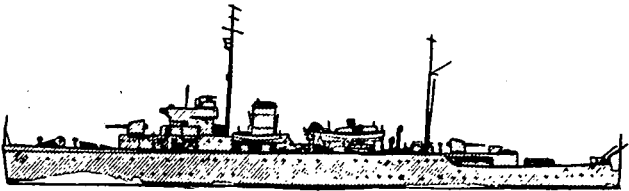
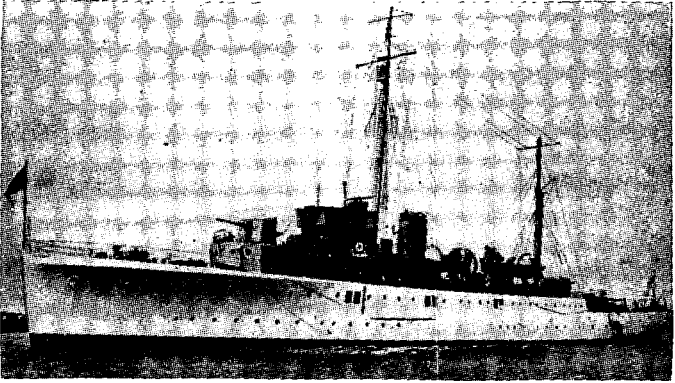

Escort vessel INDUS.

INDUS
HINDUSTAN

Description: Displacement: 1,190 tons.
Length: 296½ feet (over-all).
Beam: 35½ feet.
Draft: 8¾ feet (mean).
Speed: 16.5 knots.
Guns: 2—4.7-inch (4-inch in HINDUSTAN).
4—3-pounder.
11 smaller (10 smaller in HINDUSTAN).

Escort Vessel
LAWRENCE

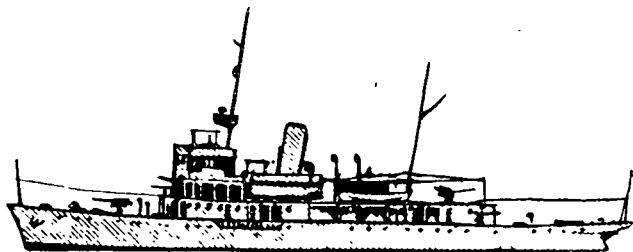
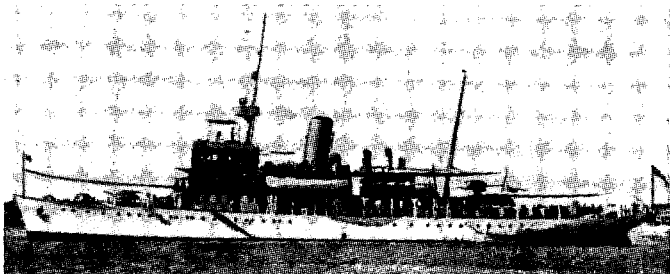

Escort vessel LAWRENCE.

LAWRENCE

Description: Displacement: 1,210 tons.
Length: 241½ feet (over-all).
Beam: 34 feet.
Draft: 12 feet (maximum).
Speed: 15 knots.

Guns: 2—4-inch.
4—3-pounder.
12 smaller.

ROYAL INDIAN NAVY

Escort Vessel
CLIVE

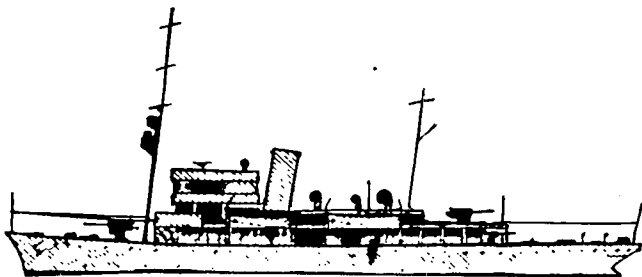
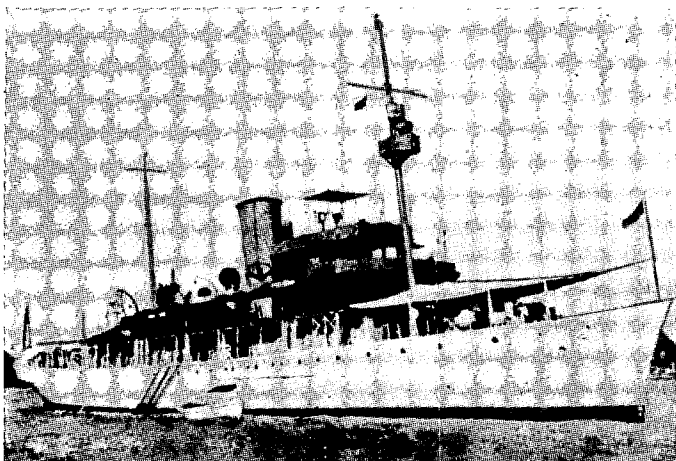

Escort vessel CLIVE.

CLIVE

Description: Displacement: 1,748 tons.
Length: 262½ feet (over-all).
Beam: 38½ feet.
Draft: 14 feet.
Speed: 14.5 knots.
Guns: 2—4-inch.
4—3-pounder.
12 smaller.

IDENTIFICATION OF BRITISH NAVAL SHIPS

SECTION V

ROYAL CANADIAN NAVY

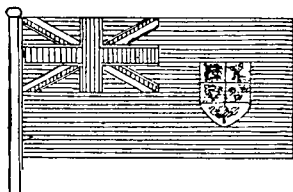

Ensign, Royal Canadian Navy.

ROYAL CANADIAN NAVY

Destroyer
ASSINIBOINE

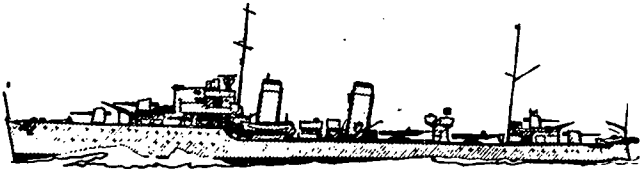
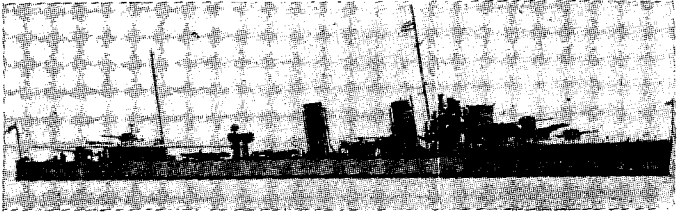

Destroyer ASSINIBOINE.

ASSINIBOINE

Description: Displacement: 1,390 tons.
Length: 326 feet (waterline).
Beam: 33 feet.
Draft: $8\frac{2}{3}$ feet (mean).
Speed: 35.75 knots.
Guns: 4—4.7-inch.
6 smaller.
Torpedo tubes: 8—21-inch.

IDENTIFICATION OF BRITISH NAVAL SHIPS

Destroyers
Ottawa Class

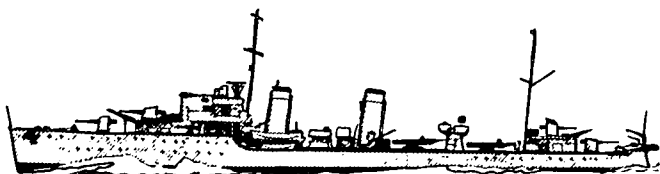
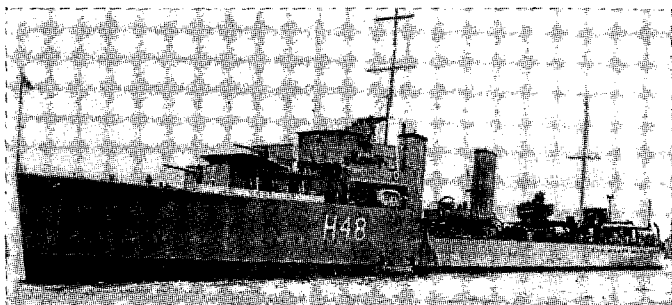

Appearance as FRASER (sunk June 1940).

Ottawa Class.

LAURENT

OTTAWA

RESTIGOUCHE

Description: Displacement: 1,375 tons.

Length: 326 feet (waterline).

Beam: 33 feet.

Draft: 8½ feet (mean).

Speed: 36 knots.

Guns: 4—4.7-inch.

7 smaller.

Torpedo tubes: 8—21-inch (quadrupled).

Note: Plan same as British Defender Class.

ROYAL CANADIAN NAVY

Destroyers
Skeena Class

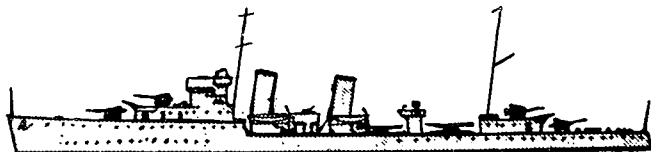

Destroyer SAGUENAY.
Skeena Class

SAGUENAY
SKEENA

Description: Displacement: 1,337 tons.
Length: 321 $\frac{1}{6}$ feet (over-all).
Beam: 32 $\frac{2}{3}$ feet.
Draft: 10 $\frac{1}{2}$ feet (mean).
Speed: 35 knots.

Guns: 4—4.7-inch.
2—2-pounder pompoms.
5 machine guns.

Torpedo tubes: 8—21-inch (quadrupled).

IDENTIFICATION OF BRITISH NAVAL SHIPS

Destroyers
St. Croix Class



"Flush Deck" Type.

St. Croix Class

(Acquired from United States Navy in September 1940, of the
"Flush Deck" Type.)

ST. CROIX

ST. FRANCIS

Description: Displacement: 1,190 tons.
Length: 311 feet (waterline).
Beam: $30\frac{2}{3}$ feet.
Draft: $9\frac{1}{4}$ feet (mean).
Speed: 35 knots.

Guns:

Torpedo tubes:

MILITARY INTELLIGENCE

ROYAL CANADIAN NAVY

Destroyers
Annapolis Class

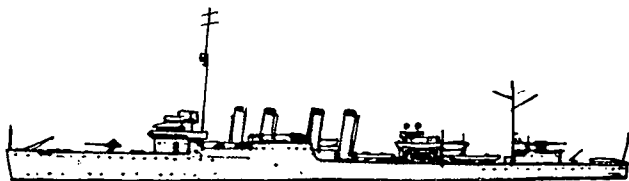

"Flush Deck" Type

Annapolis Class

ANNAPOLIS
COLUMBIA

NIAGARA
ST. CLAIR

Description: Displacement: 1,060 tons.
Length: 309 feet (waterline).
Beam: 30½ feet.
Draft: 8½ feet (mean).
Speed: 35 knots.

Guns:

Torpedo tubes:

Note: Acquired from United States Navy in September 1940; of the "Flush Deck" Type.

IDENTIFICATION OF BRITISH NAVAL SHIPS

SECTION VI

NEW ZEALAND NAVY

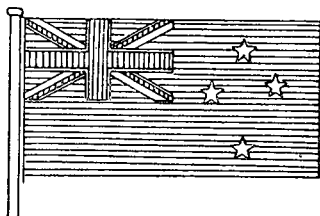

Ensign, New Zealand Navy

NEW ZEALAND NAVY

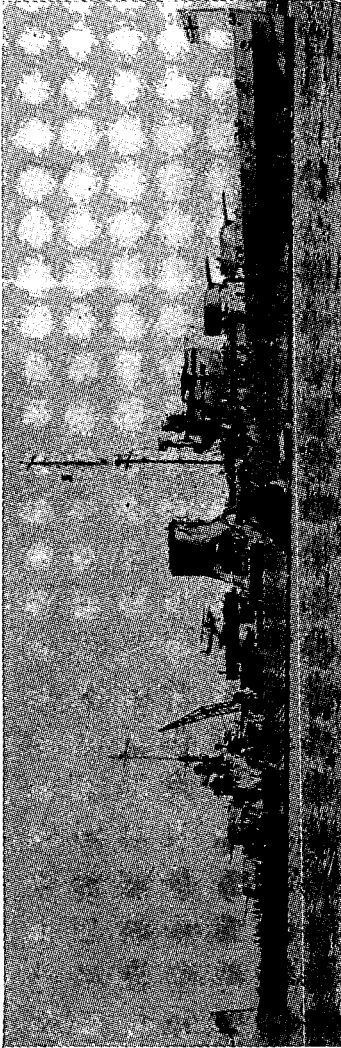

Cruiser ACHILLES.

Achilles Class

(Also listed under British Navy)

ACHILLES (7,030 tons)

LEANDER (7,270 tons)

Description: Displacement: As above.

Length: 554½ feet (over-all).

Beam: 55⅔ feet.

Draft: 15½ feet (mean).

Speed: 32.5 knots.

Guns: 8—6-inch.

8—4-inch AA. (4 in ACHILLES).

4—3-pounder.

10 smaller.

Torpedo tubes: 8—21-inch (quadrupled).

Aircraft: 1.

Catapults: 1

Note: The ACHILLES and LEANDER were transferred from the British Royal Navy. (See p. 95.)

NEW ZEALAND NAVY

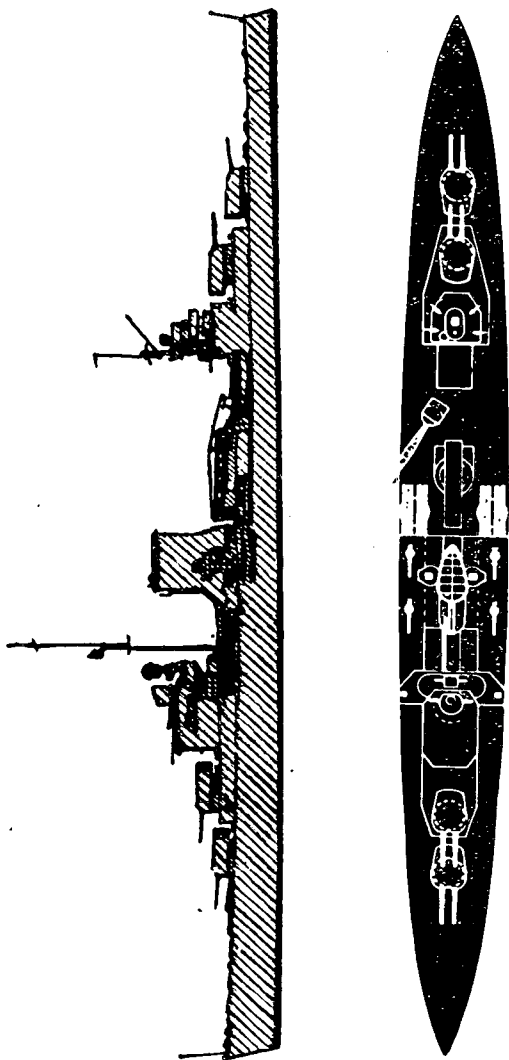

Leander Class.

(Crane is actually mounted on center line and AA guns are paired.)

IDENTIFICATION OF BRITISH NAVAL SHIPS

Cruisers
Achilles Class

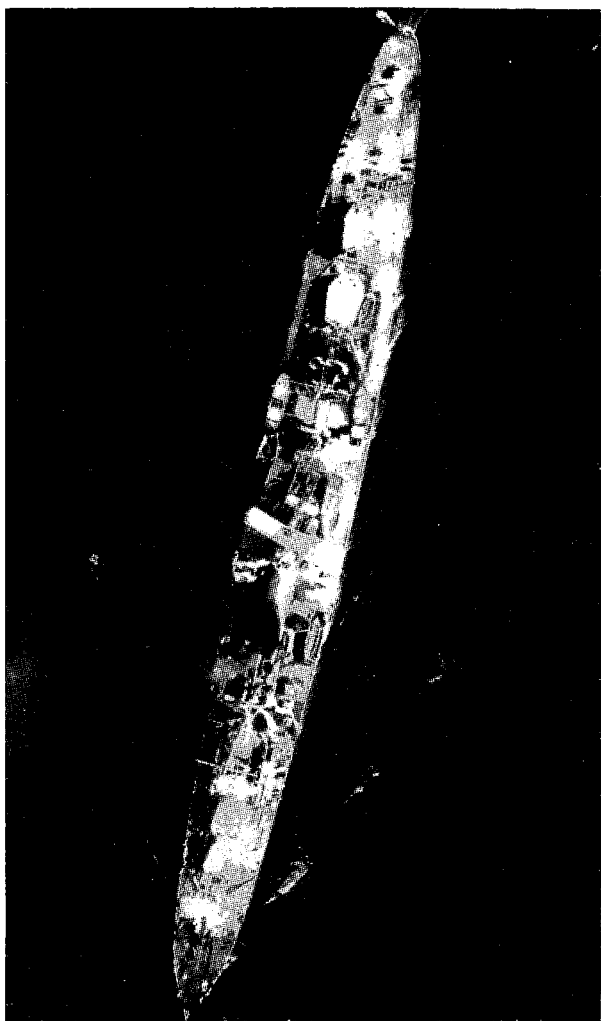

Cruiser LEANDER.

INDEX TO SHIPS

	Page		Page
Abdiel	129	Bradford	173
Aberdare	203	Bramble	202
Aberdeen	194	Bridgewater	196
Abingdon	203	Bridlington	201
Achates	149	Bridport	201
Achilles	95, 243	Brighton	173
Active	149	Brilliant	149
Adelaide	223	Britomart	202
Adventure	127	Broadwater	173
Ajax	95	Broadway	173
Albatross	209	Broke	159
Albury	203	Bulldog	149
Alesford	203	Burnham	173
Amazon	153	Burwell	173
Ambuscade	153	Buxton	173
Annapolis	240		
Anson	15	Cachalot	180
Antelope	149	Cairo	123
Anthony	149	Calcutta	123
Arethusa	91	Caldwell	173
Argus	211	Caledon	115
Ark Royal	43	Cameron	173
Arrow	149	Campbell	161
Arunta	228	Campbeltown	173
Ashanti	135	Canberra	215
Assiniboine	236	Capetown	111
Atherstone	174	Caradoc	115
Auckland	192	Cardiff	111
Aurora	91	Carlisle	123
Australia	215	Castleton	173
		Cattistock	174
Bagshot	203	Ceres	111
Bangor	201	Ceylon	75
Barham	27	Charlestown	173
Bath	173	Charybdis	79
Beagle	149	Chelsea	173
Beaumaris	201	Chesterfield	173
Bedouin	135	Churchill	173
Belfast	83	Clare	173
Belmont	173	Cleopatra	79
Berkeley	174	Cleveland	174
Berwick	71	Clive	234
Beverley	173	Clyde	181
Bideford	196	Codrington	151
Birmingham	87	Colombo	111
Blackpool	201	Columbia	240
Black Swan	191	Cornwall	71
Blyth	201	Cornwallis	231
Boadicea	149	Cossack	135
Bonaventure	79	Cotswold	174
Boreas	149	Cottesmore	174
Boston	201	Coventry	119

INDEX TO SHIPS

	Page		Page
Cromarty	201	Formidable	39
Cumberland	71	Foresight	145
Curacoa	123	Forester	145
Dainty	147	Forth	212
Danae	107	Fortune	145
Dauntless	107	Fowey	196
Decoy	147	Foxglove	197
Defender	147	Foxhound	145
Delhi	107	Frobisher	103
Deptford	195	Furious	47
Derby	203	Fury	145
Despatch	107	Galatea	91
Devonshire	67	Gallant	139
Diamond	147	Gambia	75
Dido	79	Garland	139
Diomedea	107	Garth	174
Dorsetshire	63	Georgetown	173
Douglas	161	Glasgow	87
Dragon	107	Gleaner	202
Duke of York	15	Gloucester	87
Dunbar	201	Gossamer	202
Duncan	143	Greyhound	139
Dunedin	107	Griffin	139
Durban	107	Grimsby	195
Eagle	51	Guillemot	198
Echo	145	H28, H31, H32, H33, H34, H43, H44, H50	189
Eclipse	145	Halcyon	202
Edinburgh	83	Hambledon	174
Eglinton	174	Hamilton	173
Egret	192	Harrier	202
Electra	145	Harrow	203
Elgin	203	Hastings	196
Emerald	99	Hasty	139
Enchantress	193	Havock	139
Encounter	145	Hawkins	103
Enterprise	99	Hazard	202
Erebus	207	Hebe	202
Erne	191	Hereward	139
Escapade	145	Hermes	55
Eskimo	135	Hermione	79
Euryalus	79	Hero	139
Exeter	59	Hindustan	232
Exmoor	174	Hobart	219
Express	145	Holderness	174
Falmouth	196	Hotspur	139
Fame	145	Howe	15
Fareham	203	Huntly	203
Faulknor	143	Hussar	202
Fearless	145	Ibis	191
Fermoy	203	Icarus	137
Fernie	174	Ilex	137
Fiji	75	Ilfracombe	201
Firedrake	145	Illustrious	39
Flamingo	191	Imperial	137
Fleetwood	194		

INDEX TO SHIPS

	Page		Page
Implacable.....	39	Lowestoft.....	195
Impulsive.....	137	Loyal.....	131
Indefatigable.....	39	Ludlow.....	173
Indomitable.....	39	Lupin.....	197
Indus.....	232	Lydd.....	203
Inglefield.....	141		
Intrepid.....	137	Mackay.....	161
Iron Duke.....	206	Maidstone.....	212
Isis.....	137	Malaya.....	27
		Malcolm.....	161
Jackal.....	133	Mallard.....	199
Jaguar.....	133	Manchester.....	87
Jamaica.....	75	Mansfield.....	173
Janus.....	133	Manxman.....	129
Jason.....	202	Maori.....	135
Javelin.....	133	Marksman.....	131
Jersey.....	133	Marne.....	131
Jervis.....	133	Marshal Soult.....	208
Juno.....	133	Martin.....	131
Jupiter.....	133	M. A. S. B. 1 to 6.....	178
		Mashona.....	135
Kandahar.....	133	Matabele.....	135
Kashmir.....	133	Matchless.....	131
Kelly.....	133	Mauritius.....	75
Kelvin.....	133	Mendip.....	174
Kent.....	71	Meteor.....	131
Kenya.....	75	Meynell.....	174
Keppel.....	159	Milford.....	196
Khartoum.....	133	Milne.....	131
Kimberley.....	133	M. M. S. 1, 2.....	204
Kingfisher.....	199	Mohawk.....	135
King George V.....	15	Montgomery.....	173
Kingston.....	133	Montrose.....	161
Kipling.....	133	Musketeer.....	131
Kittiwake.....	199	Myrmidon.....	131
L23, L26, L27.....	185	Naiad.....	79
Laforey.....	131	Napier.....	133
Lancaster.....	173	Nelson.....	19
Lance.....	131	Neptune.....	95
Larne.....	131	Nerissa.....	133
Latonia.....	129	Nestor.....	133
Laurent.....	237	Newark.....	173
Lawrence.....	233	Newcastle.....	87
Leamington.....	173	Newmarket.....	173
Leander.....	95, 243	Newport.....	173
Leda.....	202	Niagara.....	240
Leeds.....	173	Niger.....	202
Legion.....	131	Nigeria.....	75
Leith.....	195	Nizam.....	133
Lewes.....	173	Noble.....	133
Lightning.....	131	Nonparell.....	133
Lincoln.....	173	Norfolk.....	63
Lively.....	131	Norman.....	133
Liverpool.....	87	Norseman.....	133
Llandudno.....	201	Nubian.....	135
London.....	67	No. 1 to 12.....	177
Londonderry.....	195	No. 14 to 19.....	177
Lookout.....	131	No. 22, 24, 25.....	175

INDEX TO SHIPS

	Page		Page
No. 100.....	177	Sabre.....	171
No. 101, 102, 103.....	176	Saguenay.....	238
Oberon.....	186	St. Albans.....	173
Olympus.....	184	St. Clair.....	240
Orion.....	95	St. Croix.....	239
Osiris.....	184	St. Francis.....	239
Ottawa.....	237	St. Mary's.....	173
Otus.....	184	Saladin.....	171
Otway.....	186	Salamander.....	202
Pandora.....	183	Salisbury.....	173
Pangbourne.....	203	Saltash.....	203
Parthian.....	183	Saltburn.....	203
P. C. 74.....	200	Sandwich.....	196
Pegasus.....	210	Sardonyx.....	171
Pelican.....	192	Scimitar.....	171
Penelope.....	91	Scout.....	171
Perseus.....	183	Scylla.....	79
Perth.....	219	Seagull.....	202
Peterhead.....	201	Sealion.....	187
Phoebe.....	79	Seawolf.....	187
Pintail.....	198	Selkirk.....	203
Polruan.....	201	Severn.....	181
Porpoise.....	180	Sharpshooter.....	202
Prince of Wales.....	15	Shearwater.....	198
Proteus.....	183	Sheffield.....	87
Puffin.....	199	Sheldrake.....	199
Punjabi.....	135	Sherwood.....	173
Pytchley.....	174	Shikari.....	171
Quantock.....	174	Shoreham.....	196
Queen Elizabeth.....	23	Shropshire.....	67
Quorn.....	174	Sidmouth.....	201
Ramillies.....	31	Sikh.....	135
Ramsey.....	173	Sirius.....	79
Reading.....	173	Skate.....	169
Regent.....	182	Skeena.....	238
Renown.....	35	Snapper.....	187
Repulse.....	35	Somali.....	135
Resolution.....	31	Southampton.....	87
Restigouche.....	237	Southdown.....	174
Revenge.....	31	Speedwell.....	202
Rhyl.....	201	Speedy.....	202
Richmond.....	173	Stanley.....	173
Ripley.....	173	Stoke.....	203
Rochester.....	196	Stork.....	193
Rockingham.....	173	Stornoway.....	201
Rodney.....	19	Stronghold.....	171
Romney.....	201	Stuart.....	229
Rorqual.....	180	Suffolk.....	71
Rosemary.....	197	Sunfish.....	187
Ross.....	203	Sussex.....	67
Rothesay.....	201	Sutton.....	203
Rover.....	182	Swan.....	226
Roxborough.....	173	Sydney.....	219
Royal Sovereign.....	31	Taku.....	179
Rye.....	201	Talisman.....	179
		Tartar.....	135
		Tedworth.....	203
		Tenby.....	201

INDEX TO SHIPS

	Page		Page
Tenedos	171	Vivacious	165
Terror	207	Vivien	190
Tetrarch	179	Volunteer	155
Thanet	171	Vortigern	165
Thracian	171	Voyager	227
Thunderbolt	179	Walker	163
Tigris	179	Wallace	190
Torbay	179	Walpole	163
Tribune	179	Wanderer	155
Trinidad	75	Warramunga	228
Trinidad	75	Warspite	23
Triton	179	Warwick	163
Triumph	179	Watchman	163
Truant	179	Waterhen	227
Tuna	179	Wellington	195
Tynedale	174	Wells	173
Uganda	75	Welshman	129
Unity	188	Westcott	163
Ursula	188	Westminster	190
Valiant	28	Weston	196
Valorous	190	Whaddon	174
Vampire	227	Whitehall	155
Vanessa	165	Whitshed	155
Vanity	165	Widgeon	199
Vanoc	165	Widnes	203
Vanquisher	165	Wild Swan	155
Vansittart	155	Winchelsea	163
Vega	190	Winchester	190
Velox	165	Windsor	190
Vendetta	227	Wishart	157
Venomous	155	Witch	157
Verdun	165	Witherington	155
Verity	155	Wivern	155
Versatile	165	Wolfhound	163
Vesper	165	Wolsey	190
Veteran	155	Wolverine	155
Viceroy	167	Woolston	190
Victorious	39	Worcester	155
Vidette	165	Wrestler	190
Vimiera	190	Wryneck	190
Vimy	165	Yarra	226
Vindictive	205	Zulu	135
Viscount	167		