

JAC
DEPARTMENT OF THE ARMY
FIELD **MHI** MANUAL
Copy 3
DEPARTMENT OF THE AIR
FORCE MANUAL

FM 23-35
AFM 50-17

PISTOLS AND REVOLVERS



PAUL J. ROBERTS
5915 Monte Verde Dr.
Santa Rosa, Calif.
95405



DEPARTMENTS OF THE ARMY AND THE AIR FORCE

JULY 1960

Army Field Manual No. 23-35 Air Force Manual No. 50-17	}	DEPARTMENTS OF THE ARMY AND THE AIR FORCE WASHINGTON 25, D. C., 1 July 1960
---	---	---

PISTOLS AND REVOLVERS

		Paragraphs	Page
PART ONE.	INTRODUCTION.....	1, 2	3
	TWO. PISTOLS, AUTOMATIC, CALIBER .45, M1911 AND M1911A1.		
CHAPTER 1.	INTRODUCTION.....	3-5	4
	2. MECHANICAL TRAINING		
Section I.	Disassembly and assembly.....	6-19	7
	II. Functioning of the pistol.....	20-32	24
	III. Loading, firing, and unloading.....	33-35	30
	IV. Malfunctions, stoppages, and immediate action.	36-39	32
	V. Care and cleaning.....	40-47	35
	VI. Repair parts and accessories.....	48, 49	39
	VII. Ammunition.....	50-56	40
CHAPTER 3.	MANUAL OF ARMS FOR THE PISTOL....	57-59	44
	4. MARKSMANSHIP TRAINING		
Section I.	General.....	60-62	50
	II. Preparatory marksmanship training.....	63-77	50
	III. Courses fired.....	78-82	73
	IV. Range firing and safety precautions.....	83-89	76
	V. Targets and ranges.....	90, 91	88
CHAPTER 5.	ADVICE TO INSTRUCTORS		
Section I.	General.....	92, 93	92
	II. Mechanical training.....	94-99	93
	III. Manual of arms for the pistol.....	100	95
	IV. Marksmanship.....	101-103	96
	V. Training schedules.....	104-106	98
	VI. Training aids.....	107-109	102
PART THREE.	REVOLVER, COLT, CALIBER .38, 2-INCH BARREL, DETECTIVE SPECIAL.		
CHAPTER 6.	INTRODUCTION.....	110, 111	109
	7. MECHANICAL TRAINING		
Section I.	Disassembly and assembly.....	112	112
	II. Loading, firing, and unloading.....	113-115	112

*This manual supersedes FM 23-35/AFM 50-17, 26 February 1953, including C1, 31 December 1953.

	Paragraphs	Page
Section III. Safety devices and safety tests.....	116, 117	114
IV. Malfunctions, stoppages, and immediate action.....	118-121	114
V. Care and cleaning.....	122-127	116
VI. Repair parts and accessories.....	128	118
VII. Ammunition.....	129-131	118
CHAPTER 8. MANUAL OF ARMS FOR THE REVOLVER.....	132-135	120
9. MARKSMANSHIP TRAINING		
Section I. General.....		122
II. Preparatory marksmanship training.....	136-145	122
III. Courses fired.....	146, 147	133
IV. Range firing and safety precautions.....	148-152	134
V. Targets and ranges.....	153, 154	139
CHAPTER 10. ADVICE TO INSTRUCTORS		
Section I. General.....	155	143
II. Training schedules.....	156, 157	143
APPENDIX. REFERENCES.....		147
INDEX.....		149

PART ONE

INTRODUCTION

1. Purpose and Scope

a. The purpose of this manual is to—

- (1) Teach methods of caring for pistols and revolvers in the field and in garrison.
- (2) Outline principles, methods, and techniques that will insure the effective use of pistols both in training and in combat.
- (3) Promote uniformity in training.
- (4) Provide a handbook for the soldier in learning and teaching the pistol and revolver.

b. This manual is in three parts and explains how to disassemble, assemble, fire, and take care of the Pistols, Automatic, Caliber .45, M1911 and M1911A1, and the Revolver, Colt, Caliber .38, 2-Inch Barrel, Detective Special. It describes the parts and explains how they work. The step-by-step arrangement of the text provides for progressive training, promotes learning, and aids in organizing and presenting instruction.

c. Where training in the pistol and revolver is similar, reference is made to the paragraph pertaining to the pistol that may be used for training in the revolver. Where pertinent, simply substitute the word *revolver* for the word *pistol*.

2. Importance of Pistol Training

The pistol is an individual weapon intended for use in close combat. It is carried by members of weapons crews and used as a side arm in military police duties. The soldier must keep his pistol in good working condition and have the utmost confidence in his marksmanship ability. This ability can be acquired only through study and practical training.

PART TWO
PISTOLS, AUTOMATIC, CALIBER .45, M1911
AND M1911A1

CHAPTER 1
INTRODUCTION

3. General Description

a. Pistol. The Pistols, Automatic, Caliber .45, M1911 and M1911A1, are semiautomatic, recoil operated, magazine fed, hand weapons. The pistol fires one round each time the trigger is squeezed. The energy needed to operate the pistol for each round after the first comes from the recoil of the previous round fired (rearward force of expanding powder gases).

b. Magazine. The magazine holds seven cartridges. The upper cartridge is stripped from the magazine and chambered by the forward movement of the slide. When the last cartridge from the magazine has been fired, the slide remains to the rear.

c. Rate of Fire. The rate of fire is limited only by the soldier's ability to rapidly change magazines, aim, and squeeze the trigger.

4. Differences in Models

The M1911 and M1911A1 pistols are basically alike. The M1911A1 was developed from the M1911, which was modified as follows (figs. 1 and 2):

a. The front sight was widened.

b. The notch in the rear sight was widened to correspond to the front sight.

c. The tang on the grip safety was extended to protect the hand.

d. The mainspring housing was knurled and curved to fit the hand.

e. A clearance cut was made on the receiver for the trigger finger.

f. The face of the trigger was cut back and knurled.

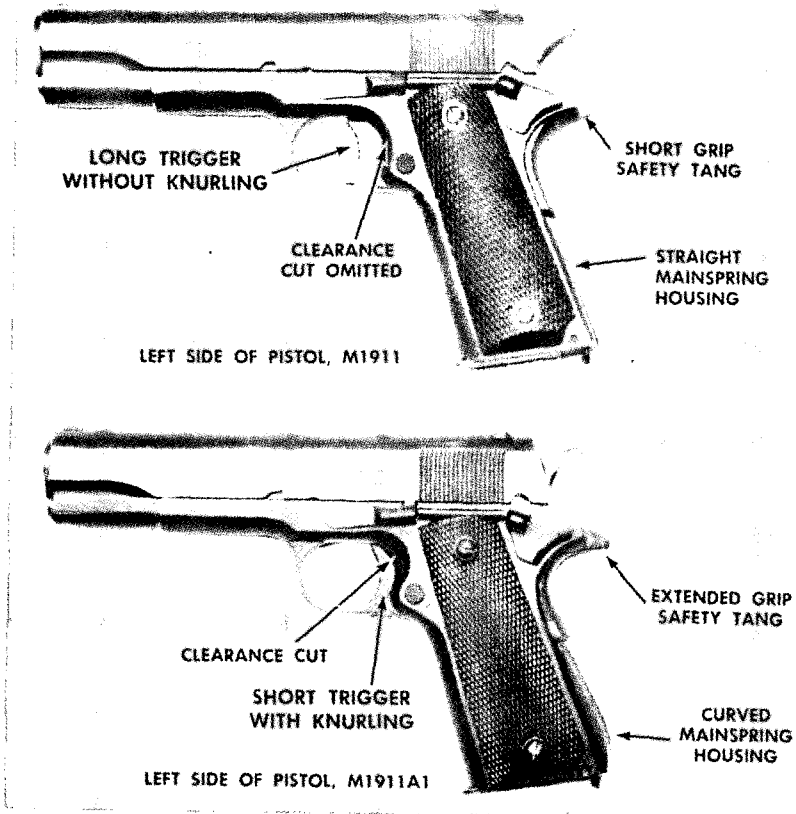

Figure 1. Pistols, Automatic, Caliber .45, M1911 and M1911A1, showing differences between models.

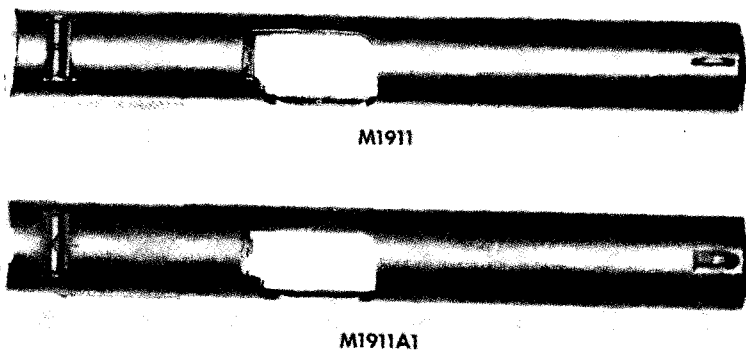

Figure 2. Top view of pistols showing differences in sights between M1911 and M1911A1.

CHAPTER 2

MECHANICAL TRAINING

Section I. DISASSEMBLY AND ASSEMBLY

6. General

To insure that the pistol will function correctly, it is necessary to disassemble it to inspect and clean the parts. This chapter explains general disassembly, detailed disassembly of the three main groups, assembly, functioning, care and cleaning, stoppages, and immediate action. It is a guide for mechanical training and outlines the procedures to be followed.

7. Nomenclature

The names of the parts of the pistol are learned during practice in disassembly and assembly. As each part is removed and replaced, the nomenclature is repeated until known. Generally, the parts are named for their functions. For example, the *trigger guard* guards the trigger, the *extractor* extracts the cartridge case from the chamber, and the *ejector* ejects the cartridge case from the pistol.

8. Guides to Follow in Disassembly and Assembly

These guides should be followed when the pistol is being disassembled and assembled.

a. Follow the step-by-step explanation in disassembling the pistol.

b. If it is necessary to apply force, do it carefully so that none of the parts become damaged.

c. As the weapon is disassembled, lay out the parts in the order of their removal. Disassembly mats (GTA 9-617) are excellent aids during this phase of training. This procedure helps in assembly of the weapon, which is done in the reverse order of disassembly.

9. General Disassembly

General disassembly is the disassembly necessary for normal care and cleaning. General disassembly consists of the removal of the parts shown in figure 10.

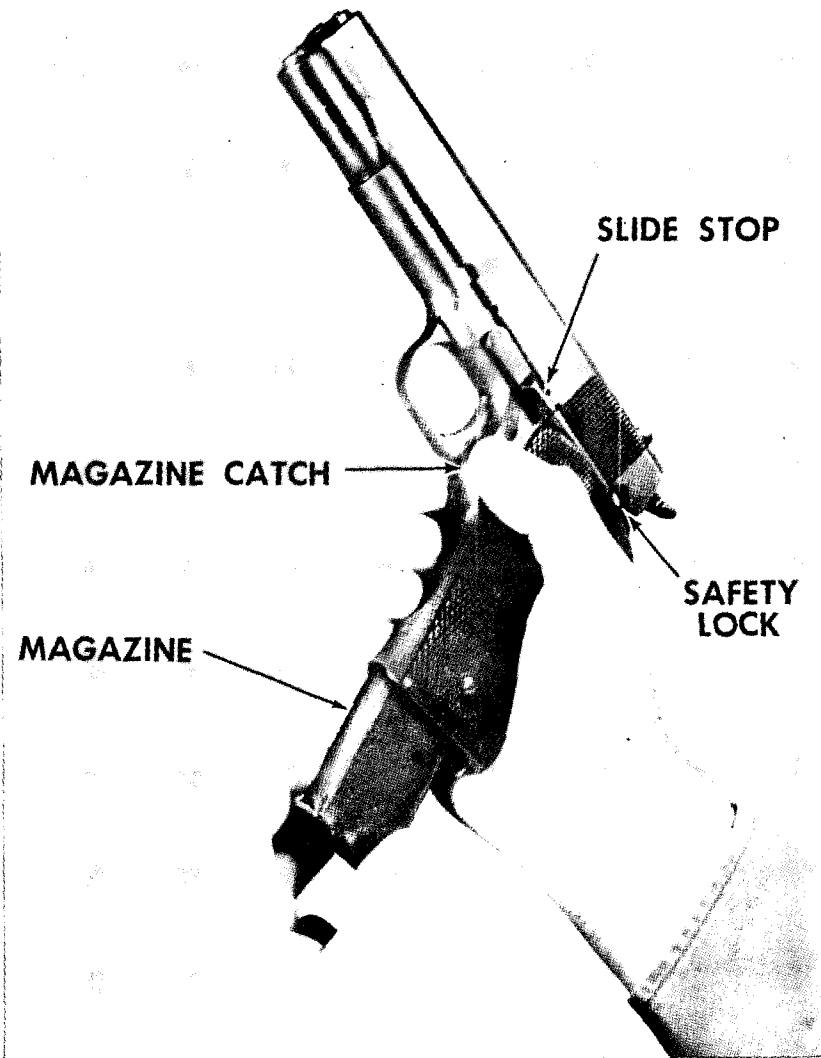

Figure 3. Press the magazine catch and remove the magazine. Pull the slide to the rear and inspect the chamber to see that the weapon is clear. Press down on the slide stop and allow slide to move forward. Press the safety lock upward to the SAFE position.

10. Procedure for General Disassembly

Procedure for general disassembly is shown in figures 3 through 9.

11. Procedure for General Assembly

Replace parts in reverse order of disassembly.

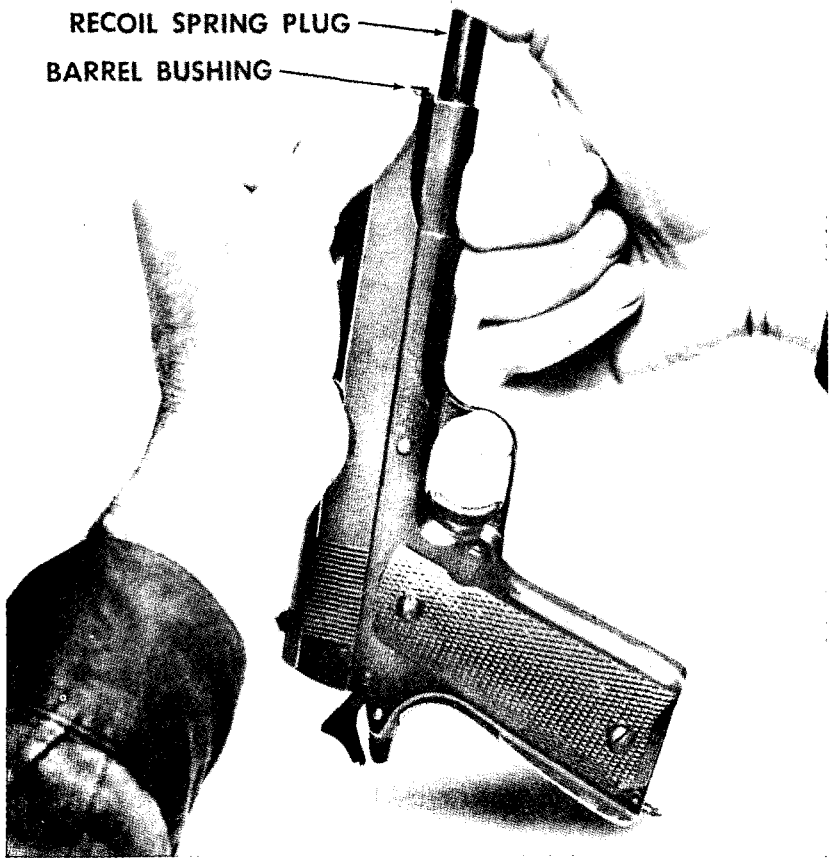

Figure 4. Press down on the recoil spring plug and turn the barrel bushing $\frac{1}{4}$ turn clockwise. Allow the recoil spring to expand slowly, under control, to prevent injury or loss of the part. Turn the recoil spring plug counterclockwise and remove it from the recoil spring.

a. Barrel. Push the barrel link forward on the barrel and replace the barrel, chamber end first, in the slide (fig. 9).

b. Barrel Bushing. Place the barrel bushing on the muzzle end of the barrel, push it into the slide, and turn it clockwise (fig. 8).

c. Recoil Spring and Recoil Spring Guide. Insert the recoil spring guide into the tightest end of the recoil spring. Replace these parts in the slide (fig. 7). Be sure that the concave cut on the recoil spring guide collar is properly seated on the barrel. Push the barrel, recoil spring, and recoil spring guide fully forward in the slide, insuring that the barrel link is positioned

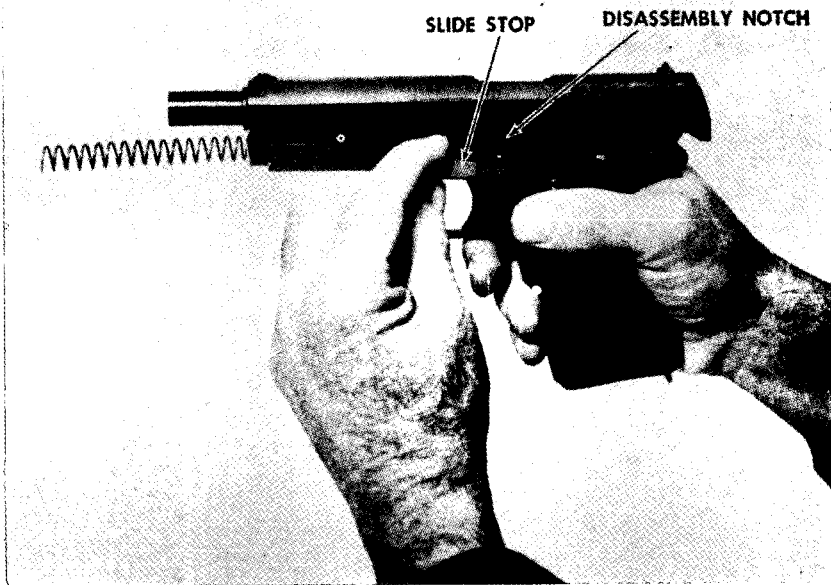

Figure 5. Press the safety lock downward to the FIRE position. Push the slide to the rear until the disassembly notch is aligned with the rear projection on the slide stop. Press the protruding end of the slide stop with the right forefinger and pull out the slide stop.

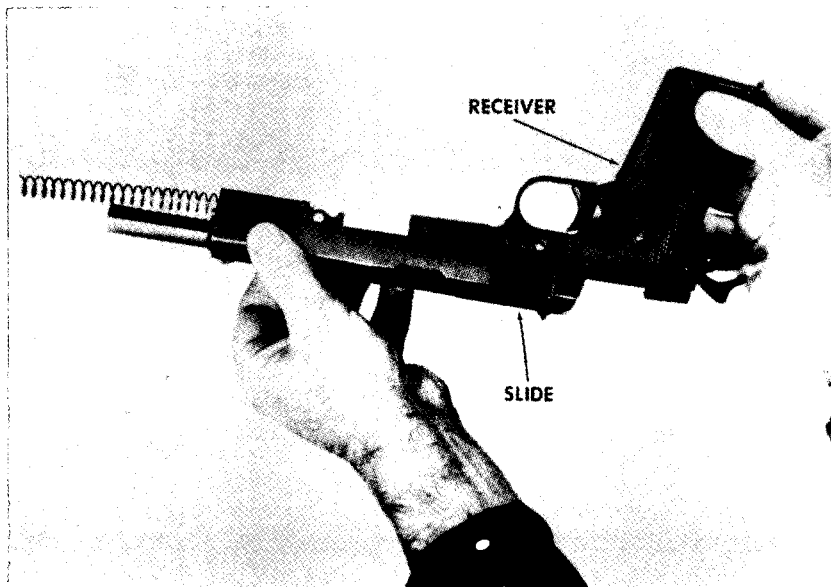

Figure 6. Pull the receiver rearward to separate it from the slide.

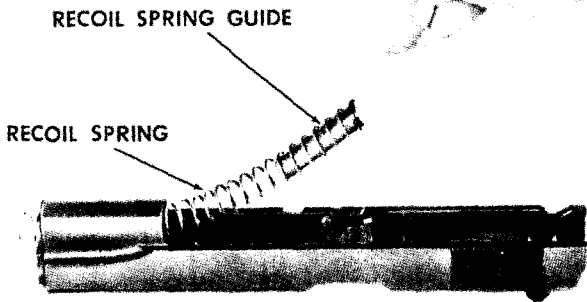

Figure 7. Remove the recoil spring guide and recoil spring. Separate the two parts with a twisting action.

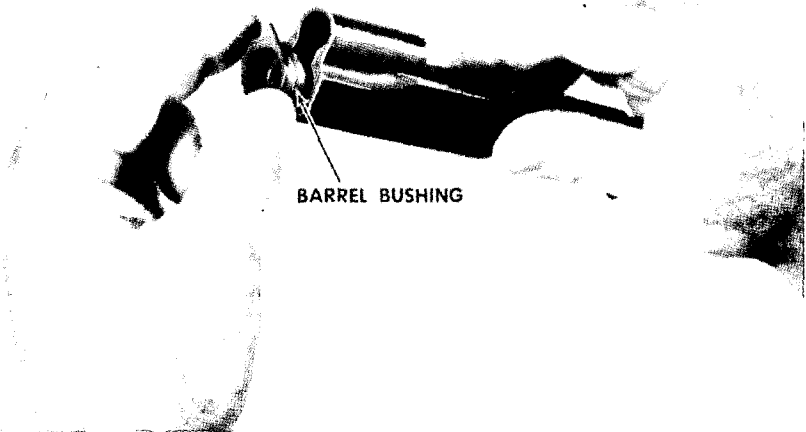

Figure 8. Remove the barrel bushing by turning it counterclockwise and pulling it from the slide.

forward and rests against the hole in the recoil spring guide (fig. 6).

d. Assembling the Receiver Group to the Slide Group. Hold the slide with the sights down in the palm of one hand. Invert the receiver (the safety lock must be in the FIRE position) and engage the guide rails of the receiver in the grooves of the slide (fig. 6). Push the receiver all the way forward on the slide with a quick motion.

e. Slide Stop. Hold the pistol as shown in figure 5. Look through the slide stop pin hole in the receiver for alinement of this hole with the hole in the barrel link. If the holes are not alined, move the muzzle end of the barrel forward or rearward to aline them. Insert the slide stop pin into the holes. Move the slide forward until the disassembly notch is over the square hole in the left side of the receiver (fig. 5). Press the slide stop up and in to fully seat it. In some cases, a drift may be required to depress the slide stop plunger in order to fully seat the slide stop.

f. Recoil Spring Plug. Push the slide fully forward on the receiver and press the safety lock upward to the SAFE position. Place the recoil spring plug on the recoil spring. Turn the recoil spring plug clockwise to lock the plug to the recoil spring. Holding the pistol as shown in figure 4, insert the recoil spring and push downward on the recoil spring plug, compressing the spring until the plug is inside the slide. Turn the barrel bushing counterclockwise to lock the recoil spring plug in place. Press the safety lock downward to the FIRE position and squeeze the trigger.

g. Magazine. Insert the magazine into the magazine recess of the pistol until it is fully seated and held by the magazine catch (fig. 3). This completes general assembly.

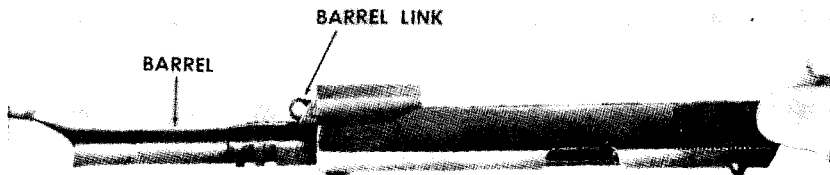

Figure 9. Push the barrel link forward and remove the barrel from the front end of the slide. This completes general disassembly.

12. Detailed Disassembly

Detailed disassembly is the disassembly of the receiver, the slide, and the magazine. If no drifts are available, the receiver should be disassembled first, because the safety lock and hammer strut can then be used as tools for disassembly of the remaining parts. To perform detailed disassembly of the pistol, perform general disassembly first (figs. 3 through 9).

13. Detailed Disassembly of the Receiver Group

Follow the procedure shown in figures 11 through 18. Completed detailed disassembly is shown in figure 19.

14. Detailed Disassembly of the Slide Group

Follow the procedure shown in figures 20 and 21. Completed detailed disassembly is shown in figure 22.

15. Detailed Disassembly of the Magazine Assembly

Push the follower downward in the magazine to compress the spring at least 1 inch. Place the hammer strut or a drift through one of the holes in the magazine tube to hold the spring compressed. Remove the magazine follower. Hold the magazine with the hand covering the mouth of the magazine to prevent the

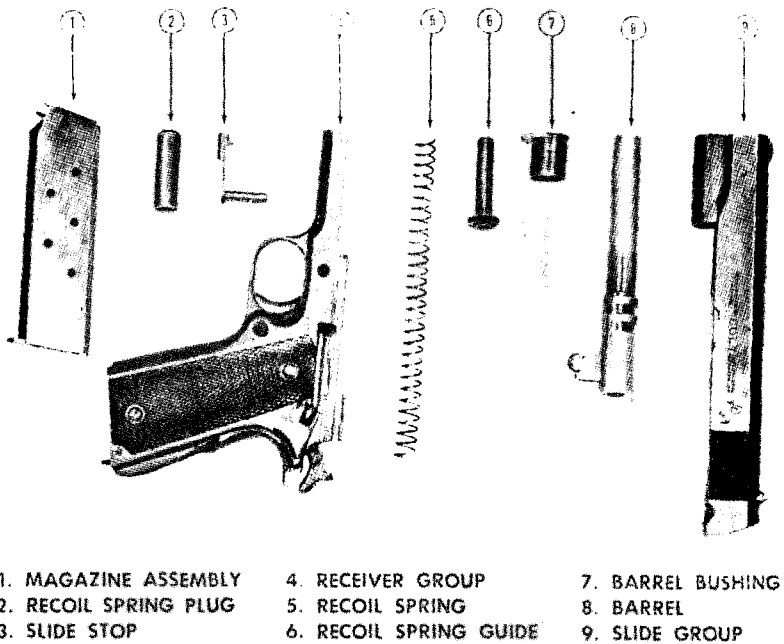
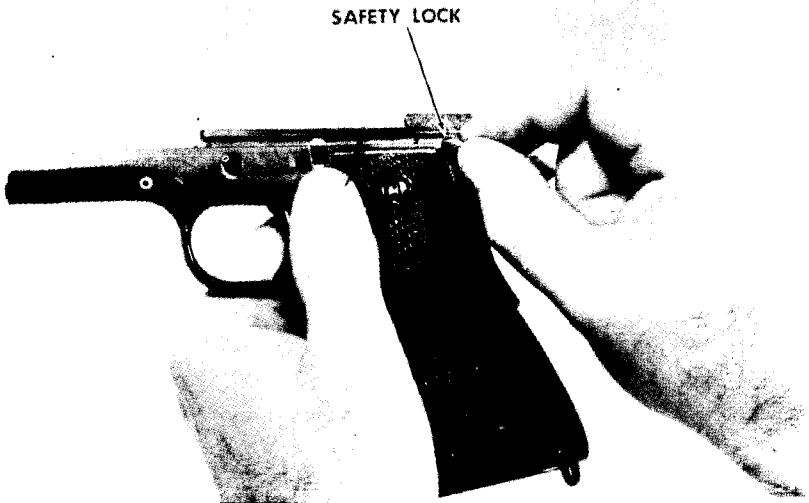

Figure 10. Parts of the pistol in order of general disassembly.



*Figure 11. To remove the safety lock, cock the hammer, grasp the safety lock, move it midway between the *SAFE* and *FIRE* positions, and withdraw it from the receiver.*



Figure 12. Hold the hammer, squeeze the trigger, and ease the hammer forward. Using the safety lock as a drift, press out the mainspring housing pin.



Figure 13. To remove the grip safety, slide the mainspring housing down about $\frac{1}{2}$ inch and lift out the grip safety. Remove the mainspring housing by sliding it from the receiver. Disassemble the mainspring housing only when necessary for cleaning.

spring from jumping out, pull the hammer strut or drift from the hole in the magazine tube, catch the spring, and withdraw it (fig. 23).

16. Assembly of the Magazine Assembly

Place the magazine spring in the magazine tube and compress it at least one inch below the top of the tube. (The ends of the magazine spring are different. See figure 23 for correct relationship of parts for assembly.) Hold the spring compressed by inserting the hammer strut or a drift through a hole in the magazine tube over the top of the spring. Slide the follower into the magazine tube. Remove the hammer strut or drift carefully, allowing the magazine spring to expand and push the magazine follower up against the lips of the magazine tube.

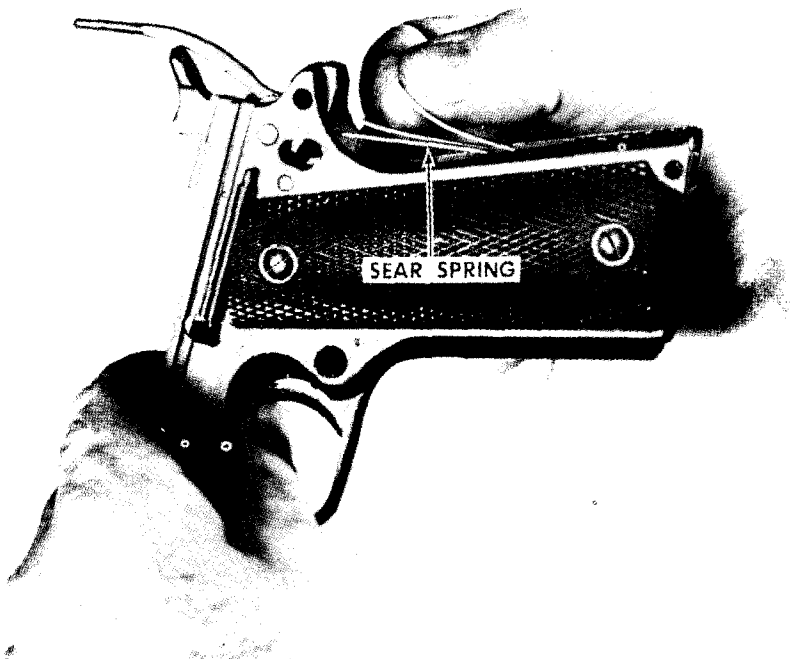

Figure 14. Lift out the sear spring.

17. Assembly of the Slide Group

Place the firing pin in the small end of the firing pin spring. Insert the firing pin spring, the firing pin, and the extractor into their recesses in the rear of the slide. Be sure that the extractor is aligned correctly to allow the firing pin stop to enter its recess. Push the firing pin forward until it clears the firing pin stop position, then replace the firing pin stop.

18. Assembly of the Receiver Group

a. Replace the stocks and stock screws.

b. Replace the slide stop plunger (smaller of the two plungers), the plunger spring, and the safety lock plunger in the plunger tube (fig. 18) until the safety lock plunger is nearly flush with the rear of the plunger tube.

c. Replace the trigger as shown in figure 24.

d. Insert the magazine catch lock into the magazine catch spring and replace these parts in the magazine catch. Using the short leaf of the sear spring as a screwdriver, press the lock in and turn it counterclockwise to lock the magazine catch together.

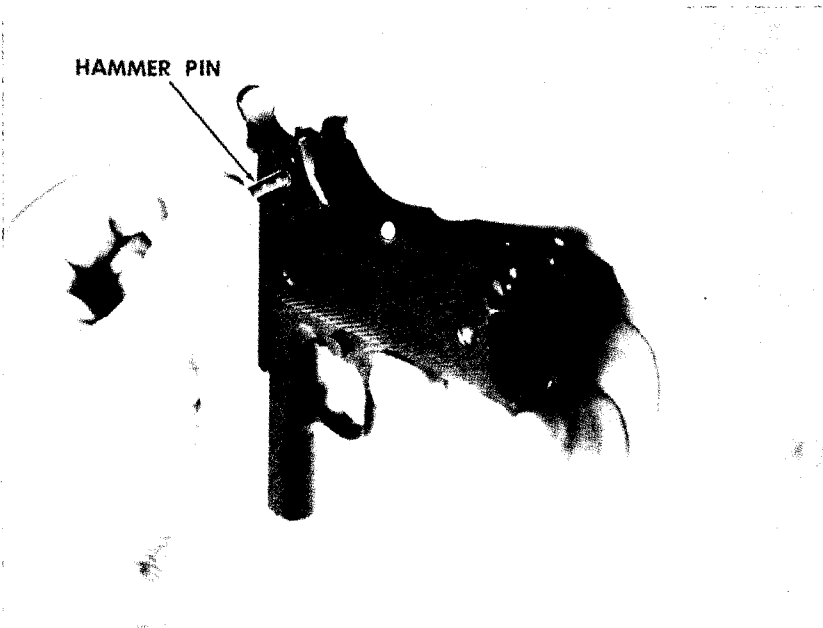

Figure 15. Remove the hammer pin from the left side of the receiver.

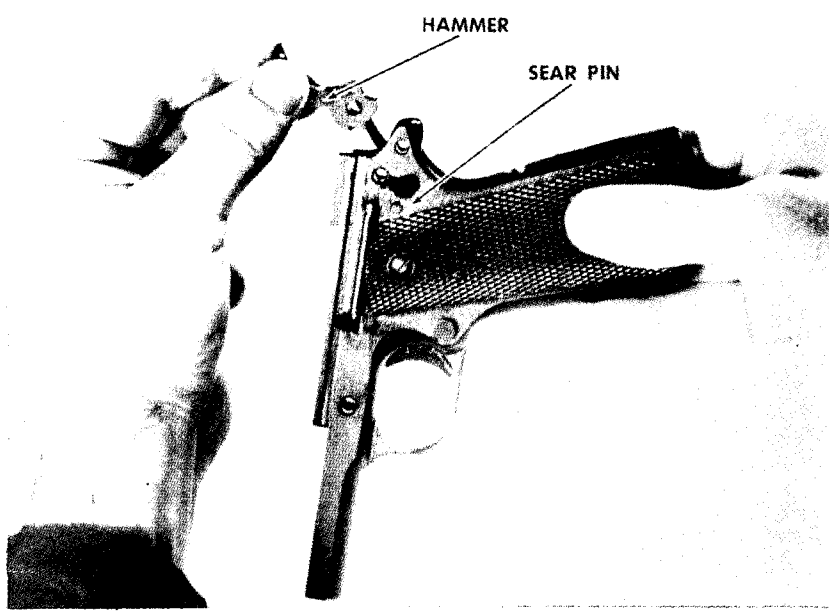

Figure 16. Lift the hammer from the receiver. Drift out the hammer strut pin (fig. 19) and separate the parts. (Caution: If the hammer strut pin is peened in place, do not remove it.) Remove the sear pin from the left side of receiver. Elevate the front end of the receiver and allow the sear and disconnecter to drop into the hand.



Figure 17. Press the magazine catch in until it is flush with the left side of the receiver. Using the short leaf of the sear spring as a screwdriver, turn the lock $\frac{1}{4}$ turn counterclockwise. The lock should turn easily. If it does not check to see that the magazine catch is flush with the left side of the receiver. Force should not be used to turn the lock. Lift out the magazine catch. (Caution: Do not use the long leaf of the sear spring as a screwdriver.) To disassemble the magazine catch, turn the lock clockwise and separate the parts. Remove the trigger by elevating the front end of the receiver.

Place the magazine catch in its recess in the receiver (fig. 17) and press the magazine catch flush with the left side of the receiver. Using the short leaf of the sear spring as a screwdriver, turn the magazine catch lock clockwise until the magazine catch snaps into its position in the receiver.

e. Assemble the sear and disconnector as shown in figure 25. Insert the round end of the disconnector into its hold in the top of the receiver, so that the flat face of the disconnector rests against the rear of the trigger.

f. To replace the sear pin, hold the receiver in the right hand, front end of the receiver pointed down. Place the right forefinger on the trigger and the thumb on the sear and disconnector. Aline the sear pin hole in the receiver, sear, and disconnector by

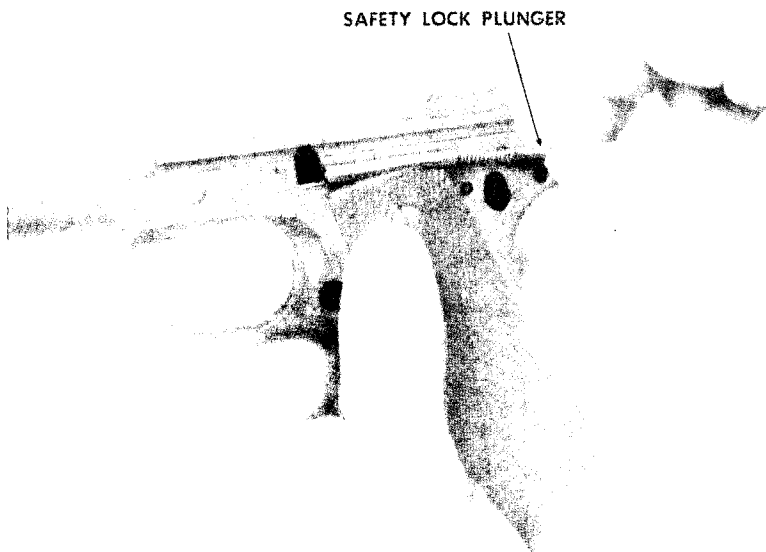

Figure 18. Withdraw the safety lock plunger, slide stop plunger, and plunger spring. Remove the stock screws and stocks from the receiver.

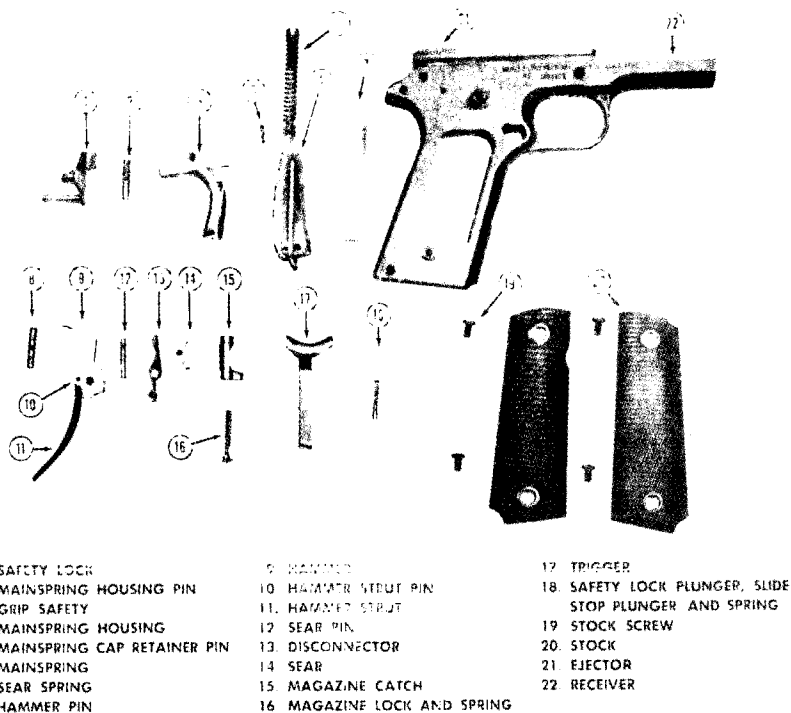

Figure 19. Parts of the receiver group in order of detailed disassembly.

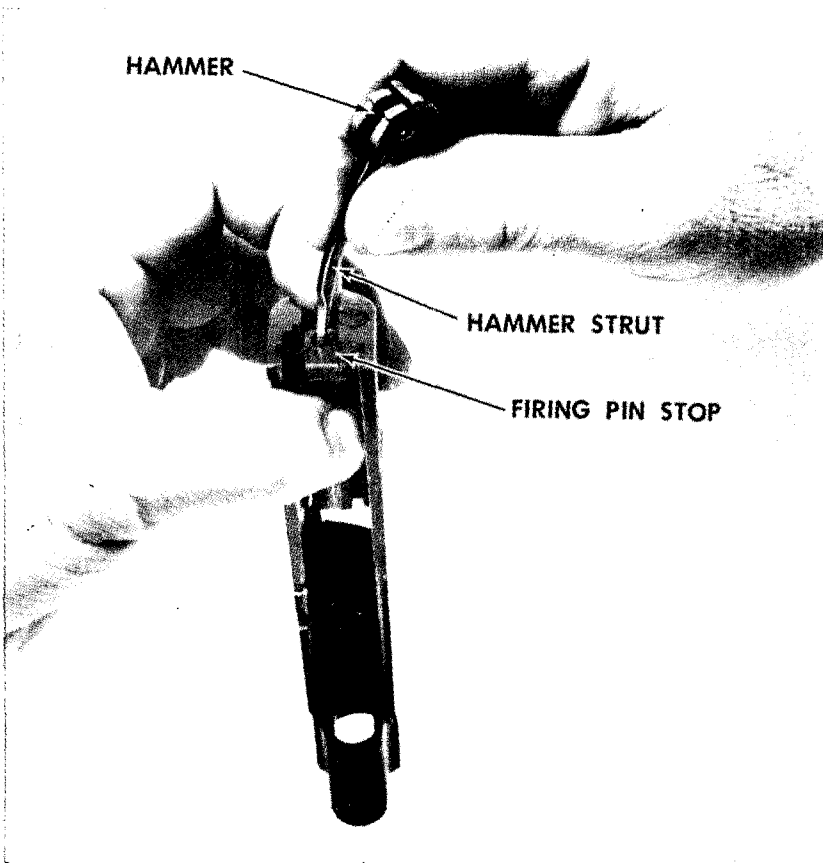

Figure 20. Using the hammer strut as a drift, press in on the firing pin and remove the firing pin stop. Remove the firing pin and firing pin spring. Separate the two parts.

use of the thumb and forefinger and replace the sear pin from the left side.

g. Assemble the hammer, hammer strut, and hammer strut pin. Place the hammer in the receiver (fig. 16), align the hammer pin hole of the receiver and hammer, and insert the hammer pin (fig. 15).

h. Replace the sear spring as shown in figure 14. The sear spring must rest in its recess in the rear of the receiver and the long leaf must rest on the sear.

i. Assemble the mainspring housing (if disassembled) and slide it upward $\frac{2}{3}$ of the way into the receiver (fig. 13).

j. Lower the hammer strut into the receiver and replace the grip safety (fig. 13). While holding the grip safety in position, tilt the receiver to allow the hammer strut to position itself in

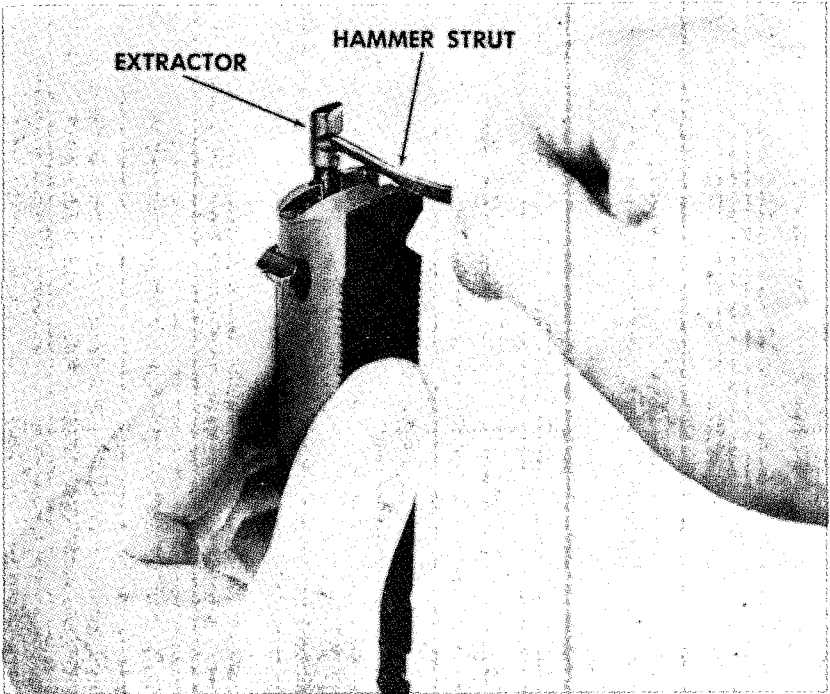

Figure 21. With the hammer strut, pry out and remove the extractor.

line with the mainspring cap (fig. 26). Push mainspring housing up until it is fully seated in the receiver.

k. Place the rounded end of the mainspring housing pin in its hole in the receiver. Rest the other end of the pin on a hard surface and strike the opposite side of the receiver to fully seat the pin.

l. To replace the safety lock, cock the hammer and insert the safety lock pin through the holes in the receiver and grip safety. Position it as shown in figure 11 and press in and down to seat it fully.

Note. The use of a drift may be necessary to depress the safety lock plunger.

m. Complete the assembly of the pistol as described in paragraph 11.

19. Test for Correct Assembly

To test the pistol for correct assembly, pull the slide fully to the rear and release it by pushing down on the slide stop; the hammer should remain cocked. Hold the pistol in a normal grasp to depress the grip safety and squeeze the trigger. The hammer should fall.

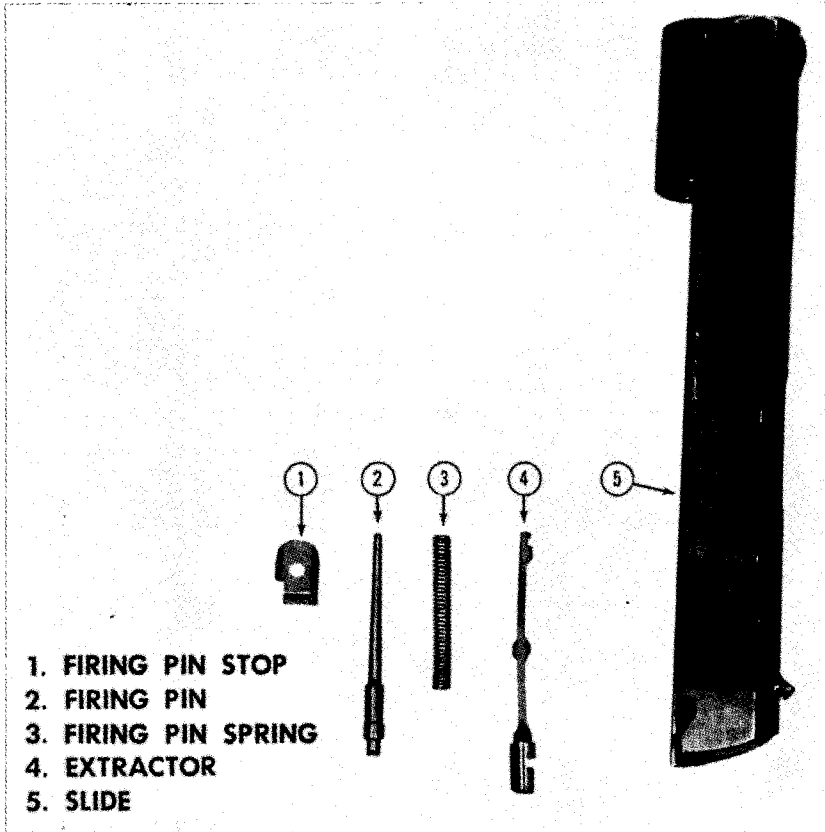

Figure 22. Parts of the slide in order of detailed disassembly.

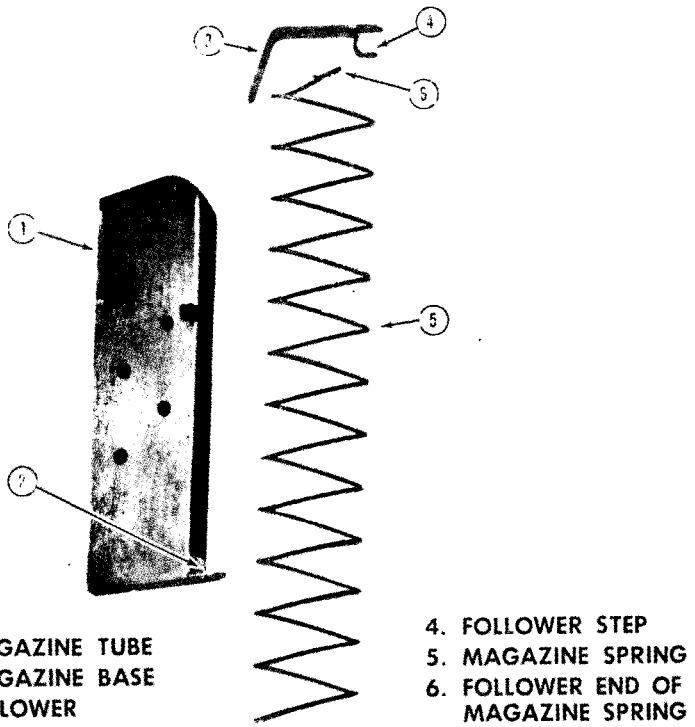

Figure 23. The magazine assembly shown in detailed disassembly.

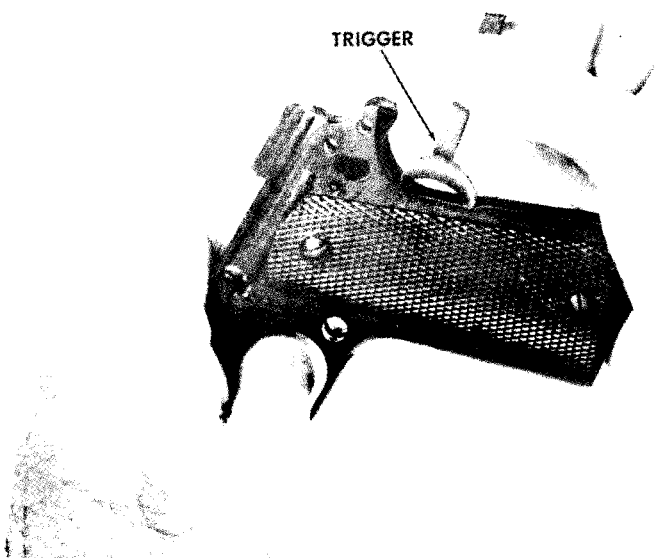

Figure 24. Replacing the trigger.



SEAR
DISCONNECTOR

Figure 25. Replacing the sear and disconnector.

Section II. FUNCTIONING OF THE PISTOL

20. General

a. By disassembling and assembling the pistol, the soldier becomes familiar with the parts. The next step in mechanical training is to learn how these parts function. If the soldier understands how the pistol functions, he will be able to keep it in operating condition and reduce stoppages that may occur during firing. This knowledge will give the soldier confidence in the weapon.

b. Each time a cartridge is fired, the parts inside the pistol function in a given order. This is known as the cycle of operation (functioning).

c. The cycle of operation of the pistol is divided into eight basic steps, which are listed below in the order they occur; however, more than one step may be occurring at the same time.

- (1) *Feeding*—placing a cartridge in the receiver, approximately in back of the barrel, ready for chambering.
- (2) *Chambering*—moving the cartridge from the magazine into the chamber.
- (3) *Locking*—sealing the cartridge in the chamber and blocking the breech end of the barrel.
- (4) *Firing*—igniting the primer and firing the cartridge.
- (5) *Unlocking*—unsealing the breech end of the barrel.
- (6) *Extracting*—removing the cartridge case from the chamber.
- (7) *Ejecting*—removing the cartridge case from the weapon.
- (8) *Cocking*—returning the firing mechanism to the cocked position ready to fire another cartridge.

21. Functioning of the Pistol, General

a. A magazine containing ammunition is placed in the receiver and the slide is pulled fully to the rear and released. As the slide moves forward, it strips the top round from the magazine and pushes it into the chamber. The hammer remains in the cocked position (fig. 26) and the pistol is ready to be fired.

b. The pistol fires one round each time the trigger is squeezed. Each time a cartridge is fired, the slide and barrel recoil (moves rearward) locked together a short distance. This permits the bullet and expanding powder gases to escape from the muzzle before unlocking is completed. The barrel then unlocks from the slide, and the slide continues its rearward movement, extracting the cartridge case from the chamber and ejecting it from the weapon. During rearward movement, the magazine feeds another cartridge, the recoil spring is compressed, and the hammer is cocked. At the termination of rearward movement, the recoil spring expands and forces the slide forward, and the cycle of operation continues until the ammunition in the magazine is expended. As the last round is fired, the magazine spring exerts upward pressure on the magazine follower, and the step on the follower strikes the slide stop and raises it, forcing the slide stop to engage in the slide stop recess on the bottom of the slide and holding it in the rear position. This action serves as an indicator that the magazine is empty and permits faster loading.

22. Feeding

When a magazine containing ammunition is inserted into the receiver (slide forward), the top cartridge in the magazine con-

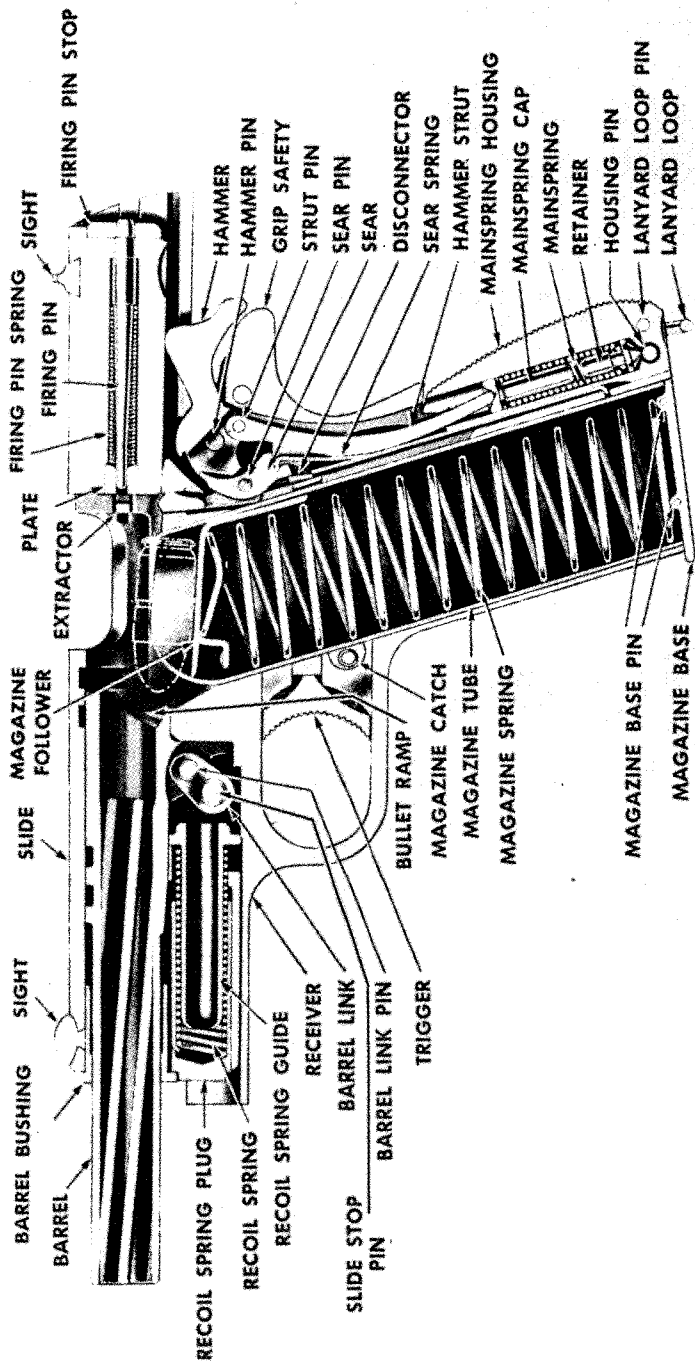

Figure 26. Cutaway view of the M1911A1 pistol.

tacts the bottom of the slide. This pushes the ammunition deeper into the magazine, forcing the follower down and further compressing the magazine spring. When the magazine is fully seated in the receiver, the magazine catch enters its recess and holds the magazine in place. Feeding takes place as the slide moves rearward off the top of the magazine. At this time, the expanding magazine spring forces the follower and the ammunition up until the top cartridge is held by the magazine lips, ready for chambering. Feeding is then complete.

23. Chambering

At the termination of the rearward movement of the slide the expanding recoil spring forces the slide forward. The lower portion of the face of the slide passes between the lips of the magazine, strips the top cartridge from the magazine, and pushes it to the bullet ramp and up into the chamber. During this movement, the base of the cartridge slides up the face of the slide for chamber alinement. At this time, the extractor enters the extractor groove on the base of the cartridge case. Chambering is complete when the cartridge is fully seated in the chamber, and the face of the slide is against the rear extension of the barrel.

24. Locking

After chambering is completed, the slide continues its forward movement and pushes the barrel forward. As the slide continues to exert force against the rear of the barrel, the barrel pivots up and forward on the barrel link. At this time, the locking ribs on the barrel enter the locking recesses in the slide, thereby locking the barrel to the slide. The forward movement of the recoiling parts terminates when the barrel lugs strike the slide stop pin.

25. Firing

a. For the pistol to fire, the slide must be fully forward to complete the linkage between the trigger, disconnecter, and sear. The grip safety must be pressed inward in order to elevate the forward projection on the grip safety. This causes it to clear the trigger and allows trigger movement rearward.

b. When the trigger is squeezed, the trigger yoke presses against the disconnecter, which in turn transmits this movement to the sear. The sear rotates on the sear pin and disengages from the *full cock* notch of the hammer. The expanding mainspring pushes the hammer strut up, forcing the hammer to rotate forward on the hammer pin and strike the firing pin. The inertia-type firing pin travels forward, compressing the firing pin spring.

The firing pin striker moves through the firing pin well in the face of the slide and strikes the cartridge primer. The primer ignites the propellant and the expanding powder gases force the bullet through the barrel. The firing pin spring expands and withdraws the firing pin from the face of the slide.

26. Unlocking

The powder gases exert equal pressure in all directions, but because the resistance of the recoil spring and the weight of the slide and barrel are so much greater than the weight of the bullet, these parts react more slowly than the bullet. This allows the bullet to leave the barrel before unlocking is completed. As the slide and barrel move rearward, the barrel pivots to the rear and down on the barrel link, separating the barrel locking ribs from the locking recesses in the slide, and unlocking is completed.

27. Extracting

The slide continues its rearward movement and the extractor, engaged in the extractor groove of the cartridge, withdraws the cartridge case from the chamber. Extraction is completed as the cartridge case clears the chamber.

28. Ejecting

As the slide continues to move rearward, the cartridge case, which is held against the face of the slide by the extractor, strikes the ejector on the receiver, pivots on the extractor, and is ejected from the pistol.

29. Cocking

Cocking begins as the slide starts rearward in recoil. At this time, the firing pin stop pushes the hammer rearward. As the hammer moves rearward, the hammer strut is pushed down against the mainspring cap, compressing the mainspring. Rearward movement of the slide terminates as the slide strikes the recoil spring guide collar, which rests against the receiver. The expanding recoil spring causes the slide to begin its forward movement. As the slide moves forward, the hammer follows it for a short distance; then the sear, which is bearing against the hammer through the action of the sear spring, enters the *full cock* notch of the hammer and holds it in the cocked position. When the slide is fully forward and the trigger is released, the disconnector positions itself in its recess in the bottom of the slide and cocking is completed.

30. Action of the Sear and Disconnecter

a. The disconnecter is the device that causes the pistol to fire semiautomatically. The disconnecter forms a linkage between the trigger and the sear that is broken when the slide is not fully forward or if the trigger is held to the rear. When the slide is fully forward, the top of the disconnecter rests in its recess in the bottom of the slide. At this time, the flat face on the lower portion of the disconnecter, which always rest against the trigger yoke, is up and in front of the lower sear lugs. The center leaf of the sear spring applies continuous forward and upward pressure to the disconnecter to position the disconnecter and the trigger.

b. As the trigger moves to the rear, the trigger yoke pushes the disconnecter against the sear lugs. As the sear lugs are forced rearward, the sear rotates on the sear pin, causing the sear to disengage from the *full cock* notch and release the hammer.

c. As the slide moves rearward, the disconnecter recess in the bottom of the slide overrides the top of the disconnecter. The disconnecter is then forced down by the bearing surface on the bottom of the slide. The hole through the disconnecter is much larger than the diameter of the sear pin; this allows up and down movement of the disconnecter. As the disconnecter moves downward, the lower portion drops below and breaks contact with the sear lugs.

d. When the slide is not fully forward the connecting linkage is broken and the sear functions independently of the trigger and disconnecter. At this time the left leaf of the sear spring pushes forward on the left sear lug, causing the sear nose to continuously bear against the hammer. After the hammer moves forward a short distance, the sear nose engages the *full cock* notch on the hammer and holds the hammer in the cocked position.

e. After the slide returns forward, the trigger must be released to allow the disconnecter to reposition before another cartridge can be fired. Upon release of the trigger, the center leaf of the sear spring pushes the disconnecter forward and up. The top of the disconnecter enters its recess in the bottom of the slide. The lower portion of the disconnecter positions itself in front of the sear lugs and completes the linkage among the trigger, disconnecter, and sear.

31. Safety Devices

The pistol has three safety devices: the grip safety, the safety lock, and the *half cock* notch on the hammer. The safeties must be

tested often and always before the pistol is fired. The disconnecter is not considered a positive safety, as are the three safeties mentioned above, since it is designed to cause the pistol to fire semiautomatic fire and cannot be controlled by the firer.

32. Operational Tests Before Firing

Warning: Before making the following tests inspect to insure that the magazine is removed and the chamber is empty.

a. *Safety Lock.* Cock the hammer and press the safety lock up into the SAFE position. Grasp the stock so that the grip safety is depressed and squeeze the trigger three or four times. If the hammer falls, the safety lock is not safe and must be replaced.

b. *Grip Safety.* Cock the hammer and, being careful not to depress the grip safety, point the pistol down, and squeeze the trigger three or four times. If the hammer falls, the grip safety or sear spring must be replaced.

c. *Half Cock Notch.* Pull the hammer rearward until the sear engages the *half cock* notch and squeeze the trigger. If the hammer falls, the hammer or sear must be replaced. Pull the hammer rearward nearly to the *full cock* notch and let it fall. It should fall only to the *half cock* notch.

d. *Disconnecter.* Cock the hammer and push the slide $\frac{1}{4}$ inch to the rear; hold the slide in that position and squeeze the trigger. Let the slide go forward, maintaining the pressure on the trigger. If the hammer falls, the disconnecter is worn and must be replaced. Pull the slide all the way to the rear, squeeze the trigger and release the slide; the hammer should not fall. Release the pressure on the trigger, squeeze it, and the hammer should fall. The disconnecter prevents the release of the hammer until the slide and barrel are fully forward and locked. If the hammer falls upon release of the slide, the disconnecter should be replaced.

Section III. LOADING, FIRING, AND UNLOADING

33. Load

Draw the pistol from the holster and hold it at the position of *raise pistol* (fig. 29). Insert a magazine loaded with from one to seven rounds of ammunition. Grasp the slide with the left hand, thumb on the right side of slide as shown in figures 27 and 28. Pull the slide fully to the rear, release, and press the safety lock up to the SAFE position with the left forefinger.

34. Fire

To fire the pistol, press the safety lock down to the FIRE position with the left thumb to prevent disturbing the firing grip



Figure 27. Load.

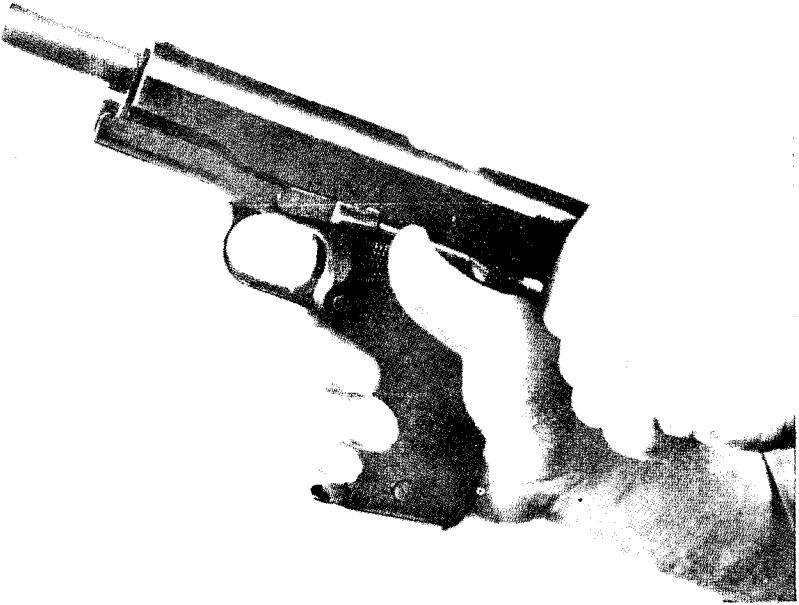

Figure 28. Position of hands at load.

of the right hand. Obtain the correct sight alignment and sight picture and squeeze the trigger. To fire successive shots, the trigger must be released and squeezed again. When the last cartridge from the magazine has been fired, the slide remains to the rear.

35. Unload

To unload, come to the position of *raise pistol*. Press the magazine catch and remove the magazine (fig. 30). If the slide is in the forward position, pull the slide to the rear and push the slide stop up. Inspect the chamber to insure that the pistol is clear. Press the slide stop down, allowing the slide to go forward. Remaining at *raise pistol*, squeeze the trigger; then holster the weapon.

Section IV. MALFUNCTIONS, STOPPAGES, AND IMMEDIATE ACTION

36. General

The pistol is a mechanical device and, as parts become worn, broken, dirty, or dry, stoppages may occur during firing. Sufficient knowledge of malfunctions, stoppages, and immediate action is

required to find and correct malfunctions or stoppages in a minimum of time.

37. Malfunctions

A malfunction is a failure of the weapon to function satisfactorily. Malfunctions are classified as defects in the weapon that normally do not cause a break in the cycle of operation. These may be discovered when the operational tests are being performed (par. 32). The following are some malfunctions and their causes:

a. The grip safety does not block the trigger; a faulty sear spring.

b. The slide does not remain to the rear after the last round is fired; a worn or broken magazine follower step, slide stop, or a weak or broken magazine spring.

38. Stoppages

a. A stoppage is any unintentional interruption in the cycle of operation. If the pistol stops firing through no fault of the firer, or an attempt to fire is made and the weapon does not fire, then a stoppage has occurred.

b. Stoppages are classified in accordance with the eight steps in the cycle of operation. Stoppages are usually the result of worn parts or improper care of the weapon. A knowledge of functioning enables the soldier to classify and correct stoppages. The following are the main classifications of stoppages and their causes:

- (1) *Failure to feed.* The top cartridge in the magazine is not properly positioned behind the barrel and in the path of the slide. Caused by—
 - (a) Dirty or dented magazine.
 - (b) Weak or broken magazine spring.
 - (c) Worn or broken magazine catch.
 - (d) Improper assembly (magazine spring backwards).
 - (e) Bent magazine follower.
- (2) *Failure to chamber.* The top cartridge from the magazine is not fully seated in the chamber. Caused by—
 - (a) Dirty chamber.
 - (b) Dented cartridge case.
 - (c) Weak recoil spring.
 - (d) Obstruction in the chamber.
 - (e) Lack of lubrication.

- (f) Extractor applying too much pressure on the right side of the cartridge.*
- (3) *Failure to lock.* The barrel locking ribs do not interlock with the locking recesses in the slide. Caused by—
- (a) Lack of lubrication of operating parts.
 - (b) Burred or dirty barrel locking ribs or locking recesses.
 - (c) Weak recoil spring.
 - (d) Broken barrel link.
 - (e) Extractor applying too much pressure on the right side of the cartridge.*
- (4) *Failure to fire.* The hammer falls but the primer of the cartridge is not ignited. Caused by—
- (a) Faulty ammunition.
 - (b) Broken firing pin.
 - (c) Bent or broken hammer strut.
 - (d) Weak mainspring.
- (5) *Failure to unlock.* The barrel locking ribs do not disengage from the locking recesses in the slide. Caused by—
- (a) Broken barrel link.
 - (b) Broken barrel link pin.
 - (c) Broken barrel lugs.
- (6) *Failure to extract.* The cartridge case is not removed from the chamber. Caused by—
- (a) Broken or worn extractor.
 - (b) Dirty or pitted chamber.
- (7) *Failure to eject.* The cartridge case is not ejected from the pistol. Caused by—
- (a) Faulty extractor (does not position the cartridge case for ejection).
 - (b) Broken ejector.
- (8) *Failure to cock.* The hammer does not return to the cocked position. Caused by—
- (a) Worn *full cock* notch on the hammer.
 - (b) Worn sear.
 - (c) Defective sear spring.
 - (d) Worn or broken disconnecter.

*The extractor groove in steel cased ammunition is shorter than that of brass cases. The extractor was designed for use with brass cases. When firing with steel cased ammunition, the extractor, in many instances, will not fully seat in the extractor groove. This will create friction during the forward movement of the slide, particularly with tight fitted weapons. Modification of the extractor is permitted only by Ordnance personnel, or specially trained Armorers.

39. Immediate Action

a. Immediate action is the prompt action taken by the firer to reduce a stoppage. The procedure for applying immediate action should become instinctive for the soldier armed with the pistol. If a stoppage occurs, immediate action is applied automatically in an effort to reduce the stoppage without attempting to discover the cause at that time.

b. In the event the slide is fully forward, the hammer falls, and the pistol fails to fire, apply immediate action as follows:

- (1) Manually cock the hammer without opening the chamber and make one additional attempt to fire. If the pistol still fails to fire, wait 10 seconds, and then come to the position of *raise pistol*. Grasp the slide with the thumb and first finger of the left hand, keeping the thumb on the right side of the slide. Pull the slide rearward rapidly, to its full extent. Rotate the pistol to the right allowing the unfired round to drop out, release the slide and allow it to return to the forward position, chambering a new cartridge.

Caution: Keep the weapon pointed downrange during this operation.

- (2) Aim and attempt to fire.

c. In the event the slide is not fully forward, remove the trigger finger from the trigger guard and with the non-firing hand attempt to push the slide fully forward. If the slide will not move forward, proceed as follows:

- (1) Bring the weapon to *raise pistol*.
- (2) Remove the magazine.
- (3) Grasp the slide with the left hand as in *inspection arms*, pull the slide to the rear, and lock it with the slide stop.
- (4) Inspect the chamber. Remove any obstructions.
- (5) Insert another loaded magazine into the pistol.
- (6) Release the slide.
- (7) Aim and attempt to fire.

d. If the weapon does not fire after application of immediate action as outlined above, a detailed inspection should be made to determine the cause of the stoppage.

Section V. CARE AND CLEANING

40. General

Care and cleaning of the pistol includes daily preventive maintenance, which is that ordinary care of the pistol required to

preserve its condition and appearance when no firing is done. Before-firing cleaning insures that the pistol is safe to fire and is properly lubricated for efficient operation, and after-firing cleaning insures that all corrosion-inducing agents deposited in the bore and chamber of the pistol are completely removed.

41. Cleaning Materials, Lubricants, and Rust Preventives

a. Cleaning Materials.

- (1) Cleaning compound, solvent (rifle bore cleaner), is used to clean the bore and the face of the slide after firing. It dissolves corrosive primer salts and removes powder ash and carbon. This cleaner has preservative properties and provides temporary protection against rust.

Caution: Rifle bore cleaner is usable at temperatures of minus 20° Fahrenheit and higher. Do not mix water with rifle bore cleaner. This destroys its preservative qualities and impairs its value as a cleaner.

- (2) Hot soapy water may be used to clean the bore when rifle bore cleaner is not available. One-quarter pound of soap dissolved in one gallon of water makes a desirable cleaning solution. After using the solution, dry the barrel thoroughly and apply a light coat of oil.
- (3) Volatile mineral spirits, paint thinner, and dry-cleaning solvent are noncorrosive solvents used for removing oil, grease, or light rust-preventive compounds from weapons. Apply these cleaning agents with a rag to large parts, and use it as a bath for small parts.

Caution: These solvents are highly flammable. Do not smoke when using them. Continuous contact with them will dry the skin and may cause irritation.

- (4) Decontaminating agents are used under special conditions to remove chemical agents (par. 46).
- (5) The swab, small arms cleaning, is a good grade of unbleached, single-base, napped flannel cotton. Swabs are in the form of cut patches, 2½ inches square, and are used for the cleaning of bores of small arms.
- (6) Rags, wiping, cotton, are soft and absorbent cloth, usually composed of light clothing rags, free from dust, alkali, and corrosive agents. Rags are used to clean small arms and other items of equipment.

b. Lubricants.

- (1) Lubricating oil, general purpose, PL medium, is a highly

refined, nonhardening mineral oil containing a rust inhibiting additive. It forms a relatively heavy film that resists direct action of salt spray. This makes it useful for coating all parts of a weapon before amphibious operations. It should be used in preference to lubricating oil, general purpose, PL special, only when the weapon is exposed to salt water, high humidity, or high temperatures. This oil should not be used in temperatures below freezing.

- (2) Lubricating oil, general purpose, PL special, is a thin oil used for lubricating at below freezing temperatures, and for providing temporary protection against rust. When this oil is used, moving parts of weapons must be inspected frequently to make sure that they have an adequate film of lubricant.
- (3) Engine oil, SAE 10, may be used when preservative lubricating oils cannot be obtained. In cold weather, any heavy oil will cause sluggish operation, and may prevent the pistol from functioning properly. Engine oil does not contain the rust-preventive properties of lubricating, preservative oils. When engine oil is used, the pistol must be inspected, cleaned, and oiled frequently.

42. Daily Preventive Maintenance

a. Damp air and sweaty hands are great promoters of rust. Pistols should be cleaned and protected with oil after every drill or handling. The pistol should be inspected each day and cleaned if necessary.

b. To clean the pistol, rub it with a rag lightly saturated with oil, and then rub with a dry rag. Clean the bore with a swab saturated with oil, then with a dry swab. Dust out all crevices with a small, clean brush.

c. To protect the pistol after it has been cleaned, cover all the surfaces, including the bore and chamber, with a light coat of lubricating, preservative oil.

d. After cleaning and oiling the pistol, place it in the pistol rack. The use of canvas or similar covers is prohibited, since they collect moisture, which rusts the metal.

43. Care and Cleaning Before Firing

Before the pistol is fired, the bore and chamber and exterior parts of the receiver of the pistol should be cleaned and dried. The guide rails on the receiver and the grooves on the slide should be lubricated with oil. A light coat of oil should be placed on all

other interior metal parts except those that come into contact with ammunition. Excess oil should be removed from the grips and the grip area of the receiver to aid the firer in gripping the weapon.

44. Care and Cleaning After Firing

The pistol must be cleaned as soon as practicable on the day of firing and daily for the next three days, or longer if necessary, in the following manner:

- a. Disassemble the pistol.
- b. Clean all parts with a rag lightly saturated with oil. Dry all parts and apply a light coat of oil.
- c. Clean the bore and chamber as follows:
 - (1) Wet a swab with rifle bore cleaner and run it back and forth through the bore several times.
 - (2) Attach the pistol bore brush to the cleaning rod and run it through the bore and chamber several times.
 - (3) Run dry swabs through the bore and chamber until they are clean.
 - (4) Inspect the bore for cleanliness. If it is not free of all residue, repeat the cleaning process.
 - (5) When the chamber and bore are clean, coat them with rifle bore cleaner and leave overnight.
 - (6) Assemble the pistol.
 - (7) Perform the test for correct assembly (par. 19).
 - (8) Apply a light coat of oil to the exterior surfaces of the pistol.
 - (9) After the third daily cleaning, if the bore and chamber are clean, remove the rifle bore cleaner and replace with a light coat of lubricating, preservative oil.

45. Care and Cleaning Under Unusual Climatic Conditions

a. *Cold Weather.*

- (1) In temperatures below freezing, it is necessary that the moving parts of the weapon be kept free from moisture. Excess oil on working parts will solidify and cause sluggish operation or complete failure.
- (2) Before cleaning, allow the weapon to attain room temperature. Perform detailed disassembly and clean with dry-cleaning solvent or mineral spirits before use in temperatures below 0° F. Working surfaces that show signs of wear may be lubricated by rubbing lightly with a rag that has been wet with oil, lubricating, general purpose, PL special.

b. Hot Weather.

- (1) In tropical climates where temperature and humidity are high, or where salt air is present, and during rainy seasons the weapon should be inspected daily and kept lightly oiled. It should be disassembled daily and all parts dried and oiled.
- (2) In hot, dry climates where sand and dust may get into the mechanism and bore, all lubricants should be removed from the pistol, and it should be disassembled daily for thorough cleaning. It should be wiped clean as often as required.

46. Care and Cleaning After a CBR Attack

a. Before Attack. If a chemical, biological, or radiological (CBR) attack is anticipated, the following action is taken: Apply oil to all outer metal surfaces of the pistol. Do not apply oil to the ammunition. If the pistol is not to be used, cover the weapon, accessories, and ammunition with protective coverings and place them under natural cover. Ammunition should be kept in original containers as long as possible before anticipated use.

b. After Attack. After a CBR attack, determine by means of detectors whether or not the equipment is contaminated. A complete suit of protective clothing, including protective gloves and a gas mask, must be worn during decontamination. If the contamination is too great, it may be necessary to discard the equipment. Detailed information on decontamination is contained in FM 21-40 and TM 3-220.

47. Cleaning Pistols Received From Storage

Pistols removed from storage are coated with lubricating oil, general purpose, preservative, medium, or corrosion-preventive compound, class 2, (medium film). Weapons received from ordnance storage are usually coated with corrosion-preventive compound. Use mineral spirits or paint thinner to remove the compound or oil. Failure to thoroughly clean all the parts may cause a stoppage at below normal temperatures, since the corrosion-preventive compound will congeal during cold weather. After using mineral spirits or paint thinner, dry all parts with a dry cloth, and apply a thin film of appropriate lubricating oil.

Section VI. REPAIR PARTS AND ACCESSORIES

48. Repair Parts

a. Repair parts sets are provided for replacement and must be kept complete at all times. The allowance of these repair parts is prescribed in ORD 7, SNL B6.

b. The allowance of spare magazines issued with the pistol is also prescribed in ORD 7, SNL B6.

49. Accessories

The names or general characteristics of many of the accessories required for the pistol indicate their use and application. They consist of the hip holster, shoulder holster, and pistol cleaning kit. The pistol kit contains wire bore brushes, cleaning rods, pistol screwdrivers, an oiler, and a small brass can in which a set of repair parts is carried.

Section VII. AMMUNITION

50. General

a. The soldier armed with the pistol must be familiar with the types of ammunition for use in the pistol, ways of identifying each type of ammunition, and how to care for, handle, and use it.

b. A pistol cartridge is a complete assembly consisting of all the components necessary to fire the weapon once; that is, the cartridge case, bullet, propellant powder, and primer.

51. Classification of Ammunition

The contents of original boxes or containers can be identified by markings on the box. These markings indicate the number of cartridges in the container, the caliber, the type, the code symbol, and the lot number. The types, uses and means of identification of ammunition for use in the pistol are:

a. Cartridge, Caliber .45, Ball, M1911, is for use against personnel and light materiel targets. The ball bullet consists of a metal jacket surrounding a lead alloy core. The bullet tip is unpainted.

b. Cartridge, Caliber .45, Blank, M9, is used to simulate fire and for salutes. This cartridge can be fired single shot only in the pistol. It can be identified by the absence of a bullet and by its tapered mouth.

c. Cartridge, Caliber .45, Dummy, M1921, is used for training personnel in the operation of loading and unloading the pistol, and for testing weapons. It is used also in marksmanship training by being mixed with live ammunition during instruction practice firing. This cartridge can be identified by the empty primer pocket and two holes in the cartridge case.

d. Cartridge, Caliber .45, Tracer, M26, is used for observation of fire. Secondary uses are for incendiary effect and for signaling.

The bullet consists of three parts: a copper-plated steel, or guiding metal-clad, steel jacket; a slug of lead hardened with antimony; and a tracer mixture in the rear portion of the jacket. For identification the bullet is painted red for a distance of approximately $\frac{3}{16}$ of an inch from the tip.

52. Ammunition Lot Number

At time of manufacture, ammunition is assigned a lot number that is marked on all packing containers and is entered on all records pertaining to that ammunition. It must be included in all reports on the condition and functioning of the ammunition and in all reports of accident in which the ammunition is involved. Therefore, it is important to retain the lot number with the cartridges after they are removed from their original containers. If cartridges cannot be identified by ammunition lot number, they are automatically placed in grade 3. Grade 3 ammunition is unserviceable; it will not be fired, but will be turned in to the issuing ordnance officer.

53. Care, Handling, and Preservation of Ammunition

a. Small arms ammunition is generally safe to handle. However, do not allow ammunition boxes to become broken or damaged. Repair broken boxes immediately. Transfer all original markings to the new parts of the box.

b. Do not open ammunition boxes until the ammunition is to be used. Ammunition removed from airtight containers, particularly in damp climates, is likely to corrode, thereby becoming unserviceable.

c. Use care when opening wooden ammunition boxes, which can be continued in use as long as they are serviceable.

d. Protect ammunition from mud, sand, dirt, and water. If it appears wet or dirty, wipe clean with a dry cloth immediately. Wipe off light corrosion as soon as it is discovered. Cartridges with a heavy coat of corrosion must be turned in to the issuing ordnance officer.

e. Do not oil or polish cartridges.

f. Do not expose ammunition to the direct rays of the sun for any length of time. If the powder is heated, excessive pressure will be developed when the weapon is fired. This condition will affect accuracy and the operation of the weapon.

g. Do not attempt to fire cartridges that have dents, scratches, loose bullets, or corroded cases. If the cartridge is defective, turn it in. Do not throw away or attempt to destroy defective ammunition.

h. Do not strike the primer of a cartridge; it may ignite and cause injury.

54. Storage of Ammunition

a. Small arms ammunition is not an explosive hazard; however, under poor storage conditions it may become a fire hazard.

b. Small arms ammunition should be stored away from all sources of extreme heat.

c. Whenever practicable, small arms ammunition should be stored under cover. If necessary to leave ammunition in the open, it should be raised on dunnage at least six inches from ground. It should be covered with a double thickness of tarpaulin or suitable canvas. The cover should be placed so that it gives maximum protection, yet allows free circulation of air. Suitable trenches should be dug to prevent water from flowing under the ammunition.

55. Precautions in Firing Ammunition

The precautions concerning the firing and handling of ammunition in the field prescribed in AR 385-63 and TM 9-1990 must be observed. Precautions particularly applicable to small arms ammunition include the following:

a. No small arms ammunition will be fired until it has been positively identified by ammunition lot number and grade.

b. Before firing, the firer must be sure that the bore of the pistol is free from any foreign matter. Firing a pistol with any obstruction in the bore will result in damage to the weapon and possible injury to the firer.

56. Hangfire

a. A hangfire is a delay in the functioning of a propelling charge or explosive train at the time of firing. The amount of the delay is unpredictable but in most cases will be from a fraction of a second to several seconds. Thus, a hangfire cannot be distinguished immediately from a misfire and therein lies the principal danger—that of assuming that a failure of the weapon to fire immediately is a misfire when in fact it proves to be a hangfire. For this reason, the time interval of 10 seconds should be observed before the slide is opened after a failure to fire.

Caution: During the prescribed time interval keep the pistol pointed toward the target.

b. If the slide is fully forward and the pistol fails to fire, recock the hammer without opening the chamber, and make one

additional attempt to fire. If the pistol still fails to fire wait 10 seconds before pulling the slide to the rear to remove the cartridge from the chamber.

c. When a hangfire occurs in any lot, use of the ammunition in that lot should be suspended and a report made to the post ordnance officer, giving the number of the lot involved. The lot thus affected will be withdrawn and replaced by serviceable ammunition.

CHAPTER 3

MANUAL OF ARMS FOR THE PISTOL

57. General

- a. Pistol movements are not executed in cadence.
- b. During the manual of arms for the rifle, personnel armed with the pistol remain at attention except when the command INSPECTION ARMS or PRESENT ARMS is given.
- c. When PRESENT ARMS is given, the HAND SALUTE is executed.

58. Inspection Arms

At the command INSPECTION ARMS, execute the following movements in sequence. (These movements may be executed separately in response to the appropriate command.)

a. *Raise Pistol.* At the command RAISE PISTOL, unbutton the snap fastener of the shoulder holster with the right hand and grasp the receiver with the back of the hand facing outward. Draw the pistol from the holster. Bring the elbow in to the side and hold the forearm at an angle from the vertical, so that the hand is as high as, and approximately 6 inches in front of, the right shoulder. Hold the receiver with the thumb and last three fingers and extend the forefinger outside and along the trigger guard. Point the muzzle outward and up at an angle approximately 30 degrees from the vertical (fig. 29). If wearing a hip holster, at the command RAISE PISTOL, unbutton the flap, draw the pistol from the hip holster, and assume the position of *raise pistol*.

b. *Withdraw Magazine.* At the command WITHDRAW MAGAZINE, without lowering the right hand, turn the pistol slightly to the right and press the magazine catch with the right thumb (fig. 30). With the left hand, remove the magazine and place it between your belt and outer garment on the left side, with open end down and front to the right.

c. *Open Chamber.* At the command OPEN CHAMBER, without lowering the right hand, grasp the slide with the left thumb and first two fingers so that the thumb is on the left side of the slide and pointing down. Keeping the muzzle elevated, shift



Figure 29. Raise pistol.



Figure 30. Withdraw magazine.



Figure 31. Open chamber.



Figure 32. Inspection arms.

the grip of your right hand, so that the right thumb engages the slide stop; push the slide fully to the rear and engage the slide stop in the slide stop recess with the right thumb (fig. 31). Resume the position of *raise pistol*, with the slide to the rear. Take the magazine out of the belt and hold it in the open hand at the height of the belt, with the open end of the magazine to the front and the front of the magazine to the left (fig. 32). If the inspecting officer takes the pistol for inspection, lower the right hand smartly to your side as in the position of *attention*. When the inspector is ready to return the pistol, raise the right hand to the *raise pistol* position.

d. Close Chamber. After the pistol has been inspected, or at the command of CLOSE CHAMBER or PORT ARMS, press the slide stop down with the right thumb and let the slide go forward. Pull the trigger and remain at *raise pistol*.

e. Insert Magazine. At the command of INSERT MAGAZINE, without lowering the right hand, turn the barrel slightly to the right. Grasp the magazine with the first two fingers and thumb of the left hand, insert it into the pistol, press the magazine upward until it is engaged by the magazine catch, and resume the position of *raise pistol* (fig. 29).

59. Return Pistol

a. Execute this movement on the command RETURN PISTOL or on the command ORDER (RIGHT SHOULDER) ARMS after INSPECTION ARMS and PORT ARMS have been given.

b. Upon the command of execution, lower the pistol to the shoulder holster, raise the snap fastener of the holster with your right thumb, insert the muzzle of the pistol into the holster, and thrust it home. Button the snap fastener of the holster with the right hand. When wearing a hip holster, at the command RETURN PISTOL, return the pistol to the holster, directly from the position of *raise pistol*.

CHAPTER 4

MARKSMANSHIP TRAINING

Section I. GENERAL

60. Introduction

The primary use of the pistol is to engage an enemy at close range with quick, accurate fire. Accurate shooting is the result of knowing and correctly applying the important elements of marksmanship.

61. Fundamentals of Marksmanship

The important elements of marksmanship are—

- a. Aiming (sight alinement and sight picture).
- b. Positions (grip of the pistol and body positions).
- c. Trigger squeeze.

62. Phases of Training

- a. Marksmanship training is divided into two phases—
 - (1) Preparatory marksmanship training.
 - (2) Range firing.
- b. Each of the two phases may be divided into separate instructional steps. All marksmanship training must be progressive.

Section II. PREPARATORY MARKSMANSHIP TRAINING

63. General

a. A thorough course in preparatory marksmanship training must precede any range firing. This training must be given to all soldiers expected to fire the pistol on the range, including those who have previously qualified with the weapon. The soldier should develop correct shooting habits before range firing. The purpose of preparatory marksmanship training is to establish and correct shooting habits.

b. Preparatory marksmanship training is divided into seven steps which should be taught in the following order:

- (1) Aiming.
- (2) Positions.

- (3) Trigger squeeze.
- (4) Slow fire.
- (5) Rapid fire.
- (6) Quick fire.
- (7) Examination.

64. Coaching

a. Throughout preparatory marksmanship training, the coach-and-pupil method of training should be used. The ultimate proficiency of a pupil depends to a great extent on how well his coach performs his coaching duties. The coach assists the firer by—

- (1) Correcting any errors made.
- (2) Insuring that he takes proper firing positions.
- (3) Insuring that he observes all safety precautions.

b. Duties of the coach during instruction practice and record firing are—

- (1) Check to see that the—
 - (*a*) Pistol is cleared.
 - (*b*) Ammunition is clean.
 - (*c*) Sights are blackened.
 - (*d*) Magazines are clean and operational.
- (2) Observe the firer to see that he—
 - (*a*) Takes the correct firing position.
 - (*b*) Loads the pistol properly and only on command.
 - (*c*) Takes up the trigger slack correctly.
 - (*d*) Squeezes the trigger correctly. The coach cannot tell by watching the trigger finger whether the shooter squeezes or jerks the trigger. The coach must observe the firer for signs that indicate that the firer is anticipating the recoil of the weapon. These signs are general nervousness, fluttering of the eyelids, small muscular spasms around the mouth, nose, and eyes. The most obvious indication of faulty trigger squeeze is the location of the strike of the bullet in relation to the center of the target. It is the coach's duty to observe the firer during the firing and look for these indications and correct them.
 - (*e*) Calls the shot each time he fires. (Except for quick fire and rapid fire.)
 - (*f*) Holds his breath correctly.
 - (*g*) Lowers his pistol and rests his arm when he does not fire a round within 8 or 9 seconds.

- (3) If a firer is tense and nervous, have him breathe deeply several times to relax.
- (4) After each table of fire is completed, inspect the pistol to make sure it is clear. Score the target and record the results.

c. During record firing, coaching is not permitted. No person may render or attempt to render the firer any assistance while he is taking his position or after he has taken his position at the firing point. Each firer must observe the location of his hits and assist the coach in scoring. The coach will manipulate the targets during rapid fire and quick fire exercises. He will also insure that the magazines are loaded with the correct amount of ammunition for each firing table.

65. Aiming

a. Sight alinement or aiming is placing the front and rear sights of the pistol into correct alinement with the eye. For correct sight alinement, the firer must center the front sight in the rear sight and raise or lower the top of the front sight, so that it is level with the top of the rear sight (fig. 33).

b. A sight picture is the pattern of the pistol sights in relation to the target as seen by the firer when he aims the pistol. A correct sight picture consists of correct sight alinement with the bull's-eye centered above and appearing to touch the top of the front sight (fig. 33). When aiming, the eye cannot focus on three objects (rear sight, front sight, bull's-eye) at different ranges. Therefore, the last focus of the eye is always on the front sight. The front and rear sights will be seen clear and sharp while the bull's-eye will appear to be a bit hazy. With correct sight alinement, the strike of the bullet will be in the bull's-eye even if the sight picture is partially off the center but still touches the bull's-eye. Since it is impossible to hold the weapon perfectly still, the shooter must understand that he must apply trigger squeeze (par. 69b) and maintain correct sight alinement while the weapon is moving in and around the bull's-eye. This movement of the weapon is referred to as "wobble area." The shooter must trust this wobble area or movement and make an effort to keep the wobble or movement of the weapon to a minimum.

c. Correct sight alinement is essential for accuracy, particularly with the pistol because of the short sight radius. For example, if a $\frac{1}{10}$ -inch error is made in alining the front sight in the rear sight, the bullet will miss the point of aim by approximately 15 inches at 25 meters of range. The $\frac{1}{10}$ -inch error in sight alinement

magnifies itself as the range increases; at 25 meters it is magnified 150 times.

d. If the firer does not call his shot correctly in range firing, he is not concentrating on sight alinement; consequently, he does not know what his sight picture is as he fires. To call the shot is to state where the bullet should strike the target according to the sight picture at the instant the weapon fires: e.g. "high," "a little low," "to the left," "to the right," or "bull's-eye." Another specific method of calling the shot is the clock system: e.g., 9 o'clock or 2 o'clock.

e. It is important to emphasize that holding the breath properly is necessary to good marksmanship. Emphasis upon this point is required because many men hold their breath improperly or not at all. The breath should be held while the firer is aiming and squeezing the trigger. While the procedure is simple, it requires explanation, demonstration, and supervised practice. To hold the breath properly, the firer inhales an ordinary breath, lets a little out, and holds the rest by closing the throat.

66. Sighting Bar Exercise

This exercise teaches correct sight alinement and the correct sight picture. The M15 sight device may be used in addition to the sighting bar.

a. The instructor displays a sighting bar and points out the front and rear sights, the eyepiece, and the movable target. He explains the following:

- (1) The front and rear sights on the sighting bar represent enlarged pistol sights.
- (2) The sighting bar is used in the first aiming exercise because, by its use, small errors can be detected easily and explained to the pupil.
- (3) Use of the eyepiece requires the pupil to place his eye in such a position that he sees the sights in exactly the same alinement as seen by the coach.
- (4) Although there is no eyepiece on the pistol, the pupil learns by use of the sighting bar how to aline the sights properly when aiming the pistol.
- (5) The movable target attached to the end of the sighting bar provides a simple means for alining the bull's-eye with the sights.

b. The instructor explains how to sight with the sighting bar and shows an example of correct sight alinement (fig. 33).

c. To illustrate correct sight alinement, the instructor, by moving the rear sight, adjusts the sights of the sighting bar, with

the target removed. He requires each student to look through the eyepiece at the correct sight alinement.

d. The instructor then adjusts the sights to show various small errors in sight alinement and requires each man to detect the errors.

e. The instructor describes a correct sight picture, showing an illustration to each man (fig. 33). He explains that the front sight is seen through the center of the rear sight in such a manner that its top is level with the top of the rear sight and just touches the bottom of the bull's-eye. All of the bull's-eye can be seen.

f. The instructor adjusts the sights of the sighting bar and the movable target to illustrate a correct sight picture. Each man looks through the eyepiece to observe the correct sight picture.

g. The instructor adjusts the sights and the movable target of the sighting bar to illustrate various small errors. Each man attempts to detect and describe them.

h. After completing the above exercise, coaches and pupils are designated, and the exercise is repeated as time permits.

67. Positions

a. *General.* To assume the proper position for firing, it is necessary to know the correct position of the body with relation

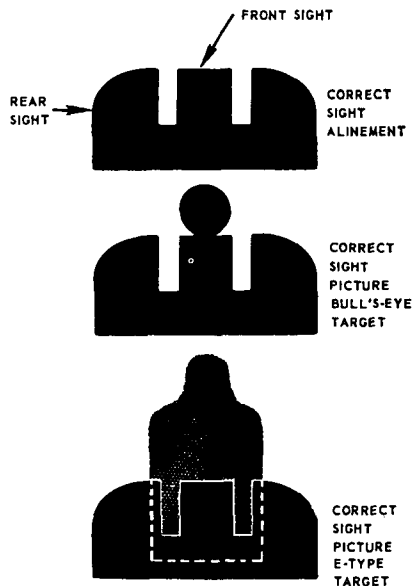

Figure 33. Correct sight alinement and sight picture.

to the target and how to grip the pistol correctly. The qualification course is fired from the standing, kneeling, crouch, and prone positions. The appropriate positions outlined and illustrated in this paragraph or similar positions contained in paragraph 136 may be used. The one-hand grip is used for firing from the standing position. The two-hand grip is used for firing from the prone and kneeling positions.

b. One-Hand Grip. The most important feature of the grip is uniformity. For tight shot groups, the grip must be the same each time a shot is fired.

- (1) To obtain the correct grip, pick up the pistol and place it in the firing hand until the grip safety is pressed into the Y formed between the thumb and forefinger of the firing hand. The hand should be as high as possible on the receiver without having the flesh squeezed between the hammer and the grip safety.
- (2) Grip the receiver firmly with the hand and fingers. It is important to maintain the same degree of firmness throughout the firing, because a change in the firmness and position of the grip will change the location of the shot group on the target. A tight grip will cause the strike of the bullet to be low on the target, and a loose grip will cause the shot to hit high on the target. Therefore, a firm grip throughout the course of fire is essential. To obtain a firm grip, the pistol is placed into the Y formed by the thumb and forefinger with the main spring housing resting firmly in the palm of the hand. The lower three fingers are then wrapped around the grip with the index finger resting comfortably under the trigger guard. The thumb is held up and along the left side of the pistol with enough pressure to steady the pistol and to equalize any pressure being exerted on the right side of the pistol by the palm and forefinger.
- (3) Place the trigger finger inside the trigger guard so that the finger will engage the front surface of the trigger (fig. 35). The position of the trigger finger on the trigger will differ among firers; however, the closer to the second joint of the finger to the point of contact with the trigger, the more leverage you can apply to the trigger. Care should be exercised so that the trigger finger does not touch either side of the receiver. Many shooters use the first joint or tip of the finger. This area will afford more sensitivity but less leverage. With the heavy

trigger pull (5 to 6½ lb.) on the service pistol, advantage is gained by using the best leverage and control of the trigger. Each shooter should experiment with the placement of the trigger finger to ascertain which position of the trigger finger gives the best control. The pressure of the trigger finger is straight to the rear, with increasing pressure to cause the weapon to fire.

c. Two-Hand Grip. The two-hand grip is used for firing from the prone or kneeling position. It allows the firer to support the one-hand grip thereby attaining more accuracy. The two-hand grip is obtained as follows: Grip the pistol as prescribed in *b* above; then firmly close the fingers and thumb of the free hand over the firing hand in a manner that will provide maximum support (fig. 34).

d. Standing Position. To assume the standing position, the firer faces his target, then faces slightly more than 45 degrees left or right. The feet are spread 12 to 18 inches apart, and the weight of the body is balanced equally on both feet. The legs are straight without stiffness and the hips level. The stance is adjusted so that his firing arm points naturally at the target (fig. 35). After he assumes this position, the firer picks up the pistol with his free hand and takes the one-hand grip as prescribed in *b* above. When the proper grip is taken, the muscles of the arm are firm without being rigid. The pistol slide is a direct prolongation of the firing



Figure 34. The two-hand grip.



Figure 35. Standing position.

arm, and the wrist is locked so that the weapon cannot search up or down. The elbow is straight and locked. The only pivot during recoil is that of the shoulder joint. After recoil, when the firer is in the correct position, the pistol arm will return to approximate alinement with the target. Due to differences of body conformation of individuals the standing position may vary slightly, but regardless of body conformation, the position assumed should be

relaxed and comfortable. The pistol, held in the firing position, should point naturally and without undue effort at the center of the target. Unless the body, the pistol, and the target are in correct alinement, the firer will be tense while aiming and firing each shot. Muscular tension, in turn, causes trembling, excessive fatigue, and movement of sights in the target area. If this occurs, the entire body must be moved by shifting the feet until the pistol, held in the firing position, points toward the center of the target. The position of the body in the standing position is the same for firing the revolver.

e. Prone Position. The prone position is used by the soldier to obtain maximum stability when firing at 25-meter targets and at longer ranges. This position will be used often in combat as it makes a firer a smaller target and makes for maximum accuracy. To assume the prone position, the firer drops to his knees and falls forward, breaking his fall with his free hand. He lies flat on the ground with legs apart, heels down. The head and body are on a line with the target. The arms are extended with the pistol held in the two-hand grip (fig. 36).

Caution: The arms must be extended far enough to prevent the slide from striking the firer in the face during recoil. This precaution also applies in the kneeling position.

f. Kneeling Position. The kneeling position is used to obtain increased accuracy, in rapid fire, at longer ranges. To assume the kneeling position, the firer kneels on the right knee and rests his left upper arm on the raised left knee (which is pointed toward

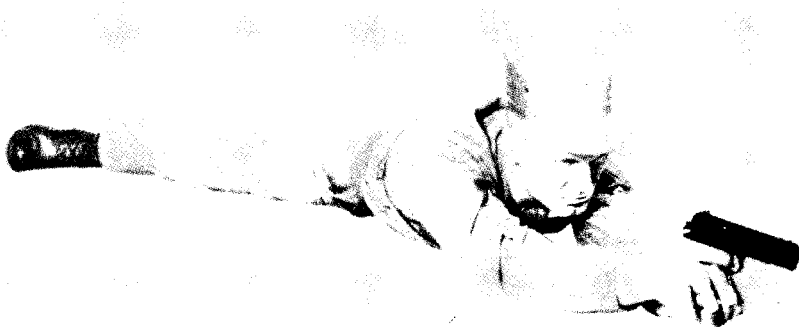

Figure 36. The prone position; two-hand grip.

the target), with the elbow projecting beyond the knee to give support. The weight of the body is distributed on the calf of the right leg and heel of the right foot. The receiver of the pistol, held in the one-hand grip, is then seated on the palm of the left hand and the two-hand grip is used (fig. 37). Men who shoot left-handed will reverse the position.

g. Crouch Position, Point Fire. The crouch position is used when surprise targets are engaged at close range. The body is in a forward crouch (boxer's stance) with the knees bent slightly and trunk bent forward from the hips. The feet are placed naturally in a position that will allow another step toward the target. At all times, the body should be maintained in a balanced position, facilitating rapid movement in any direction. The pistol is



Figure 37. Kneeling position; two-hand grip.

extended straight toward the target, and the wrist and elbow of the firing arm are locked (fig. 62).

h. Pistol Ready Position. In the pistol ready position, the pistol is held in the one-hand grip. The upper arm is held close to the body, and the forearm is in a horizontal position. The pistol is pointed toward the target area as the firer moves forward.

68. Position Exercises

a. First Exercise (Standing Position).

Note. Required for this exercise area line of 25-yard pistol targets (standard American) and firing points at 15 and 25 meters.

- (1) The instructor places the men, armed with the pistol, on line at 1-pace intervals. He gives the command INSPECTION ARMS and verifies that all pistols are clear.
- (2) He demonstrates the position of the hand in gripping the pistol and describes the grip in detail.
- (3) He demonstrates the correct standing position.
- (4) He requires each firer to hold his pistol in the one-hand grip and to assume the correct standing position. Assistant instructors correct all errors.
- (5) The instructor then places the men in pairs on the 15-meter firing points facing the 25-yard pistol targets, and instructs them in coaching each other as follows:
 - (a) Grasp the pistol with the correct grip.
 - (b) Face the target, then face slightly more than half left (right).
 - (c) Place the feet 12 to 18 inches apart.
 - (d) Aline the sights on the bottom edge of the bull's-eye, arm extended.
 - (e) As the arm becomes tired or the aim becomes unsteady, assume the position of *raise pistol*. Remove the pistol from the firing hand and relax, and then exercise the muscles of the hand, arm, and shoulder before resuming the grip.
 - (f) Keep the hammer forward during the position exercise and squeeze the trigger very lightly with the finger.

Note. Coaches observe and correct all errors.

- (g) Pupil and coach change over (as the instructor directs—every 3 to 5 minutes).

Note. Only short periods should be devoted to this position exercise.

b. Second Exercise (Prone Position).

Note. Required for this exercise are a line of silhouette targets (E targets), and firing points at 25 meters.

- (1) The instructor places the men, armed with the pistol, on line at 2-pace intervals. He gives the command INSPECTION ARMS and verifies that all pistols are clear.
- (2) He explains and demonstrates the two-hand grip.
- (3) He explains and demonstrates the prone position and explains in detail the method of assuming the position.
- (4) He requires each man to apply the two-hand grip until it is understood .
- (5) He requires each man to assume the prone position. Assistant instructors and coaches correct all errors.
- (6) The instructor then pairs the men as coach and pupil, places them in position 25 meters from their targets, and instructs them to take turns coaching each other as follows:
 - (a) Hold the pistol at the ready position.
 - (b) Face the target and move into the prone position.
 - (c) Grasp the pistol in the two-hand grip.
 - (d) Aim at the center of mass of the target with correct sight alinement.
 - (e) As soon as the arms become tired or the aim unsteady, rise to the knees, return the pistol to the ready position, and stand up. To rest the firing hand, transfer the pistol to the free hand.
 - (f) Keep the hammer forward during the position exercise and squeeze the trigger lightly with the finger.
 - (g) After a short rest, repeat the exercise.

Note. Coaches observe and correct all errors.

- (h) Coach and pupil change over (as the instructor directs—this should be every 3 to 5 minutes).

c. Third Exercise (Kneeling Position). Procedures are the same as listed in the second exercise (*b* above), except that the kneeling position is substituted for the prone position.

d. Fourth Exercise (Crouch Position).

Note. Required for this exercise are a line of E targets and firing points at 10 meters.

- (1) The instructor explains and demonstrates the crouch position and the pistol ready position.

(2) He pairs the men as coach and pupil, places them in position 2 paces apart on the 10-meter line, facing their targets, and instructs them to take turns coaching each other as follows:

- (a) Grasp the pistol using the one-hand grip.
- (b) Hold the pistol at the ready position.
- (c) Face the target and assume the crouch standing position.
- (d) Aline the pistol on the target by thrusting it forward as if pointing a finger at the target. Direct the eyes at the target only. Lock the wrist and elbow; the only pivot is the shoulder.
- (e) Check the alinement by holding the pistol in position and looking to see if the sights are alined on the target.

Note. Remainder of the exercise is the same as in *a*(5) (*f*) and (*g*) above.

69. Trigger Squeeze

a. General. Poor shooting is generally caused by the aim being disturbed before the bullet leaves the barrel of the pistol. This is usually the result of the firer jerking the trigger or flinching. The trigger does not have to be jerked violently to spoil the aim; even a slight off-center pressure of the trigger finger on the trigger is enough to cause the pistol to move and disturb the firer's sight alinement. Flinching is a subconscious reflex caused by the firer's anticipating the recoil of the weapon. Jerking is an effort by the firer to fire the pistol at the precise time the sights aline with the target. Flinching and jerking will cause the strike of the bullet to hit the lower left section of the target for a right-hand shooter. Heeling is caused by a firer's tightening the large muscle in the heel of the hand to keep from jerking the trigger. A firer who has had difficulty with jerking the trigger will attempt to correct the fault by tightening the bottom of the hand, which results in a heeled shot. Heeling will cause the strike of the bullet to hit on the top right section of the target. The firer can correct all these shooting errors by understanding and applying correct trigger squeeze. Correctly applied trigger squeeze imparts no unnecessary movement to the pistol. Improper trigger squeeze will cause more misses on the target than any other single step of preparatory marksmanship training.

b. Definition of Trigger Squeeze. Trigger squeeze may be defined as the independent movement of the trigger finger applying a uniformly increasing pressure on the trigger, straight to

the rear, without disturbing the sight alinement until the pistol fires. The trigger slack, or free play, is taken up first and the squeeze is continued steadily until the hammer falls. If the trigger is squeezed properly, the firer will not know when the hammer will fall; thus, he will not know when to flinch or heel. To apply correct trigger squeeze, the trigger finger may contact the trigger anywhere from the tip to the second joint, depending on the length of the trigger finger. If pressure from the trigger finger is applied to the right side of the trigger or pistol, the strike of the bullet will be to the left. This is due to the normal hinge action of the fingers. When the fingers of the right are closed, as in gripping, they hinge or pivot to the left, thereby applying pressure to the left. (With the left hand, this action is to the right.) The firer must exercise care in the squeeze of the trigger, so as not to apply pressure left or right but straight to the rear. The method of trigger squeeze used by the firer will determine his marksmanship ability as follows:

- (1) The man who has learned to apply pressure on the trigger only when the sights are in alinement with the target, who holds the pressure if the muzzle swerves, and continues to add pressure when the sights are again in line with the target is an *excellent shot*.
- (2) The man who holds the sights of the pistol as nearly on the target as possible and continues to squeeze the trigger with a uniformly increasing pressure until the pistol fires, is a *good shot*.
- (3) The man who tries to "catch his target" as his sight alinement moves past the target, and fires the pistol at that instant, is a very *bad shot*.

c. *Calling Shot*. To call the shot is to state where the bullet should strike the target according to the sight picture at the instant the pistol fires; for example: "high," "a little low," "to the left," "to the right," or "bull's-eye." Another specific method of calling the shot is the clock system; for example: a 9 ring hit at 8 o'clock, and 8 ring hit at 3 o'clock. Another good method of calling a shot is to provide the shooters with a target center. (Placed beside him on the firing line) and as soon as the shot is fired the shooter is required to place a finger on the target face or center at the point where he expected the round to hit on the target. This method eliminates guessing and computation on the part of the shooter, and the immediate action of placing the finger on the target face will give a more accurate call. If the soldier does not call his shots correctly in range firing, he is not properly concentrating on sight alinement and trigger squeeze, and con-

sequently does not know what his sight picture is as the weapon fires.

70. Pencil Triangulation Exercise

This exercise consists of firing a pencil or pointed dowel point-blank at a miniature target. This exercise combines position, grip, sight alinement, breathing, and trigger squeeze into a single practical work exercise and at the same time measures the student's performance without the effects of recoil. This practical work is designed to teach and develop correct shooting habits, and can be conducted indoors as well as outdoors. This makes it an ideal type of practical exercise where range facilities are limited or during inclement weather.

a. Equipment. In the conduct of this exercise the following equipment is necessary:

- (1) One dowel or lead pencil per two students. (This pencil should be at least 6 inches long and wrapped with masking or cellophane tape, forming two bushings that fit the inside diameter of the pistol barrel (fig. 38).
- (2) One sheet of miniature bull's-eyes per two students. (This sheet of bull's-eyes, as shown in figure 38, can be mimeographed, drawn, or stamped by using the eraser of a pencil and ink pad. The bull's-eyes should not be larger than $\frac{1}{8}$ inch and at least 1 inch apart.)

b. Conduct of the Exercise. The instructor explains and demonstrates the details of this exercise, prior to practical work by the students, in the following manner:

- (1) The shooter faces the target and takes up a good shooting position. (This position is close enough to the miniature bull's-eye so that when the pencil is inserted into the barrel, with the arm extended and sights aimed at the miniature bull's-eye, the point of the pencil is within 1 inch of the target. The sheet of bull's-eyes should be affixed to a target or any type support and should be shoulder high to the shooter.)
- (2) The shooter inserts the pencil into the muzzle of the barrel, eraser end first, and cocks the hammer.
- (3) He grips the weapon properly, extends the shooting arm and aims the weapon at the miniature bull's-eye, squeezes the trigger and the hammer falls. The hammer strikes the firing pin, which in turn strikes the rubber eraser of the pencil, driving it out of the barrel and causing it to make a pencil dot approximately $\frac{1}{2}$ inch

below the bull's-eye (assuming that the shooter had the correct sight alinement and trigger squeeze).

- (4) The shooter continues this exercise until he has fired a group of five pencil marks below each target. (The object of the exercise is to keep the five pencil marks in a group as small as the $\frac{1}{8}$ -inch bull's-eye, $\frac{1}{2}$ inch directly below the bull's-eye.) With practice, many shooters will be able to keep the pencil hitting in the same mark. This is an indication that the shooter is performing trigger squeeze and sight alinement properly each time.
- (5) The coach should observe and be alert to detect any errors the shooter may be making. Upon completion of the firing, the coach will critique the shooter on his shot groups. (The coach will be able to tell whether or not the shooter jerks or heels the shots by observing the mark of the pencil in relation to the bull's-eye and the shot group.) This exercise should be repeated until the shooter is able to make a five-round shot group $\frac{1}{8}$ inch or smaller. Men who are not able to attain this proficiency need additional instruction including trigger squeeze and sight alinement.

71. Slow Fire

a. Slow fire teaches the firer to coordinate and apply the first three steps of preparatory marksmanship; aiming, positions, and trigger squeeze. It is the elementary phase of instruction practice and record firing. Time must be taken to permit proper explanation of the causes of errors that are determined and to allow time for correcting these errors during instruction practice firing.

b. Training for slow fire is begun after the trigger squeeze exercises are thoroughly understood and can be applied. The slow fire exercise is a continuation of the trigger squeeze exercises and is conducted in the same manner with the same equipment. However, greater emphasis is placed on coordination of aiming, position, and trigger squeeze rather than on each of these steps individually. The slow fire exercise simulates slow fire in range firing. The pistol is cocked with the thumb of the free hand after each simulated shot.

72. Slow Fire Exercise

a. To perform the slow fire exercise, the firer assumes the standing position with the pistol pointed at the target. He takes

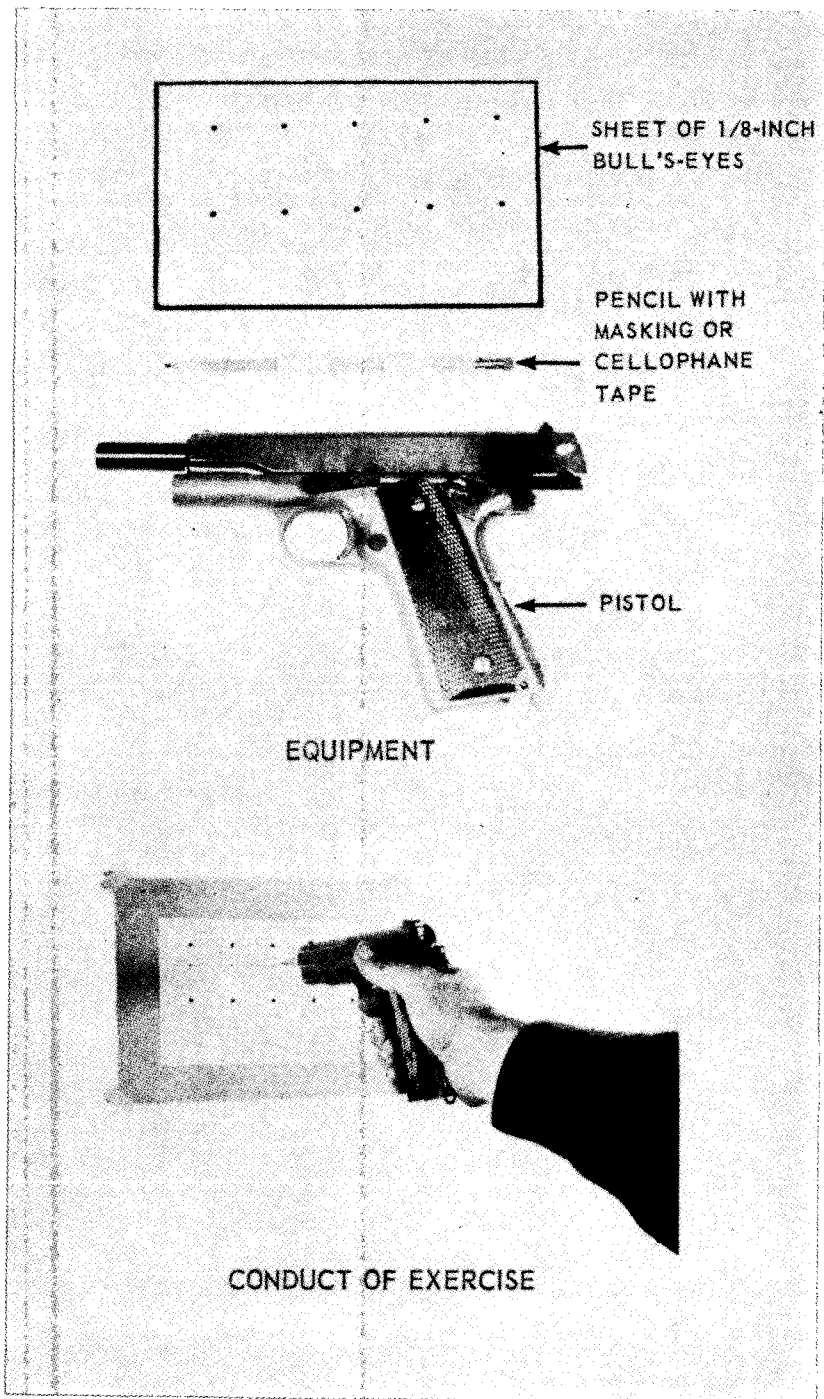

Figure 38. Pencil triangulation exercise.

in a normal breath and lets part of it out, locking the remainder in his lungs by closing his throat. He then relaxes, aims at the target, takes the correct sight alinement and sight picture, takes up the trigger slack, and squeezes the trigger straight to the rear with a steadily increasing pressure until the hammer falls, simulating firing. If the firer does not cause the hammer to fall in 8 or 9 seconds, he should come to position of *raise pistol* and rest his arm and hand, then start the procedure over again. The sequence of actions that make up this process can be summed up by the key word BRASS. It is a word the firer should think of every time he fires his weapon:

Breathe—take a normal breath, let part of it out, and lock the remainder in by closing the throat.

Relax—relax the body muscles as much as possible.

Aim—take correct sight alinement and sight picture and focus the eye at the top of the front sight.

Slack—take up the trigger slack.

Squeeze—squeeze the trigger straight to the rear with a steadily increasing pressure without disturbing the sight alinement until the hammer falls.

b. The pencil triangulation exercise may also be used for slow fire practice.

73. Rapid Fire

a. Rapid fire is a series of aimed shots fired at regular, short intervals. Accuracy in rapid fire, as in slow fire, requires a steady aim, good position, and proper trigger squeeze. These three elements are blended together by a high degree of coordination with a minimum loss of time between shots. The firer must be trained in rapid fire to develop his ability to fire rapidly and accurately, so that he can take maximum advantage in combat of the firepower of the pistol if confronted by more than one enemy soldier at close range.

b. The time limit for firing rapid fire is 5 shots in 12 seconds from the 25-meter line. Rapid fire is fired from the prone and kneeling positions using the two-hand grip. There are two rapid fire exercises for training the soldier. The first exercise teaches him to simulate firing 5 shots from the prone position in the prescribed time limit of 12 seconds. The second rapid fire exercise is the same as the first, except that the kneeling position is used.

74. Rapid Fire Exercises

a. First Exercise.

Note. Required for this exercise are a row of E targets spaced in groups of 3, firing points 25 meters away, and a piece of strong cord about 4 feet long for each firer.

- (1) The instructor explains and demonstrates the prone position and states that the firer is in position and completes the exercise in 12 seconds.

Note. Rapid fire exercises should begin by establishing a longer time limit and reducing it until the soldier can complete the exercise in 12 seconds.

- (2) The instructor explains and demonstrates to the students—
 - (a) Tying the cord to the hammer of the pistol.
 - (b) Trigger squeeze—the same in rapid fire as in slow fire except that it is accomplished in a shorter length of time.
 - (c) Loading the pistol—accomplished while in the prone position.
 - (d) The prone position.
 - (e) The sight picture—taken on the center of mass of the E target.
 - (f) The aim—shifted from one target to the other by shifting the body rather than just the arms.
 - (g) The action of the pistol in recoil—pulling on the cord to cock the pistol for each shot.
 - (h) Keeping the eyes from closing as the weapon fires.
 - (i) Holding the breath for the five-shot string.
- (3) The instructor places the men in pairs in front of the line of targets, one as coach and the other as the firer.
 - (a) If a line of disappearing targets has been arranged for this exercise, the instructor conducts the simulated firing with the commands:
 1. FIVE ROUNDS.
 2. SIMULATE LOAD AND LOCK.
 3. READY ON THE RIGHT.
 4. READY ON THE LEFT.
 5. READY ON THE FIRING LINE.

The targets are faced to the firer, allowed to remain facing him for the allotted time, and then edged. While the targets are facing the firer, he fires five

shots (simulated fire), and the coach cocks the pistol by jerking the cord after each shot. At the end of the rapid fire sequence, the targets disappear and the instructor commands UNLOAD.

(b) If the targets for the exercises are stationary, the commands are—

1. FIVE ROUNDS.
2. SIMULATE LOAD AND LOCK.
3. READY ON THE RIGHT.
4. READY ON THE LEFT.
5. READY ON THE FIRING LINE.
6. TARGETS.

On command TARGETS, the firers commence firing five rounds (simulated fire). The coach cocks the pistol after each shot by jerking the cord. When the time has expired, the commands to stop firing are (1) CEASE FIRING, (2) UNLOAD.

(c) After performing the rapid fire exercise three or four times, the coaches and pupils change over.

(4) In this exercise, the instructor makes sure that the coach notes and corrects all errors in grip, position, trigger squeeze, and holding the breath. He gives particular attention to trigger squeeze.

Note. Rapid fire exercises should be frequent but of short duration.

It is advisable to extend the time limits several seconds when the rapid fire exercise is first begun. The time limit is then gradually reduced until it corresponds to the time prescribed for record firing.

Caution: The firer should be warned to make sure that his arms are extended forward to prevent the slide from striking his face while in the prone and kneeling positions.

b. Second Exercise. This exercise is conducted in the same manner using the same equipment as in the first exercise except that the kneeling position is used.

75. Quick Fire

a. Training in quick fire is begun after the rapid fire exercise has been practiced enough to be thoroughly understood. Exercises in slow fire, rapid fire, and quick fire should be continued until the period preparatory marksmanship training is completed.

b. In quick fire, the prone, kneeling, and crouch positions are used.

76. Quick Fire Exercise

Note. Required for this exercise are a row of E targets spaced in groups of 3, and firing lines at 25 meters, 15 meters, and 10 meters.

a. The instructor explains and demonstrates the standing to prone, kneeling, crouch, and ready positions. He explains the conduct of the exercise as follows:

- (1) The firer begins the exercise approximately 35 meters from the targets. The instructor commands—
 - (a) FOUR ROUNDS.
 - (b) SIMULATE LOAD AND LOCK.
 - (c) READY ON THE RIGHT.
 - (d) READY ON THE LEFT.
 - (e) PISTOL AT READY POSITION, FORWARD, MARCH.
- (2) At this command, the firer moves forward, holding the pistol at the ready position, and continues to walk until the command TARGETS is given. (If a line of disappearing targets has been arranged for the exercise, the firer will continue to walk until the target is faced toward him.)
- (3) At the command TARGETS, the firer takes the prone position, moves the safety lock to the FIRE position, and simulates firing at the targets, engaging each target with at least one shot. The command TARGETS is given when the firer is at the 25-meter line. The targets are exposed for 15 seconds.
- (4) The instructor then commands—
 - (a) UNLOAD.
 - (b) RISE.
 - (c) SIX ROUNDS.
 - (d) SIMULATE LOAD AND LOCK.
 - (e) READY ON THE RIGHT.
 - (f) READY ON THE LEFT.
 - (g) PISTOL AT READY POSITION, FORWARD, MARCH.
- (5) At this command, the firer moves forward, holding the pistol at the ready position on SAFE, and continues to walk until the command TARGETS is given. (If a line

of disappearing targets have been arranged for the exercise, the firer will continue to walk until the target is faced toward him.)

- (6) At the command TARGETS, the firer takes the kneeling position, moves the safety lock to the FIRE position, and fires 4 rounds at the targets, engaging each target with at least 1 shot. The command TARGETS is given when the firer is at the 15-meter line. The targets are exposed for 15 seconds.
- (7) The instructor then commands—
 - (a) CEASE FIRING.
 - (b) LOCK.
 - (c) RISE.
 - (d) PISTOL AT THE READY POSITION, FORWARD, MARCH.
- (8) At this command, the firer moves forward, holding the pistol at the ready position on SAFE, and continues to walk until the command TARGETS is given. (If a line of disappearing targets have been arranged for the exercise, the firer will continue to walk until the target is faced toward him.)
- (9) At the command TARGETS, the firer moves into the crouch position, presses the safety lock to the FIRE position, and fires two rounds at separate targets. The command TARGETS is given when the firer is at the 10-meter line. The targets are exposed for six seconds.
- (10) The instructor then commands—
 - (a) CEASE FIRING.
 - (b) UNLOAD.

b. The quick fire exercise should be practiced until the firer can assume the correct firing position, aim, and simulate firing the required number of rounds in the specified time limits.

77. Examination Before Range Firing

a. Each soldier will be examined before he fires the pistol on the range. This examination will detect any deficiencies in his preparatory marksmanship training. The examination must be given far enough in advance so that additional training may be scheduled to correct the deficiencies noted. The examination may be conducted concurrently with the steps of preparatory marksmanship by the use of oral or written questions and answers. It should also be given immediately after completing the six steps

of preparatory marksmanship training as a single, performance-type test.

b. The performance-type test, given at the completion of preparatory marksmanship training, is commonly called the "county fair." It is made up of a number of stations to test the men on marksmanship training. The men to be tested are divided into groups and rotated through each of the stations. A minimum number of trained assistant instructors in a minimum of time can test a large number of men by using the county fair system.

c. In the conduct of the examination, the men are broken down into groups, one group for each station. Each group is sent to a station and the test begins. Upon completion of testing at the first station of each group and upon the instructor's command, the groups move in a clockwise direction to the next station. The testing procedure is repeated until each group has been tested at each station. Grading sheets are reproduced locally, and the assistant instructors grade each man as he performs the various examination requirements.

d. Examples of how the county-fair type of examination may be conducted at each station are discussed below.

- (1) *Station 1, aiming.* Each man is required to demonstrate his ability to set up correct sight alinement and a correct sight picture on the aiming bar.
- (2) *Station 2, aiming.* Each man is required to make a shot group using the pencil triangulation exercise.
- (3) *Station 3, positions.* The men demonstrate their ability to assume the various positions (standing, crouch, kneeling, and prone).
- (4) *Station 4, trigger squeeze.*
- (5) *Station 5, rapid fire.* The men perform one of the rapid fire exercises and the assistant instructor grades them on the correct procedures and timing.
- (6) *Station 6, quick fire.* The men perform a portion of the quick fire exercise and are graded on procedure and timing.
- (7) *Station 7, load, immediate action, unload.*
- (8) *Station 8, testing the grip safety, safety lock, disconnector, and half cock.*

e. Other stations may be set up to test different items of instruction. The items listed above are for use as an instructor's guide.

Section III. COURSES FIRED

78. General

a. AR 370-5 prescribes details as to the requirements for firing of record and familiarization courses.

b. Range firing is started after the soldier satisfactorily completes preparatory marksmanship training. Range firing courses are—

- (1) Instruction practice firing, which is practice firing on a range using the assistance of a coach.
- (2) Record firing, which is the final test of the soldier's proficiency, and is the basis for his marksmanship classification.
- (3) Familiarization firing, which acquaints the soldier with the weapon. It is fired only by soldiers who are not required to fire the record course for qualification.
- (4) Specialized firing (par. 88) which is for use by specially qualified and selected individuals whose military duties demand special ability with hand guns. This course is not to be used for mass training of all individuals armed with the pistol or revolver.

c. The amount of instruction practice firing is not limited to that prescribed. Additional practice may be given as time and ammunition allowances permit.

d. Scores of instruction practice and record firing done with the pistol should be entered on the score card to enable the firer to maintain a record of his progress and scores.

79. Instruction Practice Firing Course

The following tables prescribe the instruction practice to be fired from the standing, prone, kneeling, and crouch positions. The E target and the 25-yard (standard American) pistol target are used in the practice firing.

Table I. Slow Fire (25-yard standard American pistol target (fig. 42))

Range (meters)	Position	Time	Shots
15	Standing	None (10 min in record firing)	10
25	Standing	None (10 min in record firing)	10

Table II. Rapid Fire (E target, bobbing (3) (fig. 41))

Range (meters)	Position	Time	Shots
25	Prone	12 seconds	5
25	Kneeling	12 seconds	5

Table III. Quick Fire (E target, bobbing (3) (fig. 41))

Range (meters)	Position	Time	Shots
25	Standing to prone	15 seconds	4
15	Standing to kneeling	15 seconds	4
10	Crouch	6 seconds	2

80. Record Firing Course

a. Tables I, II, and III used in instruction practice firing (par. 79) are fired for record in numerical order. Procedures to be followed for the conduct of the range and scoring are outlined in paragraphs 83 through 89.

b. Coaching is not permitted during record firing.

c. Qualification scores, of a total possible score of 400, are as follows:

Expert	-----	350
Sharpshooter	-----	330
Marksman	-----	300

d. Record of scores should be entered on each individual's score card. A correctly filled-in sample score card is shown in figure 39.

81. Familiarization Firing

a. All persons authorized or required to fire the pistol for familiarization will receive four hours of preliminary instruction, which will include the following:

- (1) Mechanical training: disassembly and assembly.
- (2) Operation: loading, firing, unloading, immediate action.
- (3) Preparatory marksmanship training: aiming, positions, trigger squeeze.
- (4) Care and cleaning.

b. Table IV is the prescribed familiarization exercise.

INDIVIDUAL SCORE CARD				DATE			
CALIBER: .45 PISTOL AND CALIBER .38 REVOLVER RECORD FIRING (FM 21-35)				10 May 60			
LAST NAME - FIRST NAME - MIDDLE INITIAL				GRADE			
WHITE, JOHN B.				PFC			
ORGANIZATION							
COA, 4/34 ARMOR							
TABLE I - SLOW FIRE (Possible: 200)							
RANGE (Meters)	POSITION	TIME LIMIT	SCORE				
15	Standing	10 shots in 10 minutes	10	10	10	9	9
			9	8	6	6	5
25	Standing	10 shots in 10 minutes	10	10	9	9	9
			8	8	7	7	7
TOTAL			166				
TABLE II - RAPID FIRE (Possible: 100)							
RANGE (Meters)	POSITION	TIME LIMIT	SCORE				
25	Prone	5 shots in 12 seconds	10	10	10	10	10
			TOTAL				
25	Kneeling	5 shots in 12 seconds	10	10	10	10	10
			TOTAL				
TABLE III - QUICK FIRE (Possible: 100)							
RANGE (Meters)	POSITION	TIME LIMIT	SCORE				
25	Standing to prone	4 shots in 15 seconds	10	10	10	10	
			TOTAL				
15	Standing to kneeling	4 shots in 15 seconds	10	10	10	10	
			TOTAL				
10	Crouch	2 shots in 6 seconds	10	10			
			TOTAL				
TOTAL RECORD SCORE			366				
POSSIBLE SCORE: 400		SCORER'S SIGNATURE					
EXPERT - 350		FIREN'S SIGNATURE					
SHARPSHOOTER - 310		SIGNATURE OF OFFICER					
MARKSMAN - 200							

DA FORM 88 1 JUN 60 88 PREVIOUS EDITIONS OF THIS FORM ARE OBSOLETE.
(Front)

INSTRUCTION PRACTICE FIRING							
TABLE I - SLOW FIRE (Possible: 200)							
RANGE (Meters)	POSITION	TIME LIMIT	SCORE				
15	Standing	10 shots No Time Limit	10	10	9	9	9
			9	8	8	6	6
25	Standing	10 shots No Time Limit	10	9	9	8	8
			8	8	7	5	5
TOTAL			161				
TABLE II - RAPID FIRE (Possible: 100)							
RANGE (Meters)	POSITION	TIME LIMIT	SCORE				
25	Prone	5 shots in 12 seconds	10	10	10	10	10
			TOTAL				
25	Kneeling	5 shots in 12 seconds	10	10	10	10	10
			TOTAL				
TABLE III - QUICK FIRE (Possible: 100)							
RANGE (Meters)	POSITION	TIME LIMIT	SCORE				
25	Standing to prone	4 shots in 15 seconds	10	10	10	0	
			TOTAL				
15	Standing to kneeling	4 shots in 15 seconds	10	10	10	10	
			TOTAL				
10	Crouch	2 shots in 6 seconds	10	10			
			TOTAL				
TOTAL PRACTICE SCORE			351				

(Back)

Figure 39. Score card.

Table IV. Familiarization Firing (E target, bobbing (3) (fig. 41))

Range (meters)	Position	Time	Shots
15	Standing	No time limit	10
25	Standing	3 seconds per shot	15

82. Specialized Firing

The procedures for organizing and conducting this course are covered in paragraph 88.

Section IV. RANGE FIRING AND SAFETY PRECAUTIONS

83. Responsibility

Organization commanders are responsible for the conduct of range firing of their organizations in accordance with the provisions of this manual and applicable Army Regulations. All range firing will be conducted under the direct supervision of a commissioned officer.

84. Blackening Sights

In all range firing, both sights of the weapon should be blackened to eliminate glare and to silhouette the sights distinctly. Before being blackened, the sights should be cleaned and all traces of oil removed. The blackening is done by holding each sight for a few seconds in the point of a small flame that will deposit a uniform coating of lampblack on the metal. A carbide lamp, candle, or other flame device may be used for this purpose. Flame from a carbide lamp is the most satisfactory.

85. Procedure for Organizing and Conducting Instruction Practice Firing

a. Table I—Slow Fire.

- (1) The officer in charge (OIC) of the range organizes the men into alternate orders, designated firers and coaches. Each order of firers is matched with an order of coaches. One firer with coach is assigned to each firing point on the 15-meter firing line.
- (2) One 25-yard (standard American) pistol target and a group of three E targets are installed in front of each firing point.
- (3) The OIC commands **LOAD TWO MAGAZINES WITH FIVE ROUNDS EACH**. At this command, the coach loads each magazine with five rounds of ball ammunition. (He may space one or two dummy cartridges in the magazine to aid in determining whether the firer is squeezing the trigger properly or flinching.)
- (4) The OIC commands:
 - (a) **SLOW FIRE (10-MINUTE TIME LIMIT—Record firing; no time limit in instruction practice).**
 - (b) **FIVE ROUNDS.**
 - (c) **LOAD AND LOCK.**
 - (d) **READY ON THE RIGHT.**
 - (e) **READY ON THE LEFT.**

- (f) READY ON THE FIRING LINE.
- (g) COMMENCE FIRING.
- (5) As the firer completes the firing of these 5 rounds, he will reload the pistol with another 5 and continue to fire until all 10 rounds are fired or the time limit expires. He will place the pistol on the stand, then step approximately 2 paces to the rear of the firing line, indicating to the OIC that he has completed the firing.
- (6) When time has expired, or when the firers have finished the exercise, the OIC commands:
 - (a) CEASE FIRING.
 - (b) UNLOAD.
 - (c) CLEAR ON THE RIGHT.
 - (d) CLEAR ON THE LEFT.
- (7) The OIC looks to the right and left of the firing line at the safety officer or safety noncommissioned officers to determine that the firing line is clear. When the firing line is clear, he commands:
 - (a) THE FIRING LINE IS CLEAR.
 - (b) FIRERS AND COACHES MOVE FORWARD.
 - (c) SCORE AND PASTE TARGETS (par. 86b(2) and (7)).
- (8) The above sequence is used in firing the 10 rounds in slow fire from the 25-meter line.
- (9) The other assigned order fires slow fire from the 15-meter line. The pistol stands are moved back to the 25-meter line, where the firing orders will complete the firing of table I.

b. *Table II—Rapid Fire.*

- (1) The OIC assigns one firer to each firing point at the 25-meter line and has the coach load 2 magazines each with 5 rounds of ball ammunition.
- (2) The OIC commands—
 - (a) RAPID FIRE, 12-SECOND TIME LIMIT.
 - (b) FIRERS ASSUME THE PRONE POSITION.
 - (c) FIVE ROUNDS.
 - (d) LOAD AND LOCK.
 - (e) READY ON THE RIGHT.
 - (f) READY ON THE LEFT.

If a firer is not ready, he will announce to the OIC, NOT READY ON POINT NUMBER _____. When

everyone is ready, the fire command is continued:
READY ON THE FIRING LINE.

- (3) The targets are then faced toward the firer for 12 seconds, then edged. The firer fires 5 rounds, engaging each of the 3 targets during this exercise.
- (4) The OIC then commands UNLOAD.
- (5) If an alibi occurs, the coach on whose point it occurs will announce ALIBI ON POINT NUMBER _____. All alibis will be fired at the completion of firing table II.
- (6) To fire the kneeling position of table II, the OIC commands—
 - (a) RAPID FIRE, 12-SECOND TIME LIMIT.
 - (b) FIRERS ASSUME THE KNEELING POSITION.
 - (c) FIVE ROUNDS.
 - (d) LOAD AND LOCK.
 - (e) READY ON THE RIGHT.
 - (f) READY ON THE LEFT.
 - (g) READY ON THE FIRING LINE.

Targets are exposed for 12 seconds, then edged. The firer fires 5 rounds, engaging each of the 3 targets during this exercise. The OIC commands UNLOAD.

- (7) Alibis are fired at the completion of table II. The position where the alibi occurred will be used by the firer when firing the alibi string of his remaining rounds. The firer will fire his remaining rounds at 3 seconds per round. Procedure for firing the alibi is as follows:
 - (a) The OIC commands—
 1. LOAD AND LOCK.
 2. READY ON THE RIGHT.
 3. READY ON THE LEFT.
 4. READY ON THE FIRING LINE.
 - (b) The OIC then will turn the targets to face the firer for three seconds, then edge them. The firer will fire only one shot each time the targets are faced until all rounds are fired.
 - (c) The OIC commands—
 1. UNLOAD, PLACE PISTOLS ON STANDS.
 2. CLEAR ON THE RIGHT.
 3. CLEAR ON THE LEFT.
 4. THE FIRING LINE IS CLEAR.

5. FIRERS AND COACHES MOVE FORWARD.

6. SCORE AND PASTE TARGETS.

c. *Table III—Quick Fire.*

- (1) The officer in charge has the firers move the pistol stands to the 35-meter line.
- (2) Each firer is assigned a firing point on the firing line.
- (3) Load 1 magazine with 4 rounds and 1 magazine with 6 rounds.
- (4) The officer in charge commands—
 - (a) QUICK FIRE FOUR ROUNDS.
 - (b) LOAD AND LOCK.
 - (c) READY ON THE RIGHT.
 - (d) READY ON THE LEFT.
 - (e) READY ON THE FIRING LINE.
 - (f) PISTOL AT THE READY POSITION, FORWARD, MARCH.
- (5) At this command, the firers on line move forward at a walk, holding the pistol at the ready position, and continue to walk until the targets are faced toward them.
- (6) The OIC has the targets faced toward the firers as they approach the 25-meter line. As the targets face, the firers assume the prone position, move the safety lock to the FIRE position, and fire all 4 rounds at the targets, engaging each target with at least 1 shot. The targets are exposed for 15 seconds, then edged.
- (7) The OIC commands—
 - (a) CLEAR ALL WEAPONS.
 - (b) RISE.
- (8) The OIC commands—
 - (a) SIX ROUNDS, LOAD AND LOCK.
 - (b) READY ON THE RIGHT.
 - (c) READY ON THE LEFT.
 - (d) READY ON THE FIRING LINE.
 - (e) PISTOL AT THE READY POSITION, FORWARD, MARCH.
- (9) As the firers approach the 15-meter line the targets are faced for 15 seconds. The firers assume the kneeling position, move the safety to the FIRE position, and fire 4 shots at the targets, engaging each target with at least 1 shot.

(10) At the end of 15 seconds, the officer in charge edges the target and commands—

(a) LOCK.

(b) RISE.

The firer announces ALIBI ON POINT NUMBER _____ if any have occurred.

(11) The OIC commands PISTOL AT THE READY POSITION, FORWARD, MARCH.

(12) The firers move forward and the targets are faced to the firers as they approach the 10-meter line. As the targets are faced, the firers engage 2 targets from the crouch position, with 1 shot each within 6 seconds. At the end of 6 seconds, the targets are edged.

(13) The OIC checks to confirm alibis, if any, and commands—

(a) CLEAR ALL WEAPONS.

Note. Safety noncommissioned officers examine each man's pistol to see that it is clear.

(b) CLEAR ON THE RIGHT.

(c) CLEAR ON THE LEFT.

(d) THE FIRING LINE IS CLEAR.

(e) HOLSTER PISTOL. (Slide to the rear.)

(f) MOVE FORWARD.

(g) SCORE AND PASTE TARGETS.

Note. Alibi targets will be pasted but not scored.

(14) The OIC then commands the firers to move to the 35-meter line at completion of scoring and pasting the targets.

(15) All alibis are then fired as a complete firing order, in the sequence listed in table III.

86. Procedure for Conducting Record Firing

a. Record firing is conducted using tables I, II, and III. The procedure for record firing is the same as for instruction practice (par. 85).

b. Regulations governing record firing are as follows:

- (1) *Coaching.* Coaching is not permitted during record firing. No person may render or attempt to render the firer any assistance while the firer is taking his position or after he has taken his position at the firing point. Each firer must observe the location of his own hits. The man assigned as coach has the duties of scoring the firer and loading the magazine with the correct amount of ammunition for each table of fire.

- (2) *Shots cutting edge of bull's-eye or lines.* A shot hole whose edge comes in contact with the outside of a scoring ring on the target is given the higher value. Any visible hit on an E target is valued at 10 points.
- (3) *Accidental discharges.* All shots fired by the firer when the target is ready, and when he has taken his place on the firing line, are considered in his score even if his pistol is not directed toward the target or is accidentally discharged.
- (4) *Firing on wrong target.* Shots fired upon the wrong target are entered as misses on the score card of the firer. The person at fault is credited with only such hits as he may have made on his own target.
- (5) *More than allotted number of shots on same target.* If more than the allotted number of rounds appear on the target, the coach scores the hits of lowest value equal to the number of shots fired, or the firer will be given the option of refiring that portion of the course in question.
- (6) *Unused cartridges in rapid and quick fire.* Each unfired cartridge is recorded as a miss.
- (7) *Score cards and scoring.*
 - (a) Score cards will be maintained by coaches. Entries on all score cards will be made in ink or with indelible pencil. Alterations or corrections will be made on the score card by the coach, who will strike over and initial each alteration or correction made. The cards at the firing point will be filled out as shown in figure 39.
 - (b) Officers and noncommissioned officers will exercise care to insure correct scoring. When record firing is completed, the score card will be signed by the scorer and firer, collected and signed by the officer or noncommissioned officer supervising the scoring, and turned over to the OIC of the range firing. Score cards will be retained by the unit commander until the firer's qualification is verified and published in orders.
- (8) *Hit values.* Values of hits on the 25-yard (standard American) pistol target, are 10 through 5. Any hit outside the 5 ring is a miss and recorded as zero. Each hit on the E target has a value of 10 points. For each E target that has not been hit with at least 2 shots, subtract 10 points from the total score of that particular table of fire.

87. Procedure for Conducting Familiarization Firing (Table IV)

a. The familiarization firing course consists of slow fire and quick fire exercises.

- (1) The OIC of firing will organize the firers into firing orders and assign a firer and coach to each firing point on the 15-meter line.
- (2) Each magazine will be loaded with five rounds of ammunition for the exercises.

b. Slow fire (10 rounds—15 meters) and quick fire (15 rounds—25 meters) in 5-shot strings will be fired at the group of three E targets. The standing position is used for familiarization firing.

- (1) The OIC commands—
 - (a) SLOW FIRE, FIVE ROUNDS.
 - (b) LOAD AND LOCK.
 - (c) READY ON THE RIGHT.
 - (d) READY ON THE LEFT.
 - (e) READY ON THE FIRING LINE.
 - (f) COMMENCE FIRING.
- (2) At the completion of slow fire the OIC commands—
 - (a) CEASE FIRING.
 - (b) CLEAR ALL WEAPONS, PLACE PISTOLS ON STANDS.
 - (c) CLEAR ON THE RIGHT.
 - (d) CLEAR ON THE LEFT.
 - (e) THE FIRING LINE IS CLEAR.
 - (f) MOVE FORWARD, SCORE AND PASTE TARGETS.

c. Quick fire, using the E target, bobbing (3), is conducted as follows:

- (1) One firer and one coach in each order will be assigned to a firing point on the 25-meter line.
- (2) When all firers are in their proper positions on the firing line, the OIC of the firing line has the targets edged. He then commands—
 - (a) FIVE ROUNDS.
 - (b) LOAD AND LOCK.
- (3) The officer in charge of firing then calls—
 - (a) READY ON THE RIGHT.
 - (b) READY ON THE LEFT.Any firer who is not ready calls out, NOT READY ON NUMBER _____.

- (4) If all is ready on the firing line, the OIC commands—
READY ON THE FIRING LINE. The safety on each weapon is disengaged and the firers remain at *raise pistol*.
- (5) The officer in charge of the firing line then signals for the targets to be exposed to the firers. As soon as the front of the targets begins to turn toward the firers, they aim at the target and fire one shot. Pistols are returned to *raise pistol* as soon as the one shot is fired, or as soon as the edge of the targets is again turned toward the firers. This procedure is continued until the targets have been exposed five times. The officer in charge of firing then commands—
 - (a) **CEASE FIRING.**
 - (b) **CLEAR ALL WEAPONS.**
- (6) On orders from the OIC, firers and scorers move to the targets to count the number of hits on each. The scorers make the correct entry on the score card.
- (7) Upon the conclusion of the scoring, the OIC directs that the targets be pasted and made ready for another firing order.

88. Procedure for Conducting Specialized Firing

a. Rules.

- (1) *Weapons.* Any pistol or revolver of 9-mm size or larger may be used. The same weapon must be used throughout. Any weapon not a standard item of issue must be inspected and approved by the officer in charge of range firing.
- (2) *Ammunition.* No midrange or reduced-charge ammunition is permitted.
- (3) *Holster.* A holster is required in tables VII through X, inclusive. Any serviceable holster designed for continuous wear is allowed. Impractical or unserviceable holsters (such as simple hook on the belt) are not permitted. If the holster has a retaining device, such as a strap or cover, the device must be used, securing the weapon in the holster before each draw. The same holster must be used throughout.
- (4) *Condition of readiness.* All weapons must be carried in the holster in a safe condition. This means revolvers with the hammer down and pistols with the manual safety set on **SAFE** or the hammer down. Neither re-

volvers nor pistols may be holstered on *half cock*. If a double action piston is used, it must be holstered with the hammer down and safety on. The firer's stance or position is not restricted in tables requiring a draw, except that both of the firer's hands must be at least 10 inches from the weapon when the signal to fire is given. (This provision serves to equalize the unpredictable factor of the actual position of the hands in a combat situation.)

- (5) *Timing*. Time in all tables is considered to be the interval between the signal to fire and the firing of the last (or only) shot in the string. The firer does not initiate his own signals, but must wait for the command of the line officer. In competition, if a firer moves so that his hands are closer than the prescribed distance (10 inches) from his weapon before the signal to fire is given, he will be required to repeat the string. If this happens more than twice the firer's score will be declared invalid.

b. Course of Fire.

- (1) The course is divided into six tables. It comprises a total of 50 rounds with a maximum of 500 points.
- (2) The following tables prescribe the conduct of the firing of the course:
- (a) *Table V*. This table tests the maximum accuracy of the firer and his weapon. Although time and position are unrestricted, the firer will not be permitted to use optical instruments because, to be effective in combat, the firer must know where his weapon will shoot before he opens fire.

Table V

Possible: 50

Range	Target	Shots	Strings	Position	Time
50 meters	50 - yard standard American pistol target. All hits inside the 8-inch ring, i.e., in the black, count 10. Hits inside the 5-inch ring but outside the 8-inch ring count 5. Hits outside the 5-inch ring count zero.	5	1	Any position that does not employ an artificial rest. Prone or sitting, using one - hand grip, or two-hand grip, is recommended but not required.	No limit.

- (b) *Table VI.* This table tests the effectiveness of deliberate fire at what is considered to be the maximum combat range of the hand gun under ideal conditions. The firer starts from the position of *raise pistol* and does not aim until the command to fire is given.

Table VI

Range	Target	Shots	Strings	Position	Time
50 meters	E-type silhouette	5	1	Standing	15 seconds

- (c) *Table VII.* This table tests the firer's ability to draw rapidly and shoot carefully at midranges. The firer holsters his weapon and stands facing the target area. A *standby* signal is given, and approximately 1 second later the target is turned or raised into his line of vision. It remains visible for 2½ seconds and then disappears; or is edged, without signal, during which time the firer draws and fires 1 shot. After each shot, the firer renders his weapon safe, reholsters, and signals *READY* to the line officer, who then repeats the process. Any stance, position, or system of firing that fulfills the above requirements is permissible.

Table VII

Range	Target	Shots	Strings	Time
25 meters	E-type silhouette	10	10	2½ seconds per shot

- (d) *Table VIII.* This table tests the firer's ability to draw and shoot very rapidly at short range, as well as his ability to reload his weapon and continue firing with speed and dexterity. The firer stands facing the target with his weapon holstered and loaded with 5 rounds. At the signal to fire, he draws and fires 5 shots, reloads, and fires 5 more. If the weapon holds 10 rounds or more, 10 rounds may be loaded initially and fired successively with reduced time allowance as shown in table VIII. Spare ammunition or a loaded magazine may be held in the free hand during the initial phase, prior to reloading.

Table VIII

Possible: 100

Range	Target	Shots	Strings	Time	
10 meters	E-type silhouette	10	1	Single-action, gate loading revolvers—19 seconds. Double - action, swing-out revolvers—16 seconds.	Pistols of capacity of less than 10 rounds—11 seconds. Pistols of capacity of 10 rounds or more—6 seconds.

(e) *Table IX.* This table tests the firer's ability to pivot and draw simultaneously, pick up targets rapidly, and engage several targets at once. The firer stands facing 45 degrees to either the right or the left of the line of sight to the target center. The weapon is loaded with six rounds and holstered. On the signal to fire, the firer draws and pivots simultaneously to face the target and fires two shots at each target in any order. He then reloads, reholsters, resumes his initial position, signifies to the line officer that he is ready to commence the second string. Two identical strings are fired, requiring 12 shots.

Table IX

Possible: 120

Range	Target	Shots	Strings	Time
10 meters	E-type silhouette 1 F-type silhouette 1 M-type silhouette	12	2	4 seconds per string

(f) *Table X.* This table tests the firer's ability to combine maximum speed with the necessary accuracy to hit a man at close range. The firer stands facing the target with his weapon loaded, holstered, and safe. At the signal to fire, he draws and fires one shot. He then checks his weapon for safety, reholsters, and awaits the next signal.

Table X

Possible: 80

Range	Target	Shots	Strings	Time
7 meters	E-type silhouette	8	8	1½ seconds per shot

c. *Scoring.* The firer's individual score is equal to the total number of hits multiplied by 10. The maximum possible is 500. The following scores indicate the degree of proficiency achieved by individuals:

- Superior—455 points
- Excellent—415 points
- Satisfactory—375 points

d. *Miscellaneous Information.*

- (1) *Overtime.* In tables VI, VIII, and IX, any shots fired after the time limit has expired count as misses. In addition, the firer loses the value of one additional hit (10 points) for the string in which the overtime occurred.
- (2) *Failing to fire.* In table X, if the firer cannot fire in 1½ seconds, he is told to fire the table at maximum speed and is given half credit on his resulting score.
- (3) *Individual competition.* In the event individual competition is desired, the time required for each string in tables IX and X will be recorded for each firer on his score sheet. In the cases of tied scores, the average time for the 2 strings in table IX will be computed to the nearest $\frac{1}{10}$ second. This average will be added to the average time required for each of the 8 shots in table X to the nearest $\frac{1}{10}$ second. The sum of the two averages will be compared and the tie will be resolved in favor of the faster firer.
- (4) *Test of general ability.* If this course is used as a test of general ability with the hand gun, the firer in question should be permitted to shoot it only twice, preferably on successive days, and his second score taken as an index of his skill.

89. Safety Precautions on the Range

a. Never place a loaded magazine in the pistol until you have taken your place at the firing point and have received the command to load.

b. Always remove the magazine and clear the pistol before leaving the firing point.

c. Always hold the loaded pistol at the position of *raise pistol* or *ready* except while aiming. If the arm becomes weary, transfer the pistol to the other hand, *keeping the weapon in the position of raise pistol.*

d. When firing ceases temporarily, lock the piece and hold it at position of *raise pistol* or *ready*.

e. If one or more cartridges remain unfired at the end of a firing string, remove the magazine and clear the weapon.

Section V. TARGETS AND RANGES

90. Targets

a. *E Target*. The E target is a drab silhouette the size of which is about the height of a soldier in the kneeling position. It is made of bookbinder's board or similar material (fig. 40). Hits are valued at 10 points. Any shot cutting the edge of the target is a hit.

b. *E Target, Bobbing (3)*. E target, bobbing (3), is so arranged as to be fully exposed to the firer for a limited time. The edge of the target is toward the firer when the target is not exposed (fig. 41).

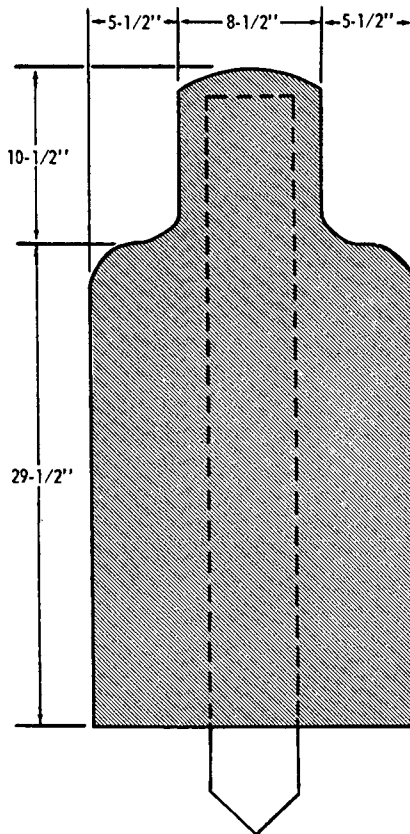

Figure 40. E target.

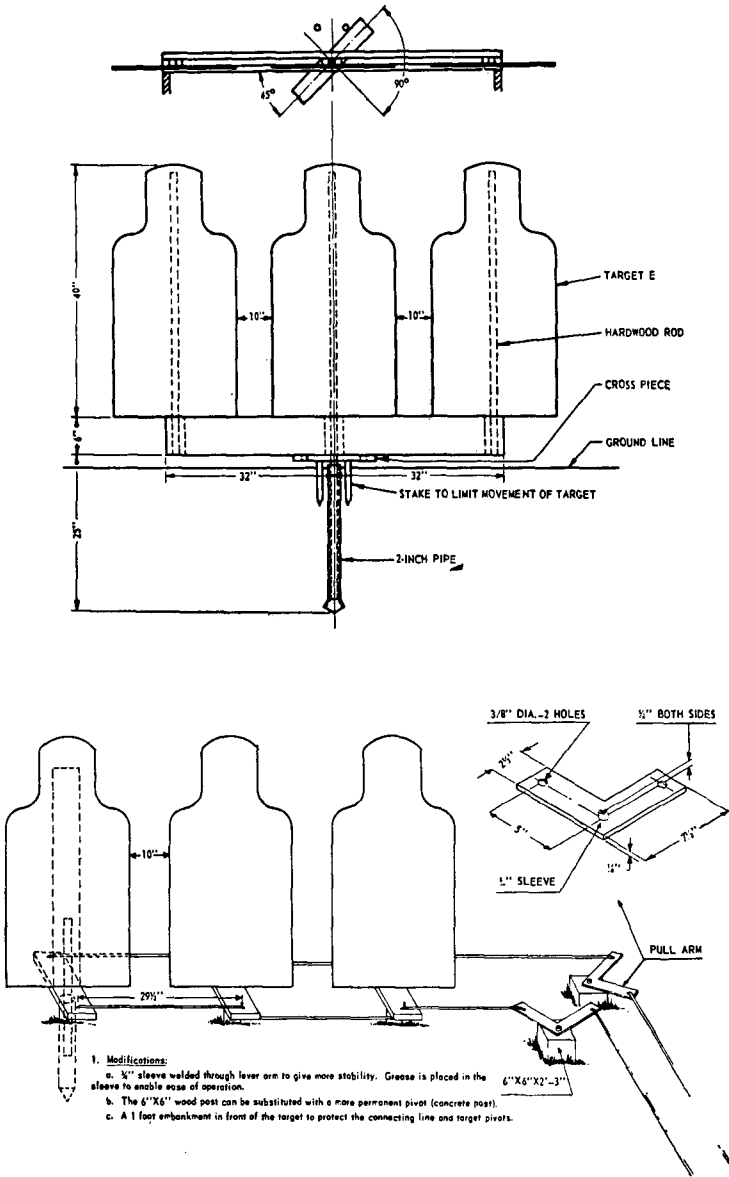

Figure 41. E target, bobbing (3).

c. 25-Yard Standard American Pistol Target. The 25-yard standard American pistol target is used in preparatory marksmanship training and for slow fire in range firing (fig. 42).

91. Range Construction

Organization and construction of a pistol range used in firing the qualification course with the caliber .45 pistol is shown in figure 43.

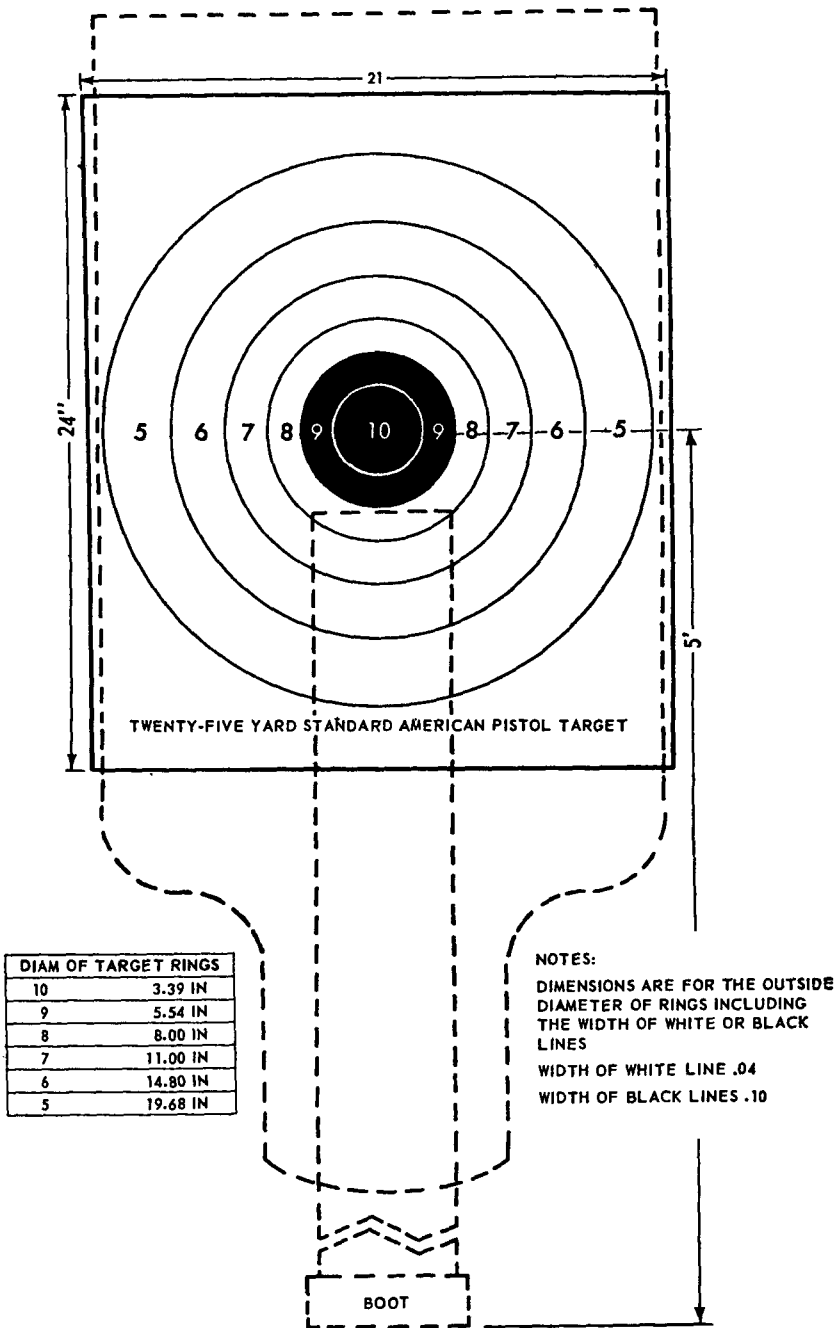

Figure 42. Standard American 25-yard pistol target mounted on E target.

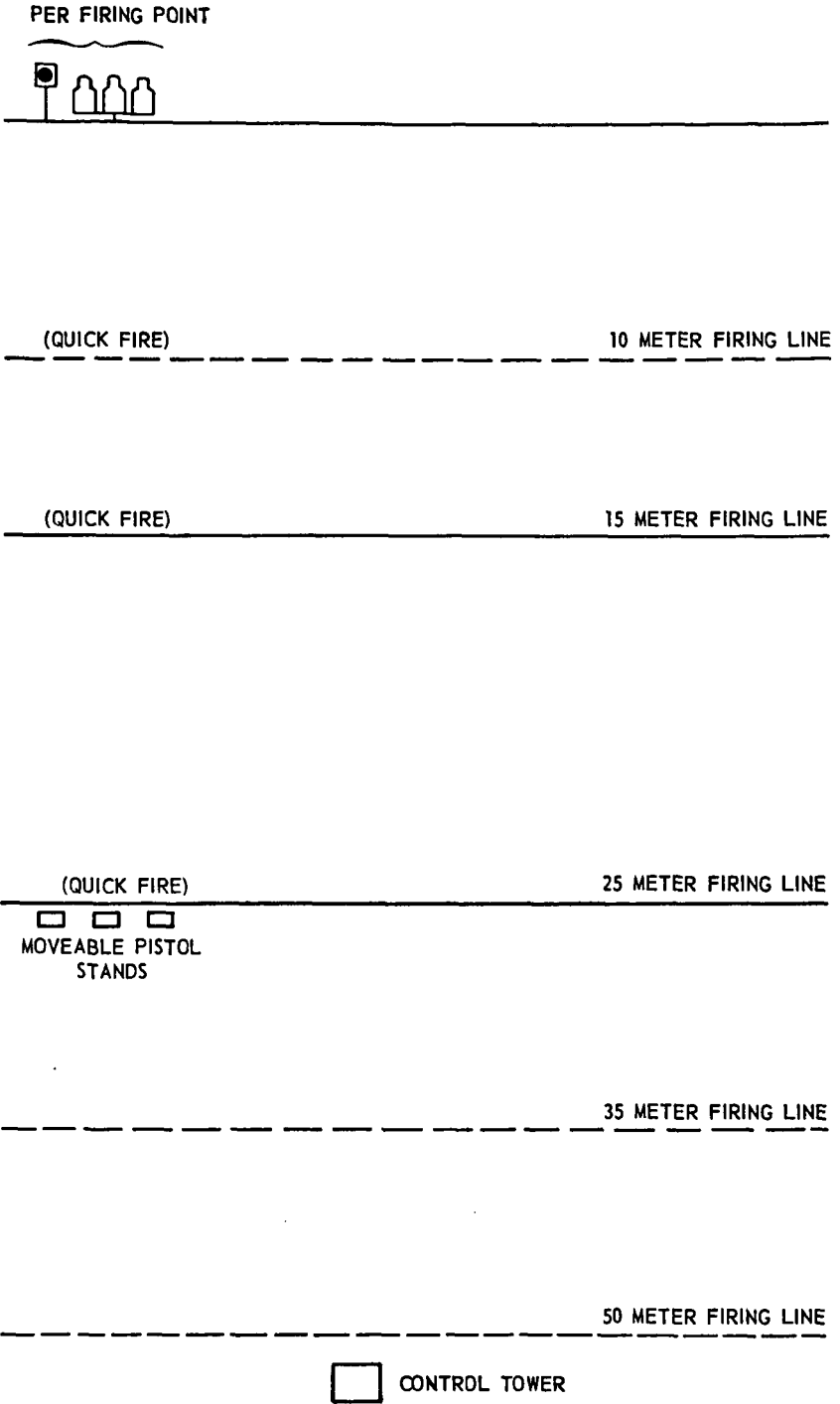

Figure 43. Diagram of a pistol range.

CHAPTER 5

ADVICE TO INSTRUCTORS

Section I. GENERAL

92. Purpose

The information and suggestions contained in this chapter are advisory and should be considered as a guide only. They are not intended to limit the imagination and initiative of the instructor.

93. Method of Instruction

It is advisable to make use of the applicatory system where instruction is conducted in subjects covered in this manual. Several phases comprise this system of instruction: explanation, demonstration, application (practical work), and examination.

a. Explanation. The initial explanation and demonstration of any particular phase of the instruction is presented to the assembled unit by the instructor, assisted by essential demonstration personnel. The general purpose of the entire course or period of instruction should be explained first. The various phases or steps of the course should then be presented in a series of explanations and demonstrations.

b. Demonstration.

- (1) Demonstrations that are skillfully conceived and executed expedite and simplify instruction as well as stimulate interest. Successful demonstrations are usually short and concise. The demonstrations incident to all subjects should be arranged in progressive sequence, and, where practicable, should alternate with practical work to permit the student to fix these successive phases of instruction in his mind.
- (2) The men who constitute the demonstration unit should be carefully selected for their intelligence, ability, and appearance. They should be thoroughly trained and rehearsed in the duties they are to perform, so that the demonstration will proceed smoothly and illustrate clearly and simply the phase of instruction being presented.
- (3) The equipment used for demonstrations should be the best available. A demonstration platform or an area is

essential in which the students can be assembled quickly at a position from which they can see and hear every part of the demonstration.

- (4) Interest is added and valuable instruction is provided by repeating demonstrations, including common errors, and requiring the students to detect these errors.

c. Application (Practical Work).

- (1) This third step of instruction is of major importance, since it gives the student an opportunity actually to accomplish that which has been previously explained and demonstrated.
- (2) During the practical work phase of instruction, best results are obtained if the unit is divided into groups. Groups should consist of four to eight men, depending upon the number of men undergoing instruction and the number of assistant instructors available. Each group is provided with a set of equipment and placed under the direct supervision of a trained assistant instructor. The group then executes the previously demonstrated phase of instruction, individuals rotating with the groups, until all men have mastered the instruction.
- (3) The initial allotment of time and equipment should be made carefully. However, the instructor should not hesitate to alter this allotment, if the majority of the men fail to master the instruction within the allotted time or are kept at one activity to the point of boredom. The frequent rotation of duties within each group is preferable to keeping each man in one position for a long time.

d. Examination. Upon completion of each phase of instruction an informal or practical examination should be conducted. In addition to the examination required before starting range practice, the organization commander should conduct such additional examinations as are necessary to insure that all men have completed the training.

Section II. MECHANICAL TRAINING

94. General

The unit to be instructed is assembled in a suitable area and divided into conveniently sized groups, each under the supervision of an assistant instructor. The instruction is centralized under the supervision of the unit instructor. Explanation and demonstration are concurrent, each assistant instructor demonstrating

the elements of the particular phase of instruction as the instructor explains it from the platform. For short periods of practical work, the instruction is decentralized under the assistant instructors.

95. Disassembly and Assembly of the Pistol

a. Equipment Required. One pistol, with magazine, per man; one pistol cleaning kit per group, and one disassembly mat (GTA 9-617) per two students.

b. Procedure. An assistant instructor disassembles and assembles the pistol as the instructor is explaining the procedure.

- (1) *Practical work.* Assistant instructors explain and demonstrate the procedure and the students perform each operation in unison with the assistant instructor. When acquainted with the procedure, each student disassembles and assembles the pistol without assistance.
- (2) *Questions and answers.* Students ask questions concerning points about which they are doubtful; instructors ask questions designed to test the effectiveness of their instruction.

96. Care and Cleaning

a. Equipment Required. Same as described in paragraph 95, plus additional equipment required for demonstration purposes.

b. Procedure.

- (1) The pistol is compared with any other mechanism and the necessity explained for keeping it clean, lubricated, and in working condition.
- (2) The proper method of cleaning the pistol is explained and demonstrated.
- (3) Students ask questions concerning points about which they are in doubt; the instructor asks questions designed to test effectiveness of his instruction.

97. Load, Fire, and Unload

a. Equipment Required. Pistol with magazines and dummy rounds.

b. Procedure.

- (1) The various phases of loading, unloading, or clearing the pistol are explained.
- (2) Students practice loading a magazine with dummy ammunition, inserting the magazine into the pistol, and loading and unloading the pistol.

- (3) Students ask questions concerning points about which they are in doubt; instructor asks questions designed to test effectiveness of his instruction.

98. Accessories

a. Equipment Required. One hip holster, shoulder holster, and pistol cleaning kit.

b. Procedure.

- (1) The use of each accessory is explained and demonstrated.
- (2) Students examine accessories.

99. Individual Safety Precautions

a. Equipment Required. Pistol with magazine.

b. Procedure.

- (1) Tests for safety devices are explained and demonstrated (half cock, safety lock, grip safety).
- (2) Students practice the application of the safety rules discussed and the tests of safety devices. Observation of the rules for safety becomes a habit only after constant practice over a long period. Instructors and assistant instructors must be constantly alert to enforce the safety rules.
- (3) Students ask questions concerning points about which they are in doubt; instructor asks questions designed to test the effectiveness of his instruction.

Section III. MANUAL OF ARMS FOR THE PISTOL

100. General

a. Concurrent Instruction. Instruction in the manual of arms for the pistol is conducted concurrently with dismantled drill and with previous instruction in this chapter.

b. Equipment Required. Each man is equipped with a pistol, 3 magazines (2 extra), holster, belt, and magazine pocket.

c. Procedure. The manual of arms for the pistol lends itself readily to the applicatory system of instruction.

- (1) The instructor, employing a trained demonstration unit, explains and demonstrates each movement in the manual.
- (2) Assistant instructors drill the groups in the various movements.
- (3) Each group is tested by the instructor at the end of the training period and a critique is conducted.

Section IV. MARKSMANSHIP

101. General

a. Marksmanship is the basic step in training the soldier to employ the pistol in combat. A soldier will subconsciously employ in combat the principles he has been taught in marksmanship, hence these principles must be sound.

b. The procedure used in conducting marksmanship instruction is similar to that used in the preceding sections of this chapter, except that it is more decentralized. During instruction in each step of marksmanship training, the entire unit is assembled initially under the unit instructor, who is assisted by a trained demonstration unit. Following the initial explanation and demonstration, the groups move to their individual sets of equipment and start practical work under the assistant instructors.

c. Firing exercises should be conducted under centralized control.

102. Preparatory Marksmanship Training

a. General.

- (1) During these periods, the soldier learns all the mechanics of target practice except actual firing. Preparatory marksmanship training may be performed in the vicinity of the barracks. Range equipment is not required but adds realism and interest to training.
- (2) Adequate time should be allowed and thorough supervision provided to insure that each man has thoroughly mastered the instruction before he is permitted to fire.
- (3) Each instructional phase is taken up in proper sequence, and training in that step is completed by each man before the next step is initiated. If men fail to progress uniformly, groups should be rearranged, so that instruction will not be held up by men who are slow to learn.
- (4) A careful record should be kept of the progress of each man and each group in order that the instructor will know the progress of instruction, and when the men are ready for range firing.

b. Equipment for Each Group.

- (1) One sighting bar.
- (2) One pencil or dowel triangulation device per two students.
- (3) A sheet of $\frac{1}{8}$ -inch miniature bull's-eyes per student.
- (4) A flat surface to support paper for triangulation exercises.

- (5) One 25-yard pistol target (standard American).
- (6) One group of 3 bobbing E targets.
- (7) One pistol with 3 magazines, holster, belt, and magazine pocket.
- (8) Material for blackening sights.
- (9) Pencils.
- (10) Additional equipment such as chalkboard, charts, and drawings as required by the instructor.

c. Procedure.

- (1) Each phase of training is initiated with a discussion covering the purpose and scope of the instruction and the manner in which it is to be conducted. Where appropriate, the instructor employs a trained demonstration group to emphasize important points of instruction.
- (2) When practical work is undertaken, groups are kept as small as circumstances permit and are supervised by assistant instructors.
- (3) The proficiency of the students is determined by means of oral examination and by close observation of the manner in which they accomplish practical work, such as the "county fair" system of examination.

103. Range Firing

a. General. The number of men who are to fire and the availability of range facilities are the primary factors affecting details of administration and supply. These matters must be the subject of detailed prior planning in order that firing may proceed smoothly and without interruption. Plans should include training of necessary assistants and demonstration units and adequate provision for keeping all men occupied by concurrent marksmanship training of an appropriate nature.

b. Equipment.

- (1) *Pistols.* Every effort should be made to detect and repair mechanical defects before marksmanship training is conducted. Proper lubrication of the pistol is essential. Lack of lubrication causes excessive malfunctions.
- (2) *Magazines.* Damaged or dirty magazines are the greatest single cause of malfunctions of the pistol. Principal defects in magazine are dents, spread lips, and the presence of sand or dirt inside the magazine.

c. Safety Precautions. Range officers, the officer in charge of firing and the commander responsible for the location of ranges

and the conduct of firing thereon must have a thorough knowledge of AR 385-63. Before firing is begun, all officers and men who are to fire or who are concerned with range firing will be familiarized with the safety precautions contained in paragraph 89.

Section V. TRAINING SCHEDULES

104. General

To aid in the individual training phase, training schedules for the courses in marksmanship training are shown in paragraphs 105 and 106. These schedules are based on the desirable number of training hours for a pistol course. Use them as a guide in preparing lesson plans. Conditions may require a longer or shorter period to complete the training. When time is available, more training should be added to the schedule. When suggested equipment and training aids are not available, improvise or substitute the best that are available. Unless otherwise noted, all references in the training schedules are to this manual. For more detailed information pertaining to training schedules and lesson outlines, see Army Subject Schedule 21-33.

105. Pistols, Automatic, Caliber .45, M1911 and M1911A1 (Qualification Course) (16 hours)

Period	Hour	Lesson	Text references	Area	Training aids and equipment
1	3	MECHANICAL TRAINING (4 hours). Characteristics, disassembly and assembly, functioning, and care and cleaning.	AR 370-5; FM 23-25, pars. 3-30, 40-46.	Classroom or field	For instructor: chalkboard; wooden working model; FB 7-273; GTA 9-620, 9-621, and 9-622; projector and screen; cleaning equipment. For each man: 1 pistol and GTA 9-617. For each group: table or shelter half.
2	1	Malfunctions, stoppages, immediate action, loading, unloading, ammunition, safety precautions. PREPARATORY MARKSMANSHIP TRAINING (4 hours).	FM 23-35; pars. 31-39, 51-56.	-----do-----	Same as first period, plus ammunition display, less FB 7-273.
3	2	Aiming, position, and trigger squeeze exercises.	FM 23-35; pars. 65-70	Pistol range or field.	For all: training aids listed in pars. 65-70.
4	1	Slow, rapid, and quick fire exercises.	FM 23-35; pars. 71-76	Pistol range or field.	For all: One 25-yard (std American) target, one E target, one score card for each firer.
5	1	Review and examination	FM 23-35; par. 77	-----do-----	For all: all equipment used in previous periods.

Period	Hour	Lesson	Text references	Area	Training aids and equipment
6	4	RANGE FIRING (8 hours) --- Safety precautions, instruction practice firing, tables I, II, and III.	AR 370-5; AR 385-63----- FM 23-35; pars. 79, 85, 89-----	Pistol range-----	For all: same as third period, plus ammunition and 1 score card for each man, one 25- yard pistol target (std Amer- ican), 1 E target (group of 3).
7	4	Record firing, tables I, II, and III.	AR 370-5; FM 23-35; pars. 80, 86, 89.	Pistol range-----	Do.

106. Pistols, Automatic, Caliber .45, M1911 and M1911A1 (Familiarization Course) (8 hours)

Period	Hour	Lesson	Text references	Area	Training aids and equipment
1	1	MECHANICAL TRAINING (1 hour). Characteristics, general disassembly and assembly, immediate action, and care and cleaning.	AR 370-5; FM 23-35, pars. 3, 5, 6-11, 39-45.	Classroom or field	For instructor: chalkboard; wooden working model; FB 7-273; projector and screen. For each man: 1 pistol, 1 GTA 9-617, and accessories. For each group: 1 table or shelter half.
2	3	PREPARATORY MARKSMANSHIP TRAINING (3 hours). Marksmanship training in aiming, positions, trigger squeeze, slow and quick fire exercises, and safety precautions.	FM 23-25, pars. 65-76	Pistol range or field.	For all: training aids listed in pars. 65-70, one 25-yard pistol target (std American), 1 E target.
3	4	RANGE FIRING (4 hours) Safety precautions and familiarization firing.	AR 370-5; AR 385-63; FM 23-35, pars. 87, 89.	Pistol range	For all: same as second period, plus ammunition, 1 score card for each man; one 25-yard pistol target (std American), 1 E target, bobbing (group of three) for each firing point.

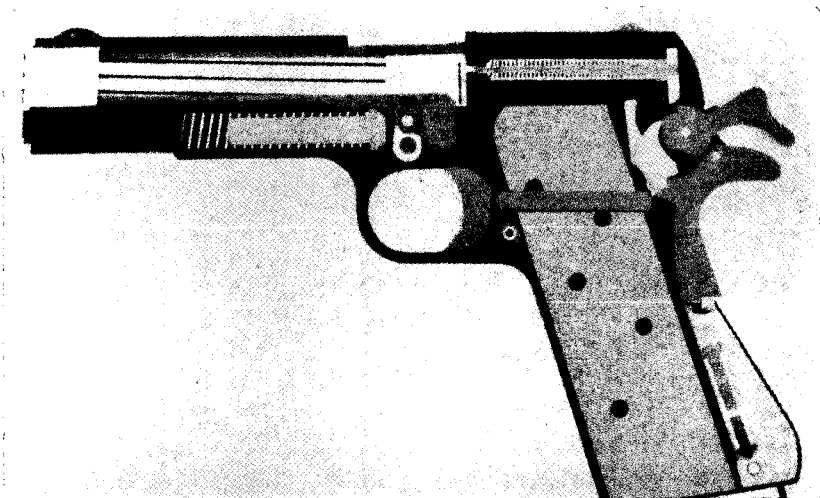

Figure 44. Wooden working model.

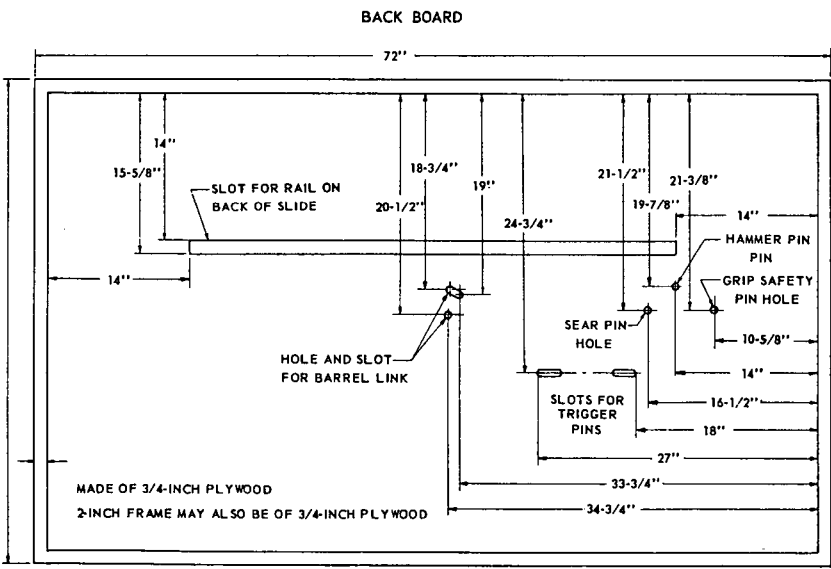

Figure 45. Backboard for wooden working model.

Section VI. TRAINING AIDS

107. General

In conducting training, make the greatest possible use of working models, charts, and other suitable visual training aids. Excellent pistol training aids are available through normal supply

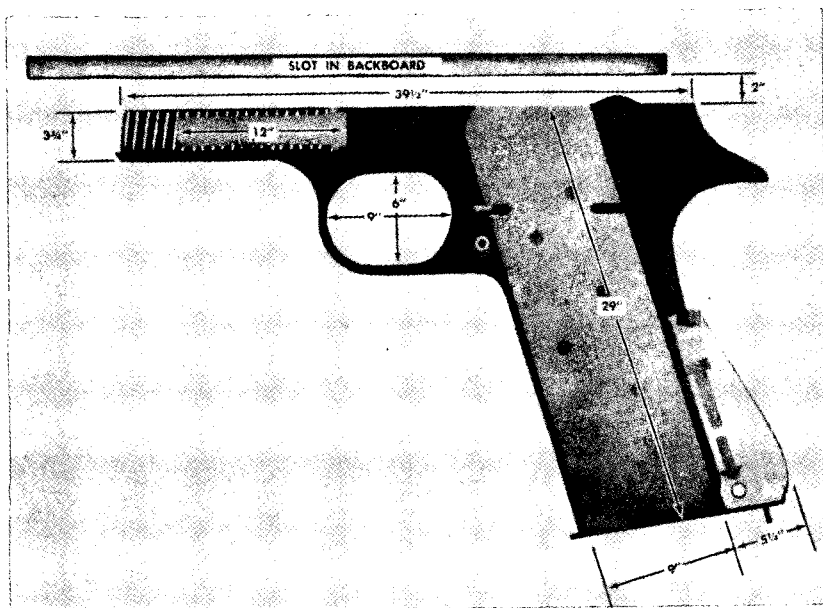

Figure 46. Parts to paint on backboard.

channels, or they can be constructed locally. Some recommendations and suggestions concerning the construction and use of various training aids are listed below.

a. Scrap lumber in good condition or plywood may be used to construct models. Other materials that are needed in making models are nails, screws, and springs.

b. Charts and models should be painted with contrasting colors to help the students distinguish the various parts.

c. All lettering on charts and other training aids must be large enough to be read easily. Lettering $2\frac{1}{2}$ inches high is readable at a distance of 75 feet.

108. Wooden Working Model

a. A large scale working model (fig. 44) is an excellent training aid for teaching nomenclature of parts and the cycle of operation of the pistol. Figures 44 through 50 show the dimensions of the parts and a detailed plan of construction is given in (1) through (6) below.

- (1) Cut out the parts and drill holes and slots in backboard (figs. 44-50).
- (2) Paint the outline of the receiver and other parts on the backboard (fig. 46).

SLIDE

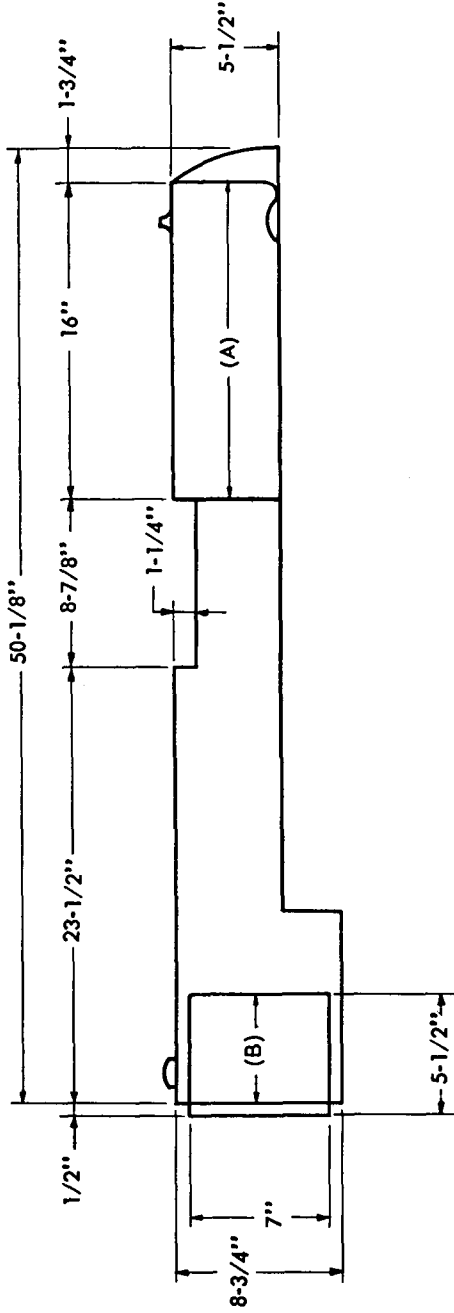

SLIDE IS OF 3/8-INCH PLYWOOD

ITEM (A) IS A 3/8-INCH PLYWOOD PIECE ATTACHED TO SLIDE, MAKING TOTAL THICKNESS 3/4-INCH AT THIS POINT

ITEM (B) IS TWO 3/8-INCH PLYWOOD PIECES ATTACHED TO SLIDE, MAKING TOTAL THICKNESS 1-1/8 INCHES AT THIS POINT

Figure 47. The slide.

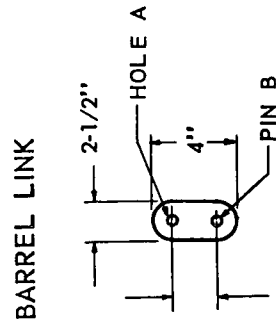

HOLE A—THE DOWEL ATTACHED TO THE BARREL PASSES THROUGH THIS HOLE
 PIN B IS GLUED TO LINK AND PASSES THROUGH BACKBOARD

MADE OF 3/4-INCH PLYWOOD

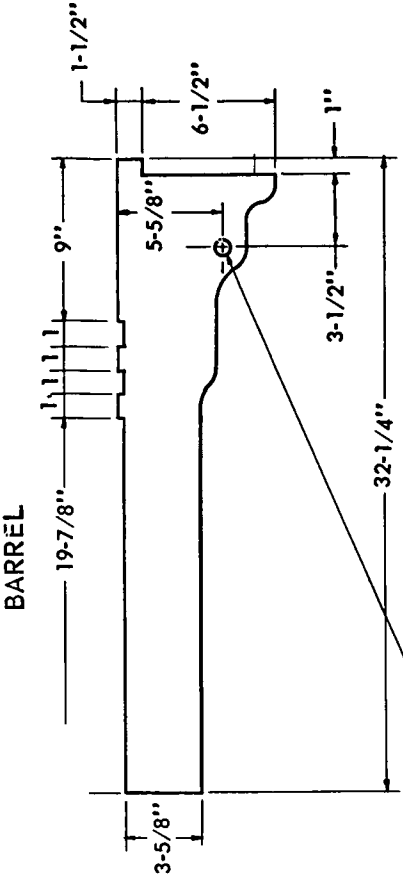

5/8-INCH DOWEL GLUED TO BARREL SO AS TO PASS THROUGH TOP HOLE IN BARREL LINK AND BACKBOARD

MADE OF 3/8-INCH PLYWOOD

Figure 48. The barrel and barrel link.

TRIGGER

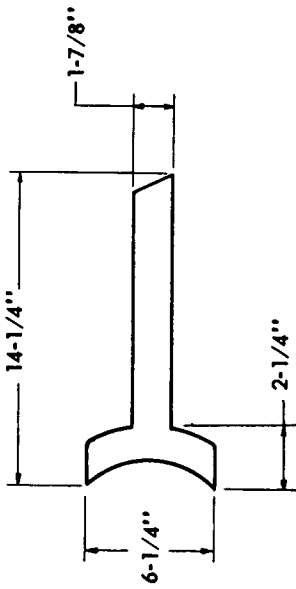

TWO 5/8-INCH DOWELS ATTACHED TO REAR OF TRIGGER TO WORK IN SLOTS IN BACKBOARD, SO TRIGGER MAY BE MOVED TO FRONT AND REAR, ALSO TO HOLD TRIGGER TO BACKBOARD

MADE OF 3/4-INCH PLYWOOD

HAMMER

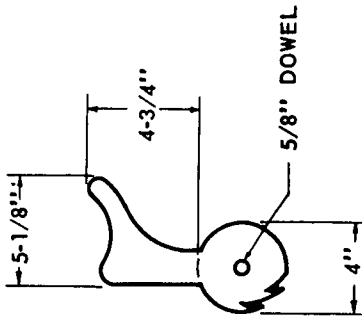

5/8-INCH DOWEL GLUED TO HAMMER AND PASSES THROUGH BACKBOARD

MADE OF 3/4-INCH PLYWOOD

Figure 49. The trigger and hammer.

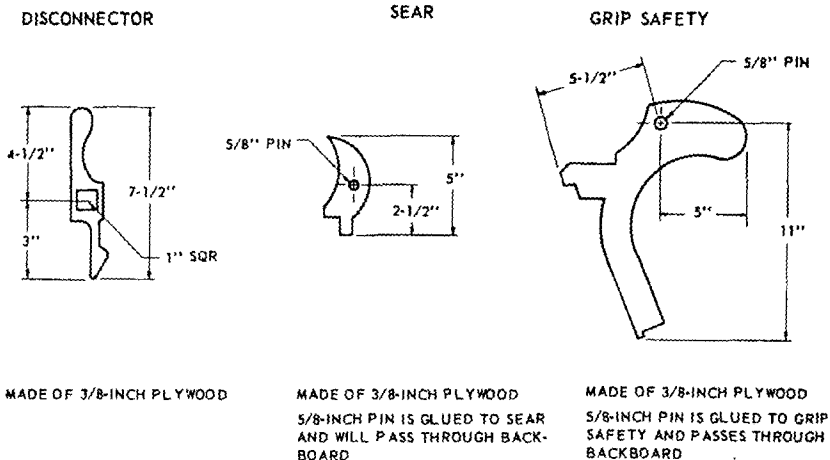

Figure 50. The disconnector, sear, and grip safety.

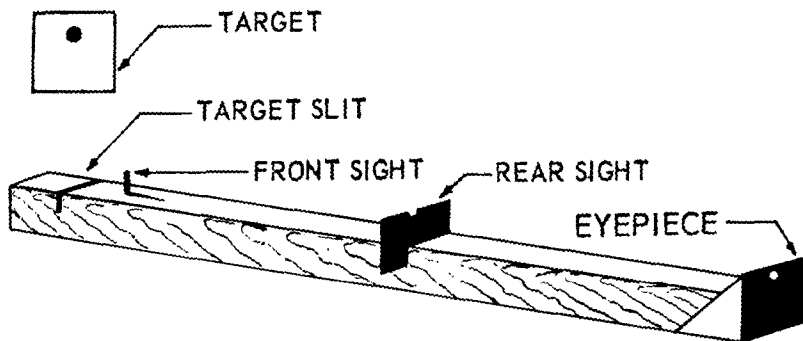

Figure 51. The sighting bar.

- (3) Paint the slide (fig. 47) and attach to backboard (fig. 45).
- (4) Assemble barrel and barrel link (fig. 48) to backboard.
- (5) Assemble trigger and hammer (fig. 49) to backboard.
- (6) Assemble disconnector, sear, and grip safety (fig. 50) to backboard.

b. Nails and springs are used on the rear of the backboard to hold the parts and cause them to operate. The parts may have to be sanded slightly to make them fit and operate properly.

c. Lubricate the working model with a wax candle or hand soap. Paint the parts of the aid with contrasting colors so that all parts can be seen clearly.

109. Charts and Other Aids

a. Some of the teaching points that can best be presented by a chart are—

- (1) Steps in the cycle of operation.

- (2) Steps in care and cleaning.
- (3) Characteristics and general data.
- (4) Steps in preparatory marksmanship training.

b. Other helpful training aids that can be procured through supply channels or made by the unit are—

- (1) Sighting bars (fig. 51).
- (2) Operable Transparency 17-1, Caliber .45 Pistol.
- (3) Training Device (DVC) 23-1, Pistol Marksmanship Device.
- (4) Film Bulletin 7-273, "Infantry Weapons and Their Effects."
- (5) M15 sight device.
- (6) Graphic training aids:
 - (a) GTA 9-617, Pistol, Automatic, Caliber .45, M1911A1, Disassembly Mat.
 - (b) GTA 9-620, Pistol Safety Lock Mechanism.
 - (c) GTA 9-621, Function of Pistol Grip Safety.
 - (d) GTA 9-622, Pistol Firing Mechanism.

PART THREE
REVOLVER, COLT, CALIBER .38, 2-INCH BARREL,
DETECTIVE SPECIAL

CHAPTER 6
INTRODUCTION

110. Description
(figs. 52 and 53)

a. The Revolver, Colt, Caliber .38, 2-Inch Barrel, Detective Special, is a cylinder-loaded, exposed-hammer, selective-double-action, hand weapon. The revolving cylinder of the weapon has six chambers, permitting the weapon to fire six shots without being reloaded. When the cylinder is loaded and closed, the revolver is ready for firing. The action of cocking the hammer causes the cylinder to rotate clockwise and aline the next chamber with the barrel. The exposed hammer may be cocked by the thumb or may be cocked and dropped by the continuous squeezing of the trigger, which performs the double action of cocking and releasing the hammer.

b. If one or more of the chambers are empty, the cylinder should be rotated so that a loaded chamber will be moved into line with the barrel when the revolver is cocked. The closed cylinder may be rotated to its proper position by holding the hammer back at about one-fourth full cock. With the hammer down, the first loaded chamber should be next on the left of the one alined with the barrel.

c. The rate of fire is limited by the dexterity of the firer in reloading the cylinder and by his ability to aim and squeeze.

111. General Data

Weight.....	1 pound, 5 ounces.
Total length.....	6¾ inches.
Barrel:	
Length.....	2 inches.
Diameter of bore.....	0.346-0.347 inch.
Diameter of rifling.....	0.353-0.354 inch.
Number of grooves.....	6.
Grooves:	
Width.....	0.120-0.124 inch.



Figure 52. Revolver, Colt, Caliber .38, 2-Inch barrel, Detective Special.

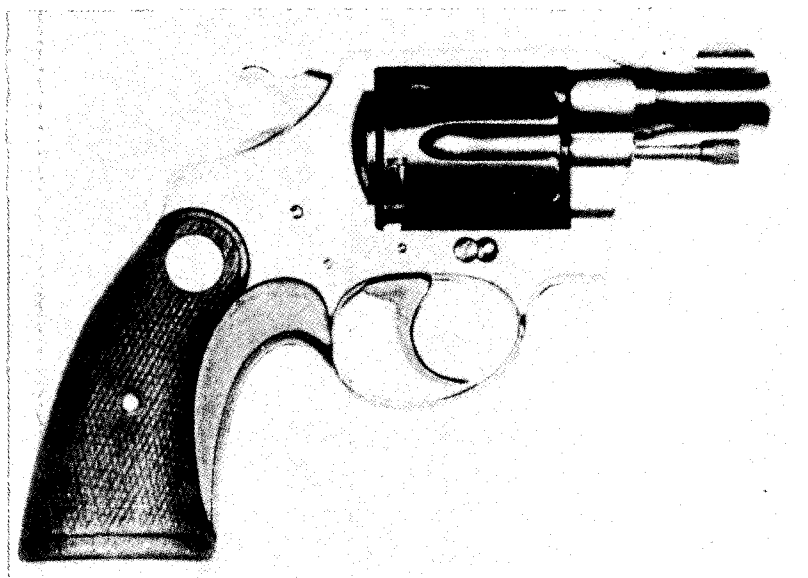

Figure 53. Revolver, Colt, Caliber .38, 2-Inch barrel, Detective Special, with commercially procured grip adapter.

Depth	-----	0.0035 inch.
Rifling, one turn in	-----	16 inches (left).
Lands:		
Width	-----	0.055-0.059 inch.

Cylinder:
 Length..... 1.570 inches.
 Diameter..... 1.4015 inches.
Chambers:
 Number..... 6.
Diameter:
 Maximum..... 0.380 inch.
 Minimum..... 0.359 inch.
Muzzle velocity..... (158-grain bullet) 870 feet per
 second.
Type of front sight..... Blade, fixed.
Type of rear sight..... Groove, fixed.
Maximum effective range..... 50 meters.

CHAPTER 7

MECHANICAL TRAINING

Section I. DISASSEMBLY AND ASSEMBLY

112. Disassembly Limitations

Revolvers are not disassembled by user personnel. The only part the soldier is authorized to remove from the revolver is the side plate, and this must be performed under the supervision of an officer or a noncommissioned officer. The side plate is removed only for performance of emergency maintenance. When parts of the revolver become broken or worn, the weapon must be turned in to an ordnance maintenance unit for repair. To remove the side plate, see procedures listed in TM 9-2027.

Section II. LOADING, FIRING, AND UNLOADING

113. Load

To load the revolver, hold it in the left hand, thumb latch to the left, with the muzzle pointed down at an angle of approximately 75 degrees (fig. 54). Press the latch to the rear with the right thumb and push the cylinder out with the fingers of the left hand. With the right hand, insert a cartridge into each chamber of the cylinder. Close the cylinder with the left thumb.

114. Fire

a. The revolver may be fired single action or double action. To fire single action, cock the revolver by pulling back the hammer with the thumb as far as it will go. Obtain the correct sight alignment and sight picture, and squeeze the trigger. To fire successive shots single action, the trigger must be released, the revolver must be cocked with the thumb, and the trigger squeezed for each shot.

b. To fire double action, apply a steady rearward pressure to the trigger with the trigger finger until the hammer cocks and falls forward striking the primer of the cartridge. The trigger must be released after each shot and squeezed again for each succeeding shot.



Figure 54. Load and unload.

115. Unload

To unload the revolver, place it in the left hand, thumb latch to the left, with the muzzle pointed down at an angle of about 75 degrees. Press the latch to the rear with the right thumb and push the cylinder out with the fingers of the left hand (fig. 54). Eject the cartridges or cartridge cases by pressing the ejector rod head with the left thumb while steadying the revolver at the stock with the right hand. Remove the cartridges or cartridge cases with the thumb and forefinger of the right hand.

Section III. SAFETY DEVICES AND SAFETY TESTS

116. Safety Devices

The revolver has two safety devices. These devices are the safety and the cylinder bolt.

a. The safety prevents the hammer from striking the primer of a cartridge by blocking the hammer and preventing it from moving forward enough to strike the primer of the cartridge. The safety blocks the hammer each time the trigger is released.

b. The cylinder bolt, another safety device, insures positive alinement of one of the chambers of the cylinder with the barrel each time the cylinder rotates.

117. Tests of Safety Devices

The safety devices should be tested frequently, and always before firing the revolver. The following procedure is used to test the safety devices.

a. *Safety.* With the revolver unloaded and cylinder closed, cock the hammer. Holding the hammer back with the thumb, squeeze the trigger and let the hammer move forward about $\frac{1}{4}$ inch, still holding it with the thumb. Release the trigger. Then release the hammer and let it go forward. If the firing pin projects through the hole in the frame, the safety is faulty.

b. *Cylinder Bolt.* With the hammer down attempt to rotate the cylinder. If more than about $\frac{1}{64}$ inch in rotation is possible, the cylinder bolt is faulty. Repeat this test with the hammer cocked.

Note. With the hammer about one-fourth cocked the cylinder should rotate freely.

Section IV. MALFUNCTIONS, STOPPAGES, AND IMMEDIATE ACTION

118. General

Most stoppages or malfunctions of the revolver can be prevented by proper care and cleaning before and after firing. If a stoppage occurs, and immediate action does not reduce the stoppage, the revolver should be turned in to ordnance for repair.

119. Malfunctions

A malfunction is a failure of the weapon to function satisfactorily. Malfunctions are classified as defects in the weapon that normally do not cause a break in the cycle of operation. Listed below are some malfunctions and their causes:

a. The safety does not block the trigger: Caused by a faulty safety or safety lever.

b. Failure to function freely: Caused by lack of lubrication, use of improper lubricants, or dirt in the revolver. Corrective action consists of cleaning and lubricating properly.

120. Stoppages

a. A stoppage is any unintentional interruption in the cycle of operation. If the revolver stops firing through no fault of the firer, or an attempt to fire is made and the weapon does not fire, a stoppage has occurred.

b. Stoppages can normally be attributed to failure to feed or fire.

(1) *Failure to feed.* Feeding is the process that begins with a cartridge properly positioned in the cylinder and ends with the firing chamber of the cylinder alined with the barrel. Failure to feed is a failure of some part of the revolver or of the ammunition to properly aline the firing chamber with the barrel. It is generally caused by—

(a) A broken or defective cylinder bolt (spring), or latch (pin, spring), hand rebound lever, or ratchet on the ejector.

(b) A dirty, malformed, or battered cartridge.

(c) Dirt or an obstruction in the chamber. Corrective action consists of cleaning, if dirty, and checking to determine if there are any obstructions or any defective parts. If the failure is caused by dirty, malformed, or battered cartridges, they must be removed.

(2) *Failure to fire.* Firing is the process that begins with the firing chamber of the cylinder alined with the barrel and ends with the firing of the cartridge. A failure to fire is caused by faulty ammunition or by some part of the firing mechanism not performing properly. Failure to fire is generally caused by a—

(a) Broken firing pin.

(b) Weak or broken mainspring.

(c) Defective primer.

(d) Broken hammer strut.

(e) Dirt or obstruction under the hammer. Corrective action consists of determining which part or parts are the cause of the malfunction and the subsequent replacement of the faulty parts. If the primer of the

round is deeply indented, the cartridge is defective. If the primer is only slightly dented, the firing pin is worn or broken. A weak or broken mainspring may not furnish enough energy to drive the hammer forward and allow the firing pin to forcefully strike the primer of the cartridge.

121. Immediate Action

a. Immediate action is the prompt action taken by the firer to reduce a stoppage. The procedures for applying immediate action should become instinctive for the soldier armed with the revolver. It is applied automatically in an effort to reduce the stoppage without attempting to discover the cause at that time.

b. The procedure for applying immediate action when the revolver fails to fire and the hammer is forward (cartridge misfires) is as follows:

- (1) Keep the revolver pointed at the target and recock it with the thumb. (This rotates the cylinder, and the firing chamber, with a new cartridge, is alined with the barrel.)
- (2) Aim and attempt to fire.

c. The procedure for applying immediate action when the revolver fails to fire and the hammer is cocked or partly cocked is as follows: Keep the revolver pointed at the target and attempt to recock it with the thumb. If the weapon cocks, aim and attempt to fire.

Note. If the application of the procedure for immediate action does not clear the stoppage, ordnance personnel must be called to complete clearance.

d. If the revolver fails to fire after the application of immediate action, the stoppage is probably an unusual type and will require a detailed inspection for the cause. If the firer cannot ascertain the cause of the stoppage, the weapon should be sent to ordnance for inspection and repair.

Section V. CARE AND CLEANING

122. General

The information in paragraph 40 applies also to the revolver.

123. Cleaning Materials, Lubricants, and Rust Preventives

The instructions in paragraph 41 apply also to the revolver.

124. Daily Preventive Maintenance

The instructions in paragraph 42 apply also to the revolver.

125. Care and Cleaning Before Firing

Before the revolver is fired, the bore and chambers of the revolver must be cleaned and dried. The exterior of the revolver should be dried to remove excess oil. The cylinder and the ejector rod inside the cylinder should be lightly oiled, and a drop or two of oil should be placed on the interior parts of the revolver to insure proper operation. All screws should be tightened before firing and should be checked during and after firing to see that they are tight.

126. Care and Cleaning After Firing

a. After the revolver has been fired, the primary consideration is the prevention of rust. The residue left in the bore and chambers after firing consists mainly of primer salts, powder ashes, and carbon. The primer salts collect moisture and promote rust. This salt collects in the chambers and throughout the bore. Rifle bore cleaner removes it, as well as the powder ashes and carbon.

b. When a revolver has been fired, the bore and chamber must be cleaned thoroughly not later than the evening of the day on which it is fired and each day for at least the next three days.

c. To clean the bore after firing, open the cylinder, hold the revolver with the muzzle pointed up, toward the operator, and hold the cylinder in its fully opened position. Saturate a swab with rifle bore cleaner or soapy water. Insert the swab in a cleaning rod and move forward and back through the bore several times. Run the cleaning rod, with cleaning brush attached, back and forth through the bore one or two times. Again run several swabs saturated with cleaner or water through the bore. Follow this with dry swabs until the bore is clean. When the bore is clean, saturate a swab in rifle bore cleaner and run it back and forth through the bore several times.

d. Repeat the operation in *c* above for each of the chambers of the cylinder, holding the revolver with the muzzle toward the operator, cylinder beneath the frame.

e. After performing steps *c* and *d* above, inspect for residue and corrosion. If none is apparent, saturate a swab with oil, lubricating, preservative, and swab the bore and chambers making certain that the bore and all exposed metal parts of the revolver are covered with a light coat of oil.

f. Due to corrosion caused from the gas that escapes between the barrel and the cylinder, the following parts require special care after firing:

- (1) The frame just above the cylinder in the rear of the barrel.
- (2) The nose of the hammer.
- (3) The firing pin channel and the hammer groove in the frame.

127. Care and Cleaning After a CBR Attack

The instructions in paragraph 46 apply also to the revolver.

Section VI. REPAIR PARTS AND ACCESSORIES

128. Repair Parts and Accessory Allowances

Allowances for accessories and repair parts are prescribed in Department of the Army Supply Manual ORD 7, SNL B29. The following holsters are provided for use specifically with the Revolver, Colt, 2-Inch Barrel:

- a.* Holster, hip, Revolver, Colt, Caliber .38, 2-Inch Barrel, Detective Special.
- b.* Holster, shoulder, Revolver, Colt, Caliber .38, 2-Inch Barrel, Detective Special.

Section VII. AMMUNITION

129. General

Ammunition for use in the Revolver, Colt, Caliber .38, 2-Inch Barrel, Detective Special, is authorized by Department of the Army Supply Manual 9-5-1305.

130. Classification

The nomenclature and types of ammunition authorized for use in the caliber .38 revolver are listed below:

- a.* Cartridge, ball, revolver, caliber .38, short Colt, 125- or 130-grain bullet.
- b.* Cartridge, ball, revolver, caliber .38, special, midrange, 146-grain bullet (wad-cutter).
- c.* Cartridge, ball, revolver, caliber .38, special, midrange, 148-grain bullet, nicked cartridge case (wad-cutter).
- d.* Cartridge, ball, revolver, caliber .38, special, 158-grain bullet.

- e. Cartridge, ball, revolver, caliber .38, special, 158-grain bullet, steel jacket (copper-plated).
- f. Cartridge, ball, revolver, caliber .38, special, 200-grain bullet, nickeled cartridge case (super-police).
- g. Cartridge, ball, revolver, caliber .38, 200-grain coated bullet (Lubaloy), nickel-plated cartridge case (super-police).
- h. Cartridge, blank, revolver, caliber .38, special.
- i. Cartridge, test, high-pressure, revolver, caliber .38, special, 158-grain bullet (for use only in ordnance test of weapons).
- j. Cartridge, tracer, revolver, caliber .38, special, 120-grain bullet, steel jacket.
- k. Cartridge, tracer, revolver, caliber .38, special, 158-grain bullet, steel jacket.

131. Care, Handling, and Preservation of Ammunition

Paragraphs 52 through 56.

CHAPTER 8

MANUAL OF ARMS FOR THE REVOLVER

132. General

a. The movements described in this chapter differ in purpose from the manual of arms for the rifle, because they are not designed to be executed in exact unison in that, with few exceptions, no real necessity exists for their simultaneous execution. They are not planned as a drill to be executed in cadence with snap and precision; they are designed to provide safe and uniform methods of handling the revolver.

b. Officers and enlisted personnel armed with the revolver render the hand salute at the command PRESENT ARMS. They hold the salute until the command ORDER ARMS is given.

133. Raise Revolver

The command is RAISE REVOLVER. At the command REVOLVER unbutton the strap of the holster with the right hand and grasp the stock. Draw the revolver from the holster with the thumb and last three fingers of the right hand, holding the stock with the forefinger extended outside the trigger guard. Incline the barrel of the revolver upward at an angle of 30 degrees from the vertical, and raise the hand as high as, and approximately six inches in front of, the point of the right shoulder.

134. Inspection Arms

The command is INSPECTION ARMS. At the command ARMS assume the position of *raise revolver* if not already in that position. Open the cylinder by operating the thumb latch with the forefinger of the left hand and pushing the cylinder to the left with the right forefinger. Return the left hand to the side. Raise the revolver to a point where the cylinder and chambers can be visually inspected and check for clearance. After this inspection, return to the position of *raise revolver*. If the revolver is inspected in ranks and the inspecting officer takes the revolver for inspection, lower the right arm and hand smartly to the side, as in the position of attention. When the inspecting officer is ready to return the revolver, raise the right arm and hand to the *raise revol-*

ver position. After the revolver is returned by the inspecting officer, take the position of *raise revolver* and, without command, execute RETURN REVOLVER.

135. Return Revolver

The command is RETURN REVOLVER. At the command RETURN, close the cylinder with the forefinger of the left hand. At the command REVOLVER, lower the revolver, muzzle down, to the holster; raise the holster strap with the right thumb; insert the revolver in the holster; button the holster strap with the right hand; and resume the position of *attention*.

CHAPTER 9

MARKSMANSHIP TRAINING

Section I. GENERAL

Note. The instructions in paragraphs 60 through 62 apply also to marksmanship training with the revolver.

Section II. PREPARATORY MARKSMANSHIP TRAINING

Note. The instructions in paragraphs 63 through 66 apply also to preparatory marksmanship training for the revolver.

136. Grips and Positions

a. General. To assume the proper position for firing, it is necessary to know the correct position of the body with relation to the target and how to grip the revolver correctly. The one-hand grip is used for firing from standing and hip-shooting positions. The two-hand grip is used when firing from the prone, kneeling, and sitting positions. Once a correct grip has been taken, it must be maintained exactly, even when other actions such as cocking the hammer are performed, if the firer is to shoot a tight shot group.

b. One-Hand Grip. The revolver can be held in any of three different grips, depending upon the size of the firer's hand and the degree of firmness desired. The different grips should be practiced and the one adopted that best suits the conformation of the hand.

- (1) *Conventional grip.* To take the conventional grip, pick up the revolver and place it in the firing hand. The lower three fingers grip the stock firmly to prevent recoil from twisting the weapon in the hand and causing the firer to lose uniformity of grip. The thumb is held as shown in figure 55 to aid in controlling the revolver during trigger squeeze and recoil. The trigger finger is placed inside the trigger guard, so that any portion of the finger from the tip to the first joint will contact the

trigger. No part of the trigger finger should touch the frame. This procedure will aid in applying pressure straight to the rear during trigger squeeze.

- (2) *Alternate grip.* The short barrel and light frame of the caliber .38 revolver cause the recoil to be accentuated, which may cause injury to the ball of the thumb when the revolver is gripped in the conventional manner. For that reason, there are two alternate methods of gripping the revolver: (1) as shown in figure 56 with the thumb down; and (2) with the little finger curled beneath the butt and the thumb held down (fig. 57).
- (3) *Grip with attachment.* Persons with unusually large hands will experience some difficulty in gripping the revolver. The attachment of a grip adapter will aid these persons in maintaining the proper grip. It is a commercially procured item, usually constructed of rubber or plastic and curved to conform to the contours of the stock, which is attached to the frame of the revolver as shown in figure 53. In effect, it enlarges the stocks of the revolver.

c. Two-Hand Grip. The two-hand grip is obtained as follows: Grip the revolver as prescribed in *b* above. Seat it firmly in the palm of the free hand. The fingers and thumb of the free hand

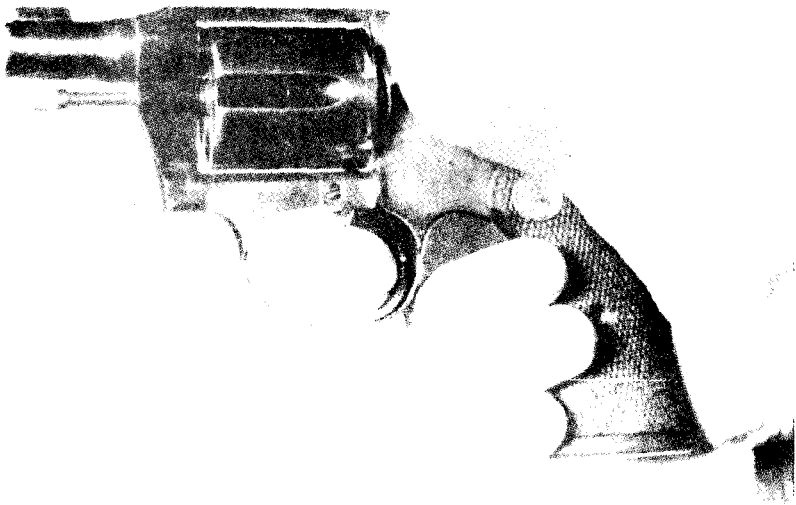

Figure 55. Conventional grip, caliber .38 revolver.

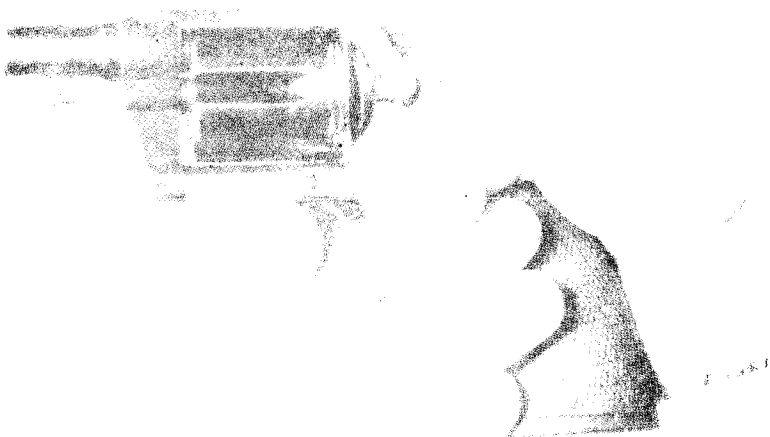

Figure 56. Alternate grip with thumb down, caliber .38 revolver.

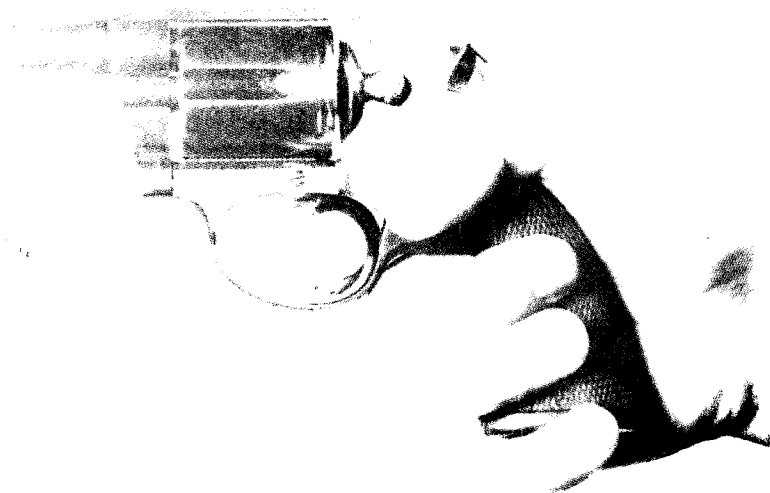

Figure 57. Alternate grip with little finger under butt, caliber .38 revolver.

are then closed over the firing hand in a manner that will provide maximum support (fig. 34).

d. Standing Position, Offhand. Paragraph 67d is applicable also to the use of the revolver in this position.

e. Prone Position. To assume the prone position (fig. 58), the



Figure 58. The prone position.

firer faces the target, draws his revolver from the holster, bends slightly forward at the waist, and drops to his knees. He then falls forward, breaking his fall with his free hand and arm and simultaneously pointing the revolver at the target with his firing hand and arm. He lies on the ground with his legs straight and feet together with his body as flat on the ground as possible. The chest and forearms should rest on the ground. He reaches out with his free hand and takes the two-hand grip on the revolver. If the firer is unable to aline the sights properly using the two-hand grip, he may form the free hand into a fist and support the revolver. The firer may then cock the weapon, aim, and squeeze the trigger.

Caution: When assuming any of the firing positions, do not place the trigger finger inside the trigger guard until the revolver is pointed toward the target.

f. Kneeling Position. To assume the kneeling position (fig. 59), the firer faces the target, draws his revolver from the holster, and drops to his right knee. His left knee is up and pointed toward the target. His right knee is on the ground about 4 inches behind the left heel. The weight of the body is distributed on the calf and heel of the right leg. His left elbow is projected beyond the knee, allowing the fleshy part of his arm to rest on the knee. The two-hand grip is taken on the revolver, and the right elbow and wrist are held straight and locked. The firer may then cock the revolver, aim, and squeeze the trigger.

g. Sitting Position. To assume the sitting position (fig. 60), the firer stands facing the target with the feet about 6 inches apart.

He then sits down, breaking his fall with his left hand and draws the revolver from the holster, swinging it widely to the right and forward. His knees are bent and his knees and feet are about 6 inches apart. Both elbows project beyond the knees, allowing the fleshy part of the arms to make contact with the knees. For the heavily built man, it may be necessary to place the fleshy part of the forearms on the knees. When the sitting position is first assumed and the revolver is not directly at eye level, the feet should be drawn closer to the body. This raises the knees and elevates the revolver. This procedure should be reversed if the revolver is too high. The firer then takes the two-hand grip on the revolver with his right wrist and elbow straight and locked. The firer may then cock the revolver, aim, and squeeze the trigger.

h. Standing Position (Behind Barricade, Right Hand). To assume the standing position behind the right side of a barricade (fig. 61), the firer places his left foot forward with the toe pointed to the right, at about a 45-degree angle, near the edge of the barricade. The right foot is placed to the rear of the left foot at a comfortable position. The left hand, palm open, is placed against the barricade, so that the forefinger (held along the edge of the barricade) and the thumb form an L. The firer leans slightly on the left arm so that the arm is stiff. He grips the revolver in his right hand, resting the right wrist on the left thumb, with the left thumb up against the wrist for a steadier rest. He keeps well



Figure 59. The kneeling position.



Figure 60. The sitting position.

behind the barricade, with only the revolver, right hand, left thumb, right temple, and the right eye visible from the other side of the barricade.

i. Standing Position (Behind Barricade, Left Side). The position for firing from the left side of the barricade is the same as for the right side except that the procedures in taking the position are reversed and the pistol is fired with the left hand.

j. Crouch Position, Point Fire. The firer approaches the firing point at double time. About 5 feet from the firing point, he slows to a walk and draws the weapon, keeping it pointed toward the target area. At the firing point he stops and bends the knees, crouching with the body bent forward at the hips, feet spread well apart, with the left foot slightly forward. He swings the weapon up to shoulder height, pointing it at the target as though pointing a finger. Keeping the arm locked in position, he quickly alines the sights and fires double action (fig. 62).

k. Hip Shooting. To execute the draw and fire from the hip (fig. 63), the firer does the following in one continuous motion: Assume a boxer's stance by bending the body forward at the waist and spreading the feet to obtain perfect balance. The left foot should be forward and the knees slightly bent. At the same time the firer assumes his stance, he grasps the revolver by the stock and draws it from the holster. As soon as the muzzle clears the holster, the forearm, hand, and revolver are pointed at the target, and the revolver is fired double action. The trigger finger should

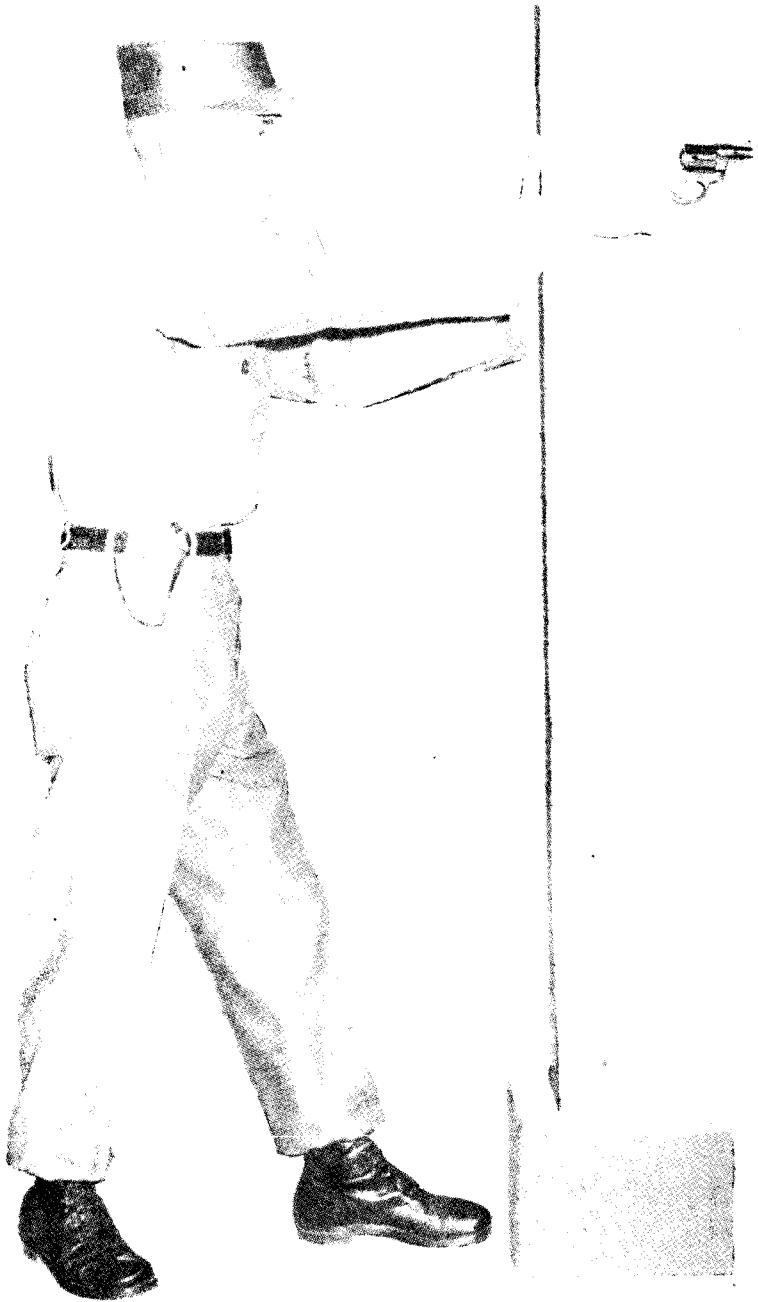

Figure 61. Standing position (behind barricade, right side).

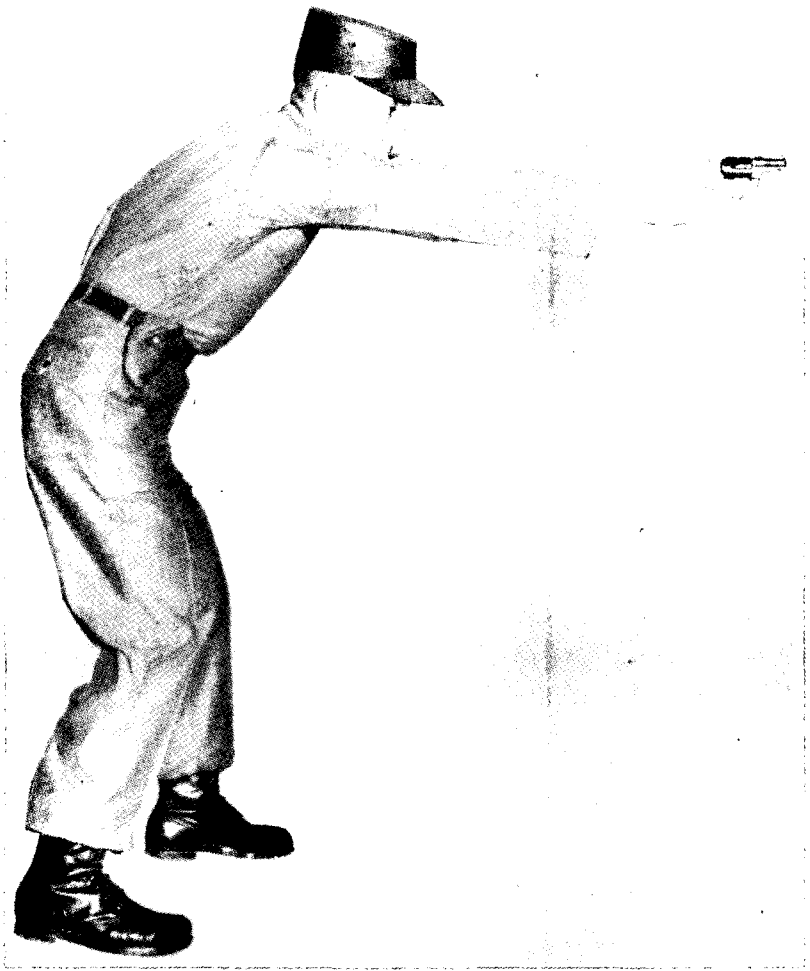

Figure 62. Crouch position, point fire.

not be inserted in the trigger guard, until the weapon points in the direction of the target. To improve hip shooting, the firer should practice before a mirror. Such practice will show him the direction in which the weapon is pointed and reveal any errors that he is making.

137. Position Exercises

Position exercises should be conducted as outlined in paragraph 68 for each position that is fired with the revolver.

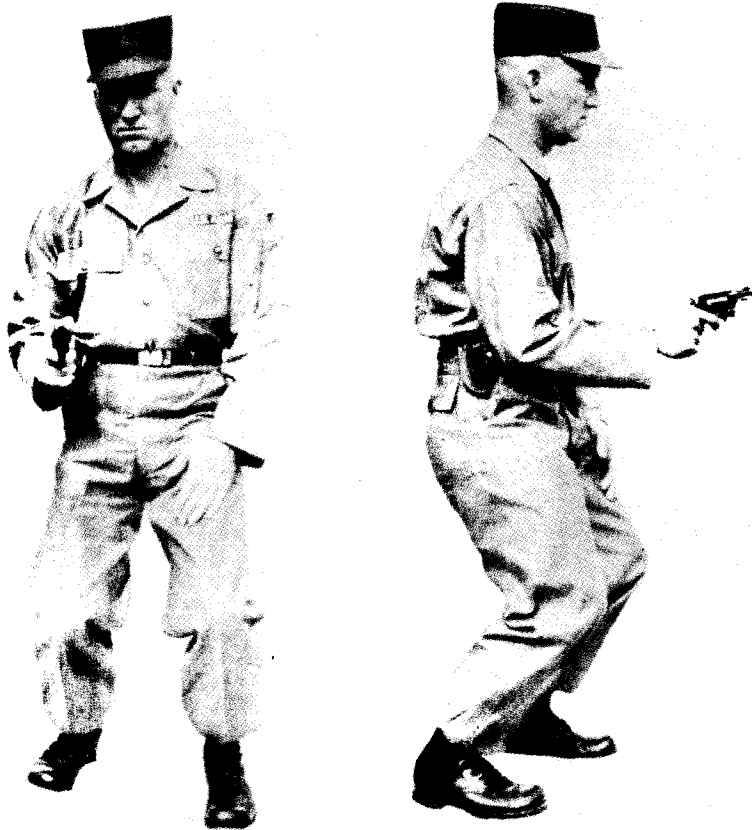

Figure 63. Hip shooting.

138. Trigger Squeeze and Trigger Squeeze Exercises

Paragraphs 69 and 70 apply also to the use of the revolver.

139. Slow Fire and Slow Fire Exercise

Paragraphs 71 and 72 apply also to the use of the revolver.

140. Rapid Fire

Paragraph 73 applies also to the use of the revolver.

141. Cocking the Revolver

a. General. To fire the revolver accurately during rapid fire, it is necessary for the firer to maintain uniformity of grip while

cocking the piece. A great deal of practice is necessary before sufficient skill is acquired to cock the hammer without shifting the position of the stock in the hand. The following method of gripping the revolver should be taught.

b. Straight-Back Method.

- (1) With this method of cocking the revolver (fig. 64), the grip is not loosened, and the revolver is not shifted from its line of sight. As soon as the shot is fired and while the gun recoils, the thumb is placed on the hammer spur and the hammer is drawn straight back to the full cock position by the action of the thumb. During the time the hammer is being drawn back, the revolver is lowered to the aiming position and the sights are alined on the target. As soon as the hammer is cocked, the thumb is replaced alongside the frame. This method has the following advantages:
 - (a) Cocking in this manner permits the grip to be uniformly maintained throughout firing.
 - (b) Since there is no side movement of the revolver during the process of cocking, the sights can be readily alined and brought back on the point of aim.
- (2) Some individuals may experience difficulty in keeping the grip in the same position on the revolver during the firing



Figure 64. Cocking the revolver.

of a string. In most cases, the hand tends to work higher on the stock, thus restricting the action of the thumb in cocking and making it necessary to change the grip on the revolver in the middle of the string. This difficulty may be overcome by using the alternate grip, so that the little finger is placed under the bottom of the butt of the stock.

142. Cocking Exercise

a. This exercise is held for the purpose of acquiring a smooth and rapid cocking operation.

b. Before being considered proficient, the man must be able to cock the revolver at least 10 times in 10 seconds. The cocking exercise should be emphasized during the first hour of rapid fire training. Thereafter, each pupil should be given additional practice from time to time until he is considered proficient.

c. The exercise is conducted using the coach-and-pupil method with the instructor explaining and demonstrating cocking. Emphasis is placed on the following points: the importance of maintaining a uniform grip, keeping the sights aligned on the target, and the necessity of keeping the eye focused on the sights. This exercise should not be continued longer than about 10 seconds at a time. Frequent changes of coach and pupil are necessary to prevent undue tiring of the muscles of the arm and hand. After requiring the pupil and his coach to take position on the line, the instructor commands—

- (1) COCKING EXERCISE—READY.
- (2) EXERCISE.
- (3) CEASE FIRING.
- (4) REST.

At the command COCKING EXERCISE—READY, the pupil grips the revolver as described in paragraph 136 and extends it to the firing position. At the command EXERCISE the eye is focused on the sights and the trigger is squeezed, causing the hammer to fall. Cocking the hammer by the prescribed methods is then continued until CEASE FIRING is given, then the revolver is brought to the position of raise pistol.

143. Rapid Fire Exercises

Paragraph 74 applies also to rapid fire with the revolver except for cocking the revolver with the thumb instead of using a cord on the hammer.

144. Quick Fire and the Quick Fire Exercise

Paragraphs 75 and 76 apply also to quick fire with the revolver. However, in table III the revolver is fired double action for the two rounds at the crouch position on the 10-meter line.

145. Examination Before Range Firing

Paragraph 77 applies also to the revolver.

Section III. COURSES FIRED

Note. Instruction practice and record firing courses applicable also for the revolver are described in paragraphs 78 through 80 and 82.

146. Practical Qualification Course

a. General. Practical qualification with the revolver is the attainment of a minimum designated score on a firing course designed to simulate the actual conditions under which the weapon will ordinarily be used.

- (1) The objective of the practical qualification course is to train personnel in the practical use of the revolver, to demonstrate the capabilities and limitations of the weapon, and to familiarize the firer in firing under conditions of stress. The course supplements known-distance range practice and develops the firer's ability to fire quickly, instinctively, and accurately, under varying conditions of stress.
- (2) Qualification in practical revolver shooting includes firing from several positions at varying ranges; shooting with the right and left hands; point firing, double action; and hip shooting. The course does not represent one continuing situation; it represents several possible situations that personnel armed with the revolver may encounter.

b. Prior Training Requirements.

- (1) Training in practical revolver firing should not begin until the individual has demonstrated a mastery of basic marksmanship training by attaining the score of marksman or higher in record firing (pars. 80, 85, and 86).
- (2) The firer should be in good physical condition, as qualification will depend in part on his ability to get into the prescribed positions quickly, move from one firing point to another rapidly, instinctively coordinate the movements of his body, and complete the course within the time prescribed.

147. Description of the Course

The practical qualification course is divided into two phases (fig. 65).

a. Phase I. The firer begins at the 55-meter line (the starting line) with 50 rounds of ammunition in his pocket and 5 rounds in the weapon. Once he begins the course, he continues until phase I is completed. He reloads with 5 rounds each time the weapon is empty. Time for this phase is 6½ minutes. The phase is outlined in table XI.

Table XI

Range (meters)	Point	Position	Rounds
50	1	Prone-----	5
50	2	do-----	5
40	3	Kneeling-----	5
40	4	do-----	5
30	5	Sitting-----	5
25	6	Standing (off hand)-----	5
25	7	Standing (behind right portion of barricade) -	5
25	8	Standing (behind left portion of barricade)---	5
25	9	Standing (off hand)-----	5
7	10	Crouch (point fire)-----	5

b. Phase II. The firer, with five rounds loaded in the revolver and with weapon in holster, enters a simulated room. The moment he sees the target, he draws his weapon as quickly as possible, and fires five rounds double action from the hip. Time limit for this phase is 5 seconds.

Section IV. RANGE FIRING AND SAFETY PRECAUTIONS

Note. Range firing procedure and safety precautions contained in paragraphs 83 through 86 and 88 pertain also to the revolver.

148. Procedure for Conducting Practice Firing on Practical Qualification Course

a. Purpose. The purpose of practice firing on the practical qualification course is to permit the firer to fire a modification of the course under competent close supervision, in order that any errors or bad firing habits may be detected and corrected. Practice firing will also determine if the firer is prepared to fire for qualification.

b. Conduct of Practice Firing.

- (1) Place an S target in the window of the house.
- (2) Load the revolver with 5 rounds and place 30 rounds in the pocket.
- (3) Stand at the starting point with the revolver in the holster.
- (4) At the command GO, double time to point 1 on the 50-meter line, assume the prone position, and fire five rounds. Clear and inspect the weapon and holster it.
- (5) Move forward with the instructor and inspect the target. The instructor will use this opportunity to critique the firer. The hits are then pasted so that subsequent hits may be determined.
- (6) Return to the 50-meter line, reload with 5 rounds, and assume the prone position. At the command GO, double time to point 3, on the 40-meter line, and repeat the procedure of (4) and (5) above, except that the firing will be from the kneeling position.
- (7) Repeat these procedures from the sitting position, point 5; standing (off hand), point 6; standing position (behind right side of barricade), point 7; and crouch position (point fire), point 10. Phase I is now completed.
- (8) For phase II, the firer enters the simulated room with the revolver loaded with 5 rounds of ammunition and holstered. Immediately upon seeing the target, the firer executes a quick draw and fires the 5 rounds double action at the target as quickly as possible.

149. Conduct of Record Firing on Practical Qualification Course

a. Phase I.

- (1) During record firing on the practical qualification course the instructor (coach) merely times the firer and follows him from point to point to insure that he complies with all safety regulations and fires from the correct firing points.
- (2) One S target is placed in the window, and one in the door of the house. The firer fires on the target in the window from all firing points on the right side of the course and on the target in the door from all firing points on the left side of the course.
- (3) To begin firing for record, the firer stands at the starting point with 5 rounds loaded in the holstered revolver.

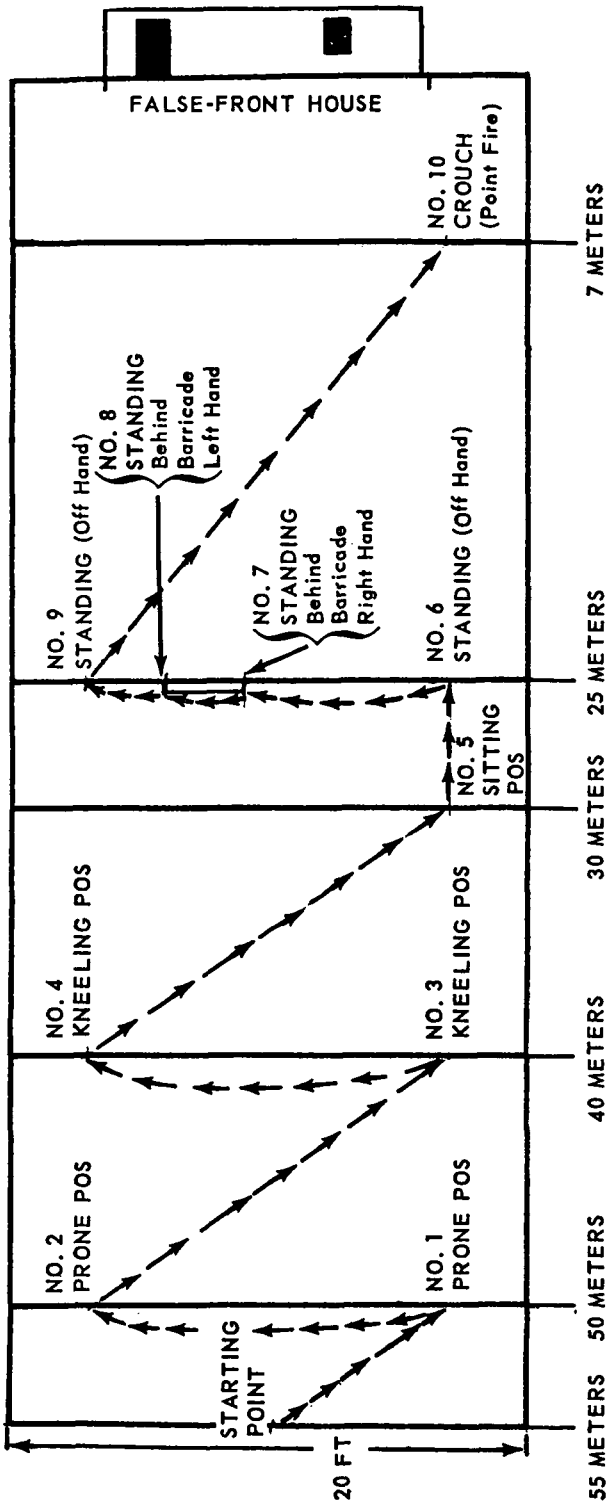

Figure 65. Practical qualification course.

When the instructor gives the command GO, he begins to time the firer.

Note. The revolver is loaded with 5 rounds and holstered at completion of firing at each firing point except at firing points 6 and 7.

- (4) At the command GO, the firer proceeds at double time to point 1, draws the revolver, assumes the prone position, takes the two-hand grip on the revolver and fires 5 rounds single action. He reloads while in the prone position, then moves at double time to point 2 and repeats the same procedure.
- (5) The firer double times to point 3, draws the revolver, assumes the kneeling position, fires 5 rounds single action, assumes the prone position, and reloads. He repeats the same procedure at point 4.
- (6) The firer proceeds at double time to point 5, draws the revolver, assumes the sitting position, and fires 5 rounds single action. He then assumes the prone position, reloads, and runs to point 6.
- (7) At point 6, the firer draws the revolver, assumes the standing position (off hand), and fires 5 rounds. Holding the revolver pointed downrange, the firer ducks behind the barricade to point 7.
- (8) At point 7, he reloads with 5 rounds and fires from behind the barricade, right side. He reloads and then moves to point 8, firing 5 more rounds from behind the barricade, left side.
- (9) He reloads the revolver while behind the barricade, then double times to point 9, draws the weapon, assumes the standing position (off hand), fires 5 rounds single action, and ducks back behind the barricade and reloads.
- (10) The firer then double times to point 10 and fires 5 rounds double action from the crouch position, point fire. This completes phase I and the instructor (coach) stops timing.

b. Phase II. To prepare for phase II, the instructor, out of sight of the firer, places the target in the simulated room behind the false-front house, 5 yards inside the door. The firer should not know the exact location of target.

- (1) The firer loads 5 rounds in the revolver and places it in the holster. He then proceeds through the door. At the instant he sees the target, he draws and fires 5 rounds double action as quickly as possible.
- (2) Timing starts as soon as the firer's hand moves toward the weapon and stops when the last round is fired.

150. Scoring and Classification

a. Phase I.

- (1) *Scoring.* Phase I must be completed within 6½ minutes. Regardless of the score attained, the firer has not qualified unless he completes the course in the allotted time. Hits are scored as 5, 4, 3, or 2, depending upon their location on the target. To compute the score, count the number of hits in each zone, multiply by the value of the zone and add the total. Misses are scored as zero.
- (2) *Classification.* Personnel will be qualified according to the following minimum scores, out of a total possible 250, provided that the course has been completed in the time allotted:

Expert	200
Sharpshooter	175
Marksman	150
Unqualified	Below 150 or exceeding 6½-minute time limit.

b. *Phase II.* To qualify in phase II, the firer must score at least 3 hits upon the target in 5 seconds. The position of the hits on the target is immaterial. Classification as outlined above is not confirmed unless the firer can achieve the requirements of phase II. Refiring of phase II will be continued until this standard is achieved, at which time classification based upon scores fired in phase I will be established.

151. Score Card

DA Form 88 (Individual Score Card—Caliber .45 Pistol and Caliber .38 Revolver) will be used.

152. Safety Precautions on the Range

- a. Never load the revolver until you have taken your place at the firing point and have received the command to load.
- b. Always clear the revolver before leaving the firing point.
- c. Always hold the loaded revolver at the position of *raise pistol* or *ready* except while aiming. If the arm becomes weary, transfer the weapon to the other hand, keeping it in the position of *raise pistol*.
- d. If one or more cartridges remain unfired at the end of a firing string, remove the cartridge and clear the revolver.
- e. When drawing the revolver from the holster, keep the muzzle from pointing at any portion of the body.

f. Always clear and inspect the revolver before practicing dry firing.

g. Make sure that the cylinder chambers and bore are clear of obstructions before firing.

h. On the range, always carry the revolver with the cylinder swung out from the frame when not on the firing line or when weapon is not holstered.

Section V. TARGETS AND RANGES

153. Targets

The S target is used in the practical qualification course (fig. 66). It is a black silhouette, representing a man firing a revolver, which is divided into several zones for scoring purposes. Hits within the zone are given the value of the zone as described in paragraph 150. Hits that touch a zone line are given the value of the higher zone. Use of other targets when firing the revolver is described in paragraph 90.

154. Construction of the Practical Qualification Range

a. General. The course is designed to allow for simplicity in construction so as to permit completion with a minimum of labor, materials, and expense. It may be built without the technical assistance of surveyors, artists, draftsmen, or carpenters. Scrap material is adequate, since no durability other than that necessary to withstand local weather hazards is required.

b. Selection of Site. The ground on which the range is built should be level, reasonably soft, and free from obstructions such as ditches, trees, or stumps. Safety requirements for construction of pistol ranges, applicable also to the revolver, are listed in TM 9-855.

c. Steps in Construction.

- (1) Measure an area $6\frac{2}{3}$ meters wide and 65 meters long. Place a stake at each corner and connect the stakes with string, making certain that area is exactly rectangular.
- (2) Clear the area of all grass, weeds, and other obstructions and rake it, so that the top soil is reasonably soft.
- (3) Place wooden stakes on each side of the cleared area at the following distances (fig. 65), beginning at the starting line and working in the direction of fire: 55 meters, 50 meters, 40 meters, 30 meters, 25 meters, and 7 meters.
- (4) Construct a wooden barricade 9 feet high by 3 feet wide, using available materials (fig. 67). Fasten it securely

NO. 2, 3, 4 NUMERALS 1-1/2 INCHES WIDE X
 1-3/4 INCHES HIGH 1/8 INCHES THICK. NO. 5
 NUMERAL 1-3/4 INCHES WIDE X 2 INCHES HIGH
 1/4 INCHES THICK.

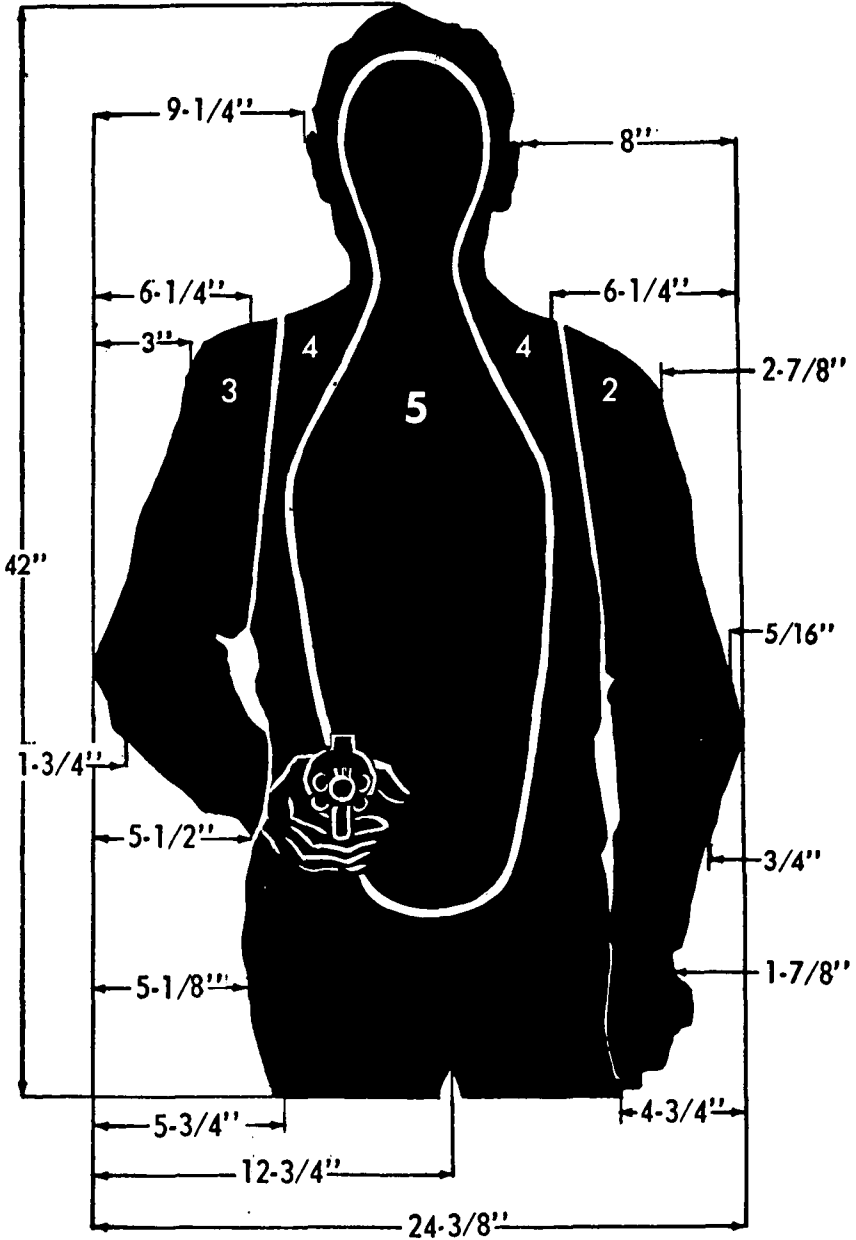

Figure 66. S target.

with wooden braces, making sure that the braces are on the side of the barricade toward the target. Place the barricade in the center of the firing lane on the 25-meter line so that it cannot be accidentally moved by the firer.

- (5) Construct 11 rectangular signs, 18 inches wide by 12 inches high; paint them white, and letter them with 2-inch black letters as follows:

STARTING POINT	POINT 1	POINT 2
55 Meters	Prone	Prone
	50 Meters	50 Meters
POINT 3	POINT 4	POINT 5
Kneeling	Kneeling	Sitting
40 Meters	40 Meters	30 Meters
POINT 6	POINT 7	POINT 8
Standing—Off Hand	Barricade—Right	Barricade—Left
25 Meters	Side—25 Meters	Side—25 Meters
	POINT 9	POINT 10
	Standing—Off Hand	Crouch—Point
	25 Meters	Fire—7 Meters

- (6) Nail all the signs (except those for points 7 and 8) to suitable stakes and set them securely in the ground at each of the firing points, as shown in figure 65. The signs should be located about 1 yard from the left and right sides of the firing lane. Be sure that the signs can be read from the appropriate firing position. Nail the signs for points 7 and 8 to the appropriate side of the barricade about 2 yards above the ground.
- (7) Construct two portable wooden target stands, with back braces, from available materials, according to the specifications shown in figure 68.
- (8) Construct a false-front for a house, representing an open door and an open window, according to specifications shown in figure 69. Place the false front in position at the end of the firing lane as shown in figure 65.

d. Firing Lanes. Ordinarily, 1 firing lane will be sufficient to accommodate the average unit armed with the caliber .38 2-inch barrel revolver. However, 2 additional lanes may be constructed on this range at about 45 degree angles from the center lane. If additional lanes are constructed, careful consideration must be given to the safety requirements.

e. Construction of Other Ranges. Construction of targets and other ranges is described in paragraphs 90 and 91.

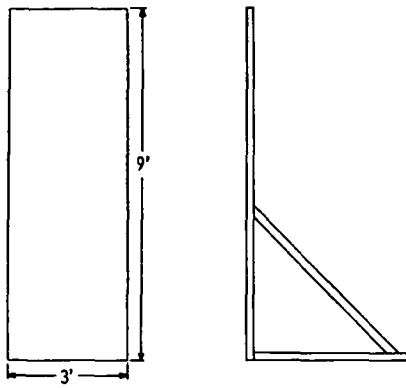

WOOD BARRICADE
WITH BRACES IN BACK

Figure 67. Specifications for wooden barricade.

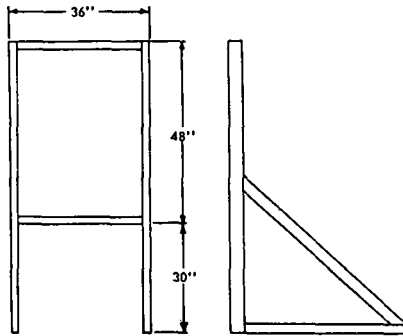

TARGET STAND
BRACES TO BE FASTENED IN BACK OF TARGET STAND

Figure 68. Specifications for target stands.

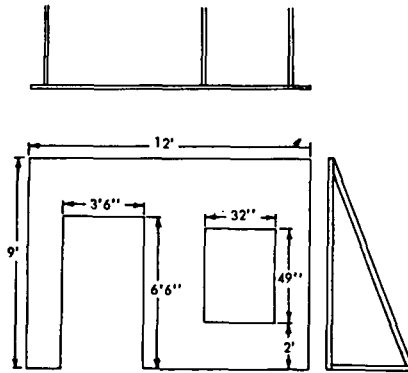

BUILDING FRONT
BRACES TO BE PLACED BEHIND BUILDING FRONT

Figure 69. Specifications for false-front house.

CHAPTER 10

ADVICE TO INSTRUCTORS

Section I. GENERAL

155. General

Refer to paragraphs 92 through 94, 96 through 99, and 101 through 103 for general instructions, mechanical training, and marksmanship. Training schedules are shown in paragraphs 156 and 157.

Section II. TRAINING SCHEDULES

156. Minimum Subject Schedule, Familiarization Course, Revolver, Caliber .38 (8 hours)

Period	Hour	Subject	Text references	Area	Training aids and equipment
1	1	General characteristics; immediate action, care and cleaning; load, fire, unload.	FM 23-35, pars. 110, 111, 113-115, 118-127.	Classroom or field	1 revolver per man; 1 table or shelter half per 4 men.
2	3	Preparatory marksmanship, aiming, positions, trigger squeeze, slow and quick fire exercises.	FM 23-35, pars. 136-142, 144--	Pistol range or field.	Training aids and equipment as listed in pars. 65-70.
3	4	Range firing -----	FM 23-35, pars. 81, 87, 89, and 148. AR 370-5, AR 385-63.	Pistol range -----	Range equipment: 1 revolver per firer; 25 rd ammo, 1 score card, 1 E target (group of 3) per firing point.

157. Minimum Subject Schedule, Qualification Course, Revolver, Caliber .38 (16 hours)

Period	Hours	Subject	Text references	Area	Training aids and equipment
1	4	General characteristics, loading, unloading. Immediate action, malfunctions, and stoppages. Care and cleaning, accessories, ammunition, individual safety precautions.	FM 23-35, pars. 110-131-----	Classroom or out-door training area.	1 revolver per man; 1 table or shelter half per 4 men. Cleaning rod, bore brush, oil, bore cleaner, swabs, all accessories listed in par. 128. Various types of ammunition listed in par. 129.
2	2	Preparatory marksmanship, aiming, position exercises, trigger squeeze exercises.	FM 23-35, pars. 60-66, 136-138	Pistol range or field.	Training aids and equipment as listed in pars. 65-70.
3	1	Preparatory marksmanship; slow, rapid, and quick fire exercises.	FM 23-35, pars. 139-144-----	Pistol range or field.	Same as period 2.
4	1	Review and examination -----	FM 23-35, par. 145 and all previous references.	-----do-----	All equipment used in preceding periods.
5	4	Instruction practice firing -----	FM 23-35, pars. 79, 85, 89-----	Pistol range-----	Range equipment; 40 rd ammo, 1 revolver, 1 score card, dummy cartridges for each firer; 1 25-yard (std American) pistol target and one E target (group of 3) per firing point.

Period	Hours	Subject	Text references	Area	Training aids and equipment
6	4	Record firing or firing practical qualification course.	FM 23-35, pars. 80, 86, 89, 149	Pistol range -----	<p>Range equipment; 40 rd ammo, 1 score card, dummy cartridges for each firer; 1 25-yard (std American) pistol target and E target (group of 3) per firing point.</p> <p>(Note. If practical course is fired, the S target will be used and 55 rounds of ammunition will be required.)</p>

APPENDIX

REFERENCES

1. Regulations

- AR 320-5.....Dictionary of United States Army Terms.
AR 320-50.....Authorized Abbreviations and Brevity Codes.
AR 370-5.....Qualification and Familiarization.
AR 385-63.....Regulations for Firing Ammunition for
Training, Target Practice, and Combat.

2. Field Manuals

- FM 21-5.....Military Training.
FM 21-6.....Techniques of Military Instruction.
FM 21-40.....Small Unit Procedures in Atomic, Biological,
and Chemical Warfare.

3. Technical Manuals

- TM 3-220.....Decontamination.
TM 9-855.....Targets, Target Material, and Training
Course Lay-outs.
TM 9-1007.....Materials Used for Cleaning, Preserving,
Abrading, and Cementing Ordnance Ma-
teriel and Related Materials, Including
Chemicals, Lubricants, Indicators and Hy-
draulic Fluids.
TM 9-1990.....Small Arms Ammunition.
TM 9-2027.....Caliber .38, Special Lightweight Revolver,
M13 (Colt and Smith and Wesson).
TM 9-2200.....Small Arms Materiel and Associated Equip-
ment.
TM 9-2205.....Fundamentals of Small Arms.
TM 9-2951-1.....Field Maintenance, Caliber .45 Automatic
Pistols, M1911 and M1911A1.

4. Miscellaneous

- ASubjScd 21-33.....Pistol, Automatic, Caliber .45, M1911 and
M1911A1.
DA Pam 108-1.....Index of Army Motion Pictures, Film Strips,
Slides, and Phono-Recordings.

DA Pam 310-series__Military Publications (Indexes).

ORD 7, SNL B6_____Pistols, Automatic, Caliber .45, M1911 and
M1911A1.

ORD 7, SNL B29_____Revolver, Colt, Caliber .38, 2-inch Barrel,
Detective Special.

INDEX

	Paragraphs	Pages
Accessories:		
Pistol	49	40
Revolver	128	118
Action of sear and disconnecter	30	29
Advice to instructors	92-109, 155-157	92, 143
After-fire care and cleaning:		
Pistol	44	38
Revolver	126	117
After-storage cleaning	47	39
Aids, training	107-109	102
Aiming (<i>See</i> Sighting and aiming)		
Ammunition		
Care, handling, and preservation	50	40
Classification, caliber .45	53, 131	41, 119
caliber .38	51	40
Hangfire	130	118
Lot number	56	42
Precaution in firing	52	41
Precaution in firing	55	42
Assembly, pistol		
Guides to follow	11	8
Magazine	8	7
Receiver group	16	15
Receiver group	18	16
Slide group	17	16
Test for correct	19	21
Before-firing care and cleaning:		
Pistol	43	37
Revolver	125	117
Biological attack, care and cleaning:		
Pistol	46	39
Revolver	127	118
Blackening sights	84	76
Card, score:		
Pistol	80	74
Revolver	151	138
Care and cleaning:		
After firing:		
Pistol	44	38
Revolver	126	117
Before firing:		
Pistol	43	37
Revolver	125	117
CBR attack:		
Pistol	46	39
Revolver	127	118

	Paragraphs	Pages
Care and cleaning—Continued		
From storage	47	39
Unusual climatic conditions	45	38
Care of ammunition	53, 131	41, 119
Cause of stoppages:		
Pistol	38	33
Revolver	120	115
Chambering	23	27
Charts	109	107
Chemical attack, care and cleaning:		
Pistol	46	39
Revolver	127	118
Classification of ammunition:		
Caliber .45	51	40
Caliber .38	130	118
Cleaning materials	41	36
Coaching	64	51
Cocking:		
Pistol	29	28
Revolver	141	130
Cocking exercise, revolver	142	132
Construction:		
Ranges	91, 154	89, 139
Wooden working model	108	103
Courses:		
Familiarization, pistol	81	74
Instruction practice, pistol	79	73
Practical qualification, revolver	146, 147	133, 134
Record firing:		
Pistol	80	74
Revolver	149	135
Specialized firing	82, 88	75, 83
Daily maintenance:		
Pistol	42	37
Revolver	124	117
Data:		
Pistol	5	6
Revolver	111	109
Description:		
Magazine	3	4
Pistol	3	4
Practical qualification course	147	134
Revolver	110	109
Detail disassembly, pistol	12-15	13
Devices, safety:		
Pistol	31	29
Revolver	116	114
Difference in pistol models	4	4

	Paragraphs	Pages
Disassembly:		
Guides.....	8	7
Pistol:		
Detail.....	12-15	13
General.....	9, 10	7, 8
Magazine assembly.....	15	13
Receiver group.....	13	13
Slide group.....	14	13
Revolver.....	112	112
Disconnecter:		
Action.....	30	29
Test.....	32	30
Ejection.....	28	28
Examination.....	77	71
Exercises:		
Aiming.....	66	53
Cocking, revolver.....	142	132
Pencil triangulation.....	70	64
Position:		
Pistol.....	68	60
Revolver.....	137	129
Quick fire:		
Pistol.....	76	70
Revolver.....	144	133
Rapid fire:		
Pistol.....	74	68
Revolver.....	143	132
Slow fire, pistol.....	72	65
Trigger squeeze:		
Pistol.....	70	64
Revolver.....	138	130
Extraction.....	27	28
Failures:		
Pistol.....	38	33
Revolver.....	120	115
Familiarization course.....	81	74
Procedure for conducting.....	87	82
Feeding.....	22	25
Firing:		
Familiarization.....	81	74
Instruction practice.....	79	73
Pistol.....	34	30
Practical qualification.....	146, 147	133, 134
Record:		
Pistol.....	80	74
Revolver.....	149	135
Revolver.....	114	112
Specialized.....	82, 88	75, 83
Functioning, pistol.....	20-30	24
Fundamentals of marksmanship.....	61	50

	Paragraphs	Pages
Gas attack, care and cleaning:		
Pistol.....	46	39
Revolver.....	127	118
General data:		
Pistol.....	5	6
Revolver.....	111	109
General disassembly, pistol.....	9, 10	7
Grip:		
One-hand:		
Pistol.....	67	54
Revolver.....	136	122
Two-hand:		
Pistol.....	67	54
Revolver.....	136	122
Grip adapter, revolver.....	110	109
Grip safety test.....	32	30
Guides for disassembly and assembly.....	8	7
Half-cock-notch test.....	32	30
Handling of ammunition.....	53, 131	41, 119
Hangfire.....	56	42
Immediate action:		
Pistol.....	39	35
Revolver.....	121	116
Importance of training.....	2	3
Individual safety precautions.....	99	95
Inspection arms:		
Pistol.....	58	44
Revolver.....	134	120
Instruction practice firing course.....		
Organizing and conducting.....	79	73
Organizing and conducting.....	85	76
Instructors, advice.....		
Accessories.....	92-109	92
Accessories.....	98	95
Care and cleaning.....	96	94
Disassembly and assembly.....	95	94
Load, fire, and unload.....	97	94
Manual of arms.....	100	95
Marksmanship.....	101, 102	96
Method of instruction.....	93	92
Range firing.....	103	97
Safety precautions.....	99	95
Training aids.....	107-109	102
Training schedules.....	105-106,	99,
	156, 157	144
Loading:		
Pistol.....	33	30
Revolver.....	113	112
Locking.....	24	27
Lot number, ammunition.....	52	41
Lubricants.....	41	36

	Paragraphs	Pages
Magazine:		
Assembly.....	16	15
Description.....	3	4
Disassembly.....	15	13
Maintenance, daily.....	42	37
Malfunctions:		
Pistol.....	37	33
Revolver.....	119	114
Manual of arms, pistol.....	57	44
Inspection arms.....	58	44
Return pistol.....	59	49
Manual of arms, revolver.....	132	120
Inspection arms.....	134	120
Raise revolver.....	133	120
Return revolver.....	135	121
Marksmanship (<i>See also</i> Firing and exercises):		
Fundamentals.....	61	50
Phases of training.....	62	50
Materials, cleaning.....	41	36
Models:		
Differences.....	4	4
Wooden working.....	108	103
Nomenclature, pistol.....	7	7
Number, ammunition lot.....	52	41
Oil, lubricating.....	41	36
Operational tests, pistol.....	32	30
Parts, repair:		
Pistol.....	48	39
Revolver.....	128	118
Pencil triangulation exercise.....	70	64
Phases of training.....	62	50
Pistol:		
Accessories.....	49	40
Assembly.....	11	8
Data.....	5	6
Description.....	3	4
Disassembly.....	6, 9, 10	7
Functioning.....	20-30	24
Loading.....	33	30
Malfunctions.....	37	33
Nomenclature.....	7	7
Repair parts.....	48	39
Stoppages.....	38	33
Training, importance.....	2	3
Positions:		
Pistol.....	67	54
Revolver.....	136	122
Practical qualification course, revolver.....	146, 147	133, 134
Procedure for conducting.....	148	134
Range construction.....	154	139
Precautions in firing ammunition.....	55	42

	Paragraphs	Pages
Preparatory marksmanship	102	96
Preservation of ammunition	53, 131	41, 119
Procedures for organizing and conducting:		
Familiarization firing	87	82
Instruction practice firing	85	76
Record firing	86	80
Specialized firing	88	83
Qualification scores:		
Pistol	80	74
Revolver	150	138
Quick fire:		
Pistol	75, 76	69
Revolver	144	133
Radiological attack, care and cleaning:		
Pistol	46	39
Revolver	127	118
Raise pistol	58	44
Raise revolver	133	120
Return revolver	135	121
Range:		
Construction	91, 154	89, 139
Firing	85-88, 103, 148, 149	76, 97, 134
Responsibility during firing	83	76
Safety precautions	89, 152	87, 138
Rapid fire:		
Pistol	73, 74	67
Revolver	140, 143	130
Receiver group, pistol:		
Assembly	18	16
Disassembly	13	13
Record firing course	80	74
Repair parts:		
Pistol	48	39
Revolver	128	118
Responsibility, range firing	83	76
Return pistol	59	49
Revolver:		
Cocking	141	130
Data	111	109
Description	110	109
Disassembly	112	112
Fire	114	112
Immediate action	121	116
Load	113	112
Malfunctions	119	114
Repair parts and accessories	128	118
Safety devices	116	114
Stoppages	120	115
Unload	115	113

Safety devices:		
Pistol	31	29
Revolver	116	114
Tests of:		
Pistol	32	30
Revolver	117	114
Safety lock test	32	30
Safety precautions:		
Pistol	89	87
Revolver	152	138
Score card:		
Pistol	80	74
Revolver	151	138
Scoring:		
Pistol firing	86	80
Revolver firing	146	133
Sear action	30	29
Sighting and aiming	65, 66	52
Sights, blackening	84	76
Slide group:		
Assembly	17	16
Disassembly	14	13
Slow fire:		
Pistol	71	65
Revolver	139	130
Steps in functioning	20	24
Stoppages:		
Pistol	38	33
Revolver	120	115
Storage:		
Ammunition	54	42
Removal	47	39
Table:		
Familiarization firing, pistol	81	74
Instruction practice firing, pistol	79	73
Practice qualification firing, revolver	147	134
Record firing, pistol	80	74
Specialized firing	88	83
Targets:		
Pistol	90	88
Revolver	153	139
Tests:		
Correct assembly	19	21
Operational	32	30
Safety devices:		
Pistol	32	30
Revolver	117	114

Training:		
Aids.....	107-109	102
Importance.....	2	3
Marksmanship.....	60-62	50
Schedules.....	105, 106, 156, 157	99, 144
Trigger squeeze:		
Pistol.....	69, 70	62
Revolver.....	138	130
Unloading:		
Pistol.....	35	32
Revolver.....	115	113
Unlocking.....	26	28
Wooden working model.....	108	103

BY ORDER OF THE SECRETARIES OF THE ARMY AND THE AIR
FORCE:

L. L. LEMNITZER,
*General, United States Army,
Chief of Staff.*

OFFICIAL:

R. V. LEE,
*Major General, United States Army,
The Adjutant General.*

THOMAS D. WHITE,
Chief of Staff, United States Air Force.

OFFICIAL:

J. L. TARR,
*Colonel, United States Air Force,
Director of Administrative Services.*

Distribution:

Active Army:

Tech Stf, DA (1)	USMA (30)
Tech Stf, Bd (1)	PMGS (500)
USCONARC (25)	USASCS (110)
US ARADCOM (2)	USA Ord Sch (70)
US ARADCOM Rgn (2)	USAES (20)
Armies (10) except	USAIS (1104)
First US Army (12)	USAARMS (600)
Corps (5)	USA Corps (Res) (1)
Div (8)	Units org under fol TOE:
Log Comd (5)	7-11 (5)
Bn (5)	7-31 (5)
Co (3)	

NG: State AG (3); units—same as Active Army except allowance is two copies to each unit.

USAR: Same as Active Army except allowance is two copies to each unit.

For explanation of abbreviations used, see AR 320-50.