

RESTRICTED

The information given in this document is not to be communicated, either directly or indirectly, to the Press or to any person not authorized to receive it.

**ARMY
CODE NO**

70373

26/GS Training Publications/2843

Infantry Training

Volume I

INFANTRY PLATOON WEAPONS PAMPHLET No. 8

THE LIGHT MORTAR (2-inch) AND ILLUMINANTS

1966

Reprinted with Amendments (Nos.1-10), 1980

This Pamphlet supersedes Infantry Training Volume I, Infantry Platoon Weapons Pamphlet No. 8, The Light Mortar (2-inch), 1959 (Army Code No. 9547).

*Prepared under the direction of
The Chief of the General Staff*

October, 1966

Crown Copyright Reserved

CONTENTS

	<i>Page</i>
Introduction	1
CHAPTER 1—Instructional	
Lesson 1. Cleaning, servicing, bombs	2
Lesson 2. Loading, unloading and firing	9
Practice. Lessons 1 and 2	16
Lesson 3. The employment of smoke and illuminating bombs ...	17
CHAPTER 2—The High Explosive (HE) Bomb	
CHAPTER 3—Additional Information for Instructors	
Section	25
1. Characteristics and technical detail	27
2. Range work and safety rules	30
3. Practice periods	34
4. Methods of practice in laying smoke screens	35
5. Training tests	35
APPENDIX	
A. Details of training tests	37
B. Signal kit pyrotechnic pistol 16mm (miniflare)	51
CHAPTER 4—The Tripflare	
CHAPTER 5—The 1·5-inch Rocket Flare	
LIST OF ILLUSTRATIONS	
Figure	
1. The light mortar	iv
2. Taking off the barrel	4
3. Slackening the firing hole bush fixing screw	5
4. Contents of holdall	7
5. Smoke, illuminating and HE bombs	8
6. Loading	11
7. Unloading	12
8. High and low angle	13
9. Use of smoke in a cross wind	20
10. Use of smoke in a following wind	20
11. Use of smoke for flank screening	21
12. The HE bomb	24
13. The smoke bomb (mechanism)	26
14. The illuminating bomb (mechanism)	28
15. The mechanism of the No. 161 fuze	29
16. A tripflare set up	46
17. The flare pot unarmed	47
18. The flare pot armed	48
19. The 1·5-inch rocket flare	49
20. The signalling kit	53
21. The pistol	54

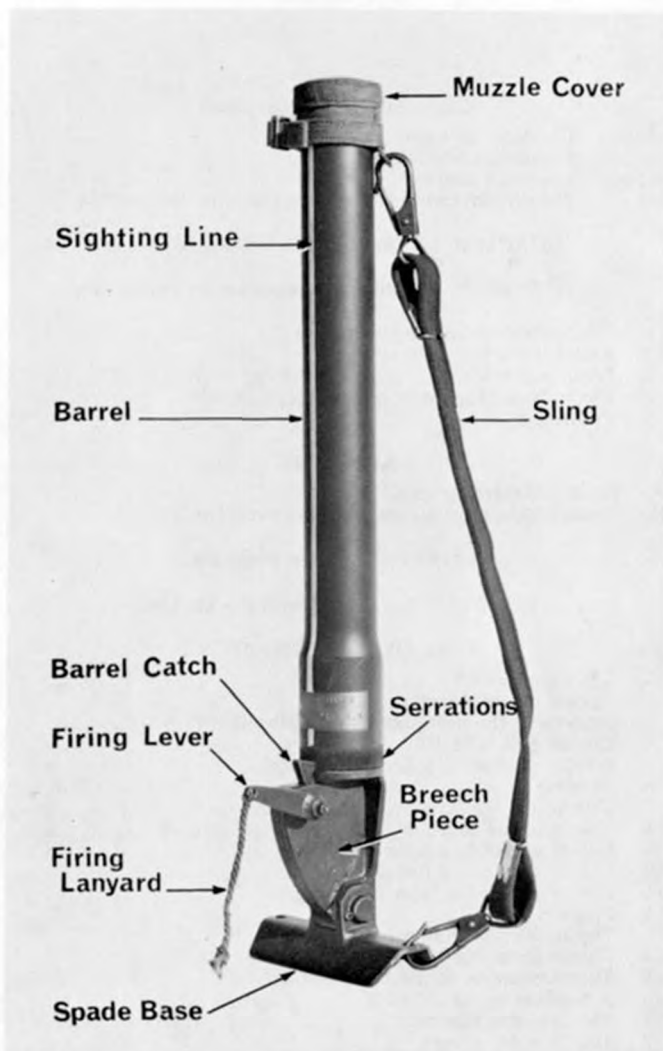

Fig. 1—The light mortar

Infantry Training

Volume I

INFANTRY PLATOON WEAPONS

PAMPHLET No. 8

The Light Mortar (2-inch) and Illuminants

1966

INTRODUCTION

The aim of weapon training

1. The aim of all weapon training is to produce soldiers who can use platoon weapons to maximum effect in battle.

Achievement of the aim

2. To achieve this aim the men must reach a high standard of accuracy, servicing and fieldcraft with all weapons and they must be able to work together as teams under good junior leaders.

Aim of this pamphlet

3. This pamphlet contains the material which an instructor needs to know to teach soldiers how to look after and handle the mortar correctly and how to use smoke, illuminating and, when necessary, HE bombs, effectively. There is also instruction in the tripflame and the 1·5-inch rocket flare.

Layout

4. The pamphlet comprises five chapters:—

- (a) Chapter 1 contains lessons which teach soldiers all they need to know, a practice period to drive home the skills and techniques and, above all, a section on live firing.
- (b) Chapter 2 contains the material necessary to teach the use of the high explosive (HE) bomb.
- (c) Chapter 3 contains more information to help instructors to understand the subject and its presentation better and tests to show the standard men have reached.
- (d) Chapter 4 contains information necessary for the setting up and arming of a tripflame.
- (e) Chapter 5 contains the material required for the instructor to teach the characteristics, firing and safe handling of the 1·5-inch rocket flare.

5. Throughout Chapters 1, 4 and 5 two forms of printing are used.

- (a) Those portions printed in ordinary type are notes for instructors.

- (b) The portions printed in italics contain the information and instructions to be taught to the men.

Method of instruction

6. (a) The subject matter should be taught in the sequence laid down in this pamphlet.
- (b) The practice period should be repeated according to progress made.
- (c) Instructors are allowed latitude in the method they use in teaching the various lessons and exercises during practice. Their aim must be to teach in the most interesting way possible without deviating from the facts and drills laid down.
- (d) All instructors should study the pamphlet, *Successful Instruction*, 1951 (WO Code No. 8670).

Method of training

7. The soldier must first learn how to clean and maintain the mortar and how to handle the mortar and bombs with safety. He then learns the basic skills of handling and firing, and is taught, and shown, the tactical use of smoke and illuminating bombs. Thereafter his training should be of a practical nature, firing smoke bombs tactically by day and illuminating bombs by night.

8. The additional training required for HE bombs will be carried out in the theatre in which HE bombs are used.

CHAPTER 1—INSTRUCTIONAL

LESSON 1—CLEANING, SERVICING, BOMBS

Aim

9. To introduce the mortar and its bombs and to teach how to strip, assemble and clean the weapon.

Stores

10. Mortars, cleaning kit in holdalls, mechanism wrench, drill bombs, diagram of mortar bombs.

Notes

11. (a) Emphasis should be laid on the simplicity of the mortar and on the ease with which it can be handled.
- (b) If the HE bomb is being taught, *see* Chapter 2.

Preliminaries

12. Inspect all mortars, drill bombs, bomb containers, pouches, chests to make sure that there are no live or practice inert bombs (see paras 26 to 29). Only drill bombs must be used during Lessons 1 and 2 and practice periods (see paras 26 to 29).

Approach

13. *This is the light 2-inch mortar. It is a simple weapon, used to fire smoke, HE and illuminating bombs. Its maximum range with smoke bombs is 525 yards (481 metres). One man can handle and fire the mortar; other men are required to carry the bombs.*

Stripping and assembling

14. Explain and demonstrate paras 15 and 16.

15. *To strip the mortar:—*

- (a) *Remove the sling and muzzle cover.*
- (b) *See that the mortar is empty. Pull back the barrel catch, and unscrew the barrel anti-clockwise until it is free (see Fig 2).*
- (c) *Using the combination tool, a screwdriver or a small coin, unscrew the steel pad fixing screw by two turns only (see Fig 3).*
- (d) *Lift off the steel pad and remove the firing pin and spring.*
- (e) *Do not strip further than this.*

16. *To assemble the mortar:—*

- (a) *Replace the firing pin, spring and steel pad.*
- (b) *Screw up the steel pad fixing screw.*
- (c) *Pull back the barrel catch and place the barrel on to the breech piece. First, turn the barrel in an anti-clockwise direction to seat the threads; then turn it clockwise until the barrel is fully screwed into place.*
The white line on the barrel will then be in line with the barrel catch. On some mortars it will be found that either the breech piece or the barrel have interrupted threads. In no circumstances are a breech piece and barrel both of which have interrupted threads to be assembled together.
- (d) *Replace the sling and muzzle cover.*

17. Practise the men in stripping and assembling.

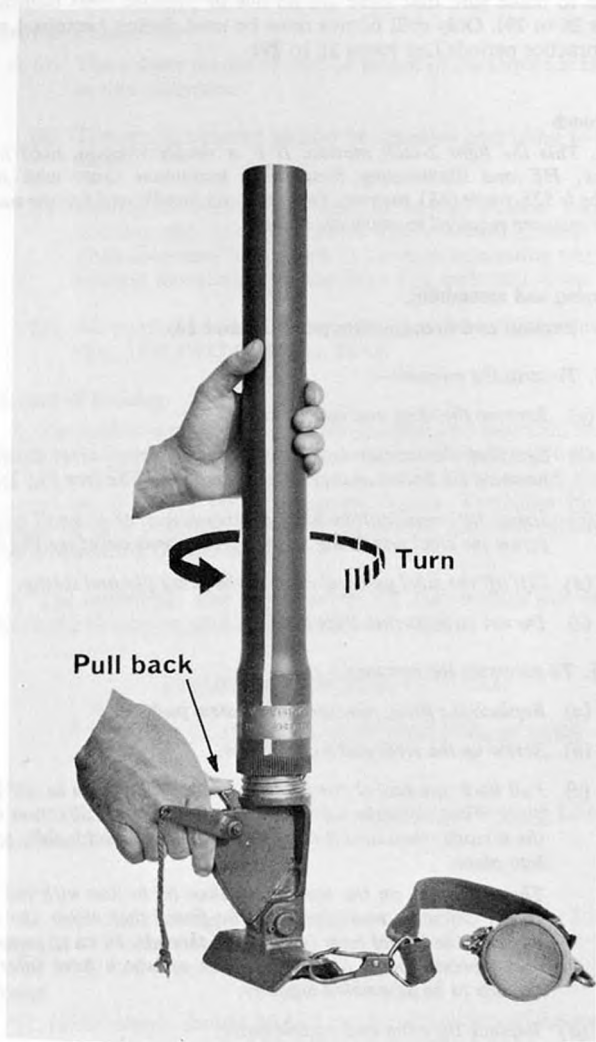

Fig 2.—Taking off the barrel

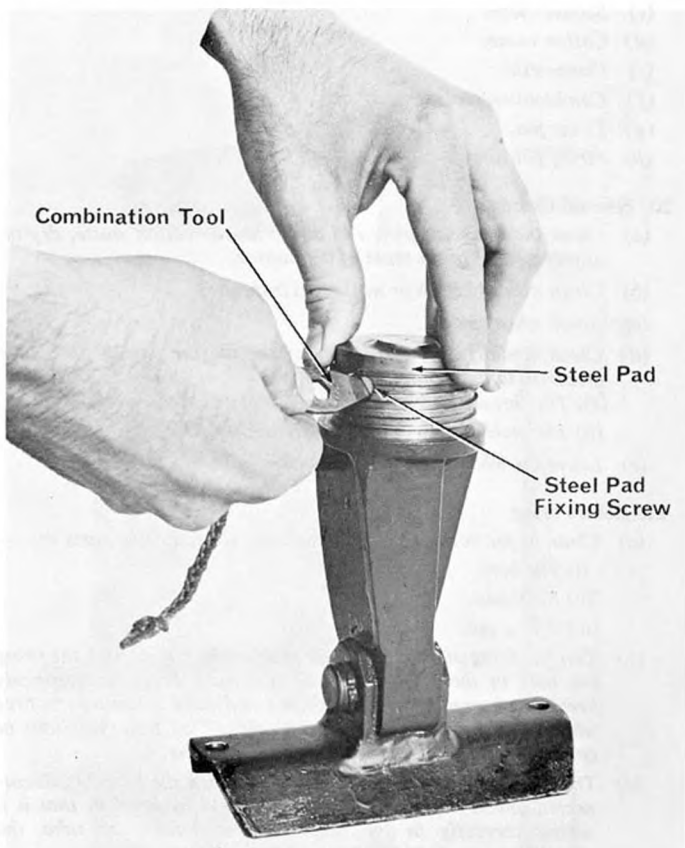

Fig 3.—Slackening the firing hole bush fixing screw

Care, cleaning and servicing

18. Explain and demonstrate paras 19 to 23.

19. *In the field or on training, the mortar must be cleaned daily; if in store at least once a week. Each mortar has a holdall which contains the following cleaning stores and spares (see Fig 4):—*

- (a) *Barrel cleaning brush and rod.*
- (b) *Oil can.*

- (c) *Sponge cloth.*
- (d) *Cotton waste.*
- (e) *Flannelette.*
- (f) *Combination tool.*
- (g) *Firing pin.*
- (h) *Firing pin spring.*

20. Normal cleaning

- (a) *Clean the bore using the rod and brush or cotton waste, dry or oily according to the state of the mortar.*
- (b) *Clean with dry cloth or waste and inspect.*
- (c) *Re-oil when clean.*
- (d) *Clean similarly the remainder of the mortar paying particular attention to these parts:—*
 - (i) *The threads on barrel and breech piece.*
 - (ii) *The steel pad, firing pin and spring.*
- (e) *Leave the whole mortar slightly oiled.*

21. Before firing

- (a) *Clean as for normal cleaning but leave the following parts dry:—*
 - (i) *The bore.*
 - (ii) *Steel pad.*
 - (iii) *Firing pin.*
- (b) *Test the firing pin and spring by pushing the pin through the firing pin hole in the steel pad. This test must be done thoroughly because a burred firing pin may jam and cause a bomb to be fired when it is dropped down the barrel. This test must also be carried out with the spare firing pin and spring.*
- (c) *The firing lanyard must not be pulled when the barrel is disconnected unless the steel pad is firmly held by hand so that it is seated correctly in the breech piece. Failure to take this precaution may lead to a broken firing pin.*

22. During firing

Whenever possible take off the barrel and clear the fouling from the steel pad. An excess of fouling on the pad will cause misfires.

23. After firing

Clean as for normal cleaning, paying particular attention to the bore, steel pad, firing pin and spring. Clean and oil for several days after firing.

24 Practise and question the men in care, cleaning and servicing.



Fig 4.—Contents of holdall

Bombs and carriage (see Fig 5)

25. Explain and demonstrate paras 26 to 30.

26. *Smoke bombs have a green body, white metal unpainted tail and a red band near the head. On the head there are three raised rivets and there may be a small metal lifting strap. They have the name, lot number and date of manufacture painted on the body.*

There is a cartridge in the tail which propels the bomb and ignites the smoke composition.

27. *Illuminating bombs have a white body, white metal unpainted tail and a red band near the head. On the head is a raised letter "P" for night identification. The name, mark, lot number and date of manufacture are painted on the body. There is a cartridge in the tail which propels the bomb and ignites the charge which ejects the parachute and flare.*

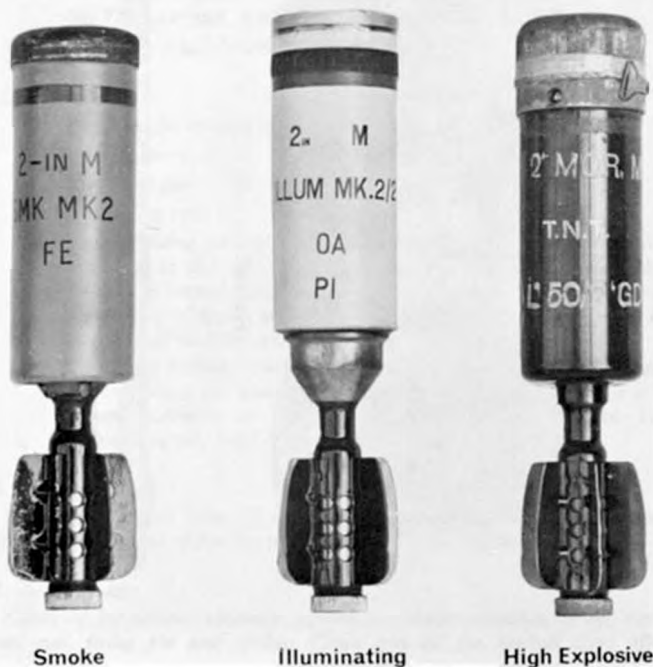

Fig 5.—Smoke, illuminating and HE bombs

28. Drill bombs have a black body, white metal unpainted tail and are marked with the word "DRILL" in white on the body.

29. Practice inert (sand filled) bombs have a black body, white metal unpainted tail, with the type and mark of bomb painted in white. In addition they have a red filling ring near the head (when a cartridge is fitted) and yellow band denoting practice. These bombs are filled with either sand or HE substitute. These fillings are denoted with the words "SAND WEIGHTED" or "HE SUB" respectively in white immediately below the yellow band.

These bombs can be used for firing practice. When fitted with a cartridge, ie, with a red filling ring, they must be treated as live smoke and fired under the same precautions as laid down for the firing of smoke bombs (see Chapter 3, Section 2). **THEY MUST NOT BE USED FOR DRILL PURPOSES** because they can be fired like live smoke and HE bombs, but do not explode or emit smoke at the target end.

30. Bombs are packed in brown metallised boxes, stencilled to show the type they contain: each box holds three brown carriers, which are marked in yellow with the type of bomb they contain.

Bombs may also be packed in brown wooden boxes, stencilled to show the type they contain. Each box holds twenty bombs in individual sealed brown metal containers that are marked in yellow with the types of bomb they contain.

31. Question the men on identification of bombs and carriers.

Conclusion

32. (a) Questions from and to the men.
(b) Sum up.

LESSON 2.—LOADING, UNLOADING AND FIRING

Aim

33. To teach loading, unloading and firing.

Stores

34. Mortars, utility pouches, holdalls, drill bombs.

Notes

35. (a) Drill bombs can be used to practise the actions of loading and unloading. Live smoke and illuminating bombs can be shown prior to the demonstrations in Lesson 3 they must not be used for drill purposes.

(b) During elementary training, the mortar must always be laid with reference to an aiming mark.

(c) Suggested words of command for training are:—

"Lying (kneeling) position mount mortar",
"Smoke (etc) Load", "300 (etc)", "High (Low) angle", "Fire",
"Unload" and "Dismount mortar",
given at appropriate times during the lesson.

(d) If teaching HE bombs see Chapter 2.

Preliminaries

36. (a) Normal safety precautions (see Lesson 1).
 (b) Revise cleaning before firing.

Approach

37. *Smoke and light, when required must be produced quickly and accurately. All actions such as loading, laying and action on misfire must be practised until they become automatic.*

Safety Precautions

- 37A. (a) **Before loading the first bomb the No. 1 must ensure that there is no obstruction in the barrel.**
 (b) **The mortar is NOT to be loaded in anticipation of delayed firing; however, if the team has been allotted a task which necessitates a delay between loading and firing, under NO circumstances is the weapon to be left unattended.**

Loading and unloading

38. Explain and demonstrate paras 39 to 41.
39. *When bombs of any type are issued, check them for correctness of type and check the caps on the tail units to ensure that they are screwed up tightly. A loose cap may cause a misfire.*
40. *To load with either type of bomb (see Fig 6):—*
- (a) *Adopt either the lying or kneeling position. If lying, lie straight behind the mortar, keeping the spade base well clear of your chest. Hold the mortar with your left hand at the hand grip, the right hand holding the firing lanyard. If kneeling, kneel on your right knee, keeping it well out to the right, clear of the spade base. In both cases, position yourself centrally behind the mortar so that you are looking straight over the white line. This will assist in more accurate laying.*
- (b) *Take off the muzzle cover, ensure that the barrel is at an angle of about 800 mils (45 degrees). Place the bomb in the barrel, tail first, give the bomb a gentle push downwards to ensure that it seats firmly on the steel pad; at the same time, let your hand slide down the outside of the barrel: this will ensure that your hand is not over the muzzle when the bomb reaches the steel pad. Great care must be taken by the No. 1 to ensure that only ONE bomb is loaded into the mortar. Failure to comply with this simple rule will result in a serious accident. Should a No. 2 be loading, he will NOT load except on orders from No. 1.*
- (c) *Grip the firing lanyard with your right hand.*
- (d) *If a No. 2 is present he is to lie or kneel on the right side of No. 1 and load. He is then to pick up another bomb ready for loading.*



Fig 6.—Loading

41. To unload (see Fig 7)—Tip out the bomb into your hand, or into No. 2's hand. Put on the muzzle cover.



Fig 7.—Unloading

42. Practise the men in loading and unloading.

Laying

43. Explain and demonstrate paras 43 and 44:—.

- (a) *Smoke bombs can be fired at either a high or a low angle (see Fig 8). Low angle is between 800 mils (45 degrees) and the horizontal; high angle is between 800 mils (45 degrees) and the vertical. Angles are taken from level ground; this must be considered when the mortar is positioned on sloping ground. With high angle firing the bomb goes high in the air and descends almost vertically; with low angle the bomb's trajectory is much flatter.*



The mortar is being fired at an angle of 1067 mils (60°)=475m

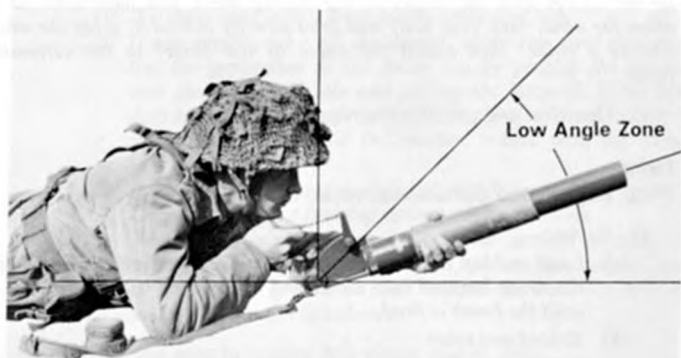

The mortar is being fired at an angle of 356 mils (20°)=375m

Fig 8.—High and low angle

- (b) *Use high angle when the target area is behind buildings or a hill or under other conditions when the bomb is required to drop steeply or when low angle would not give crest clearance.*
- (c) *Use low angle whenever you can, because the bomb is less affected by wind.*
- (d) *The maximum angle (which for safety reasons is not to be exceeded in peace time) for firing illuminating bombs is 1422 mils (80 degrees). In general, the most effective angle for firing illuminating bombs is 800 mils (45 degrees). At this angle good illumination of any target can be achieved without illuminating the firer to the enemy.*
- (e) *You adjust the range by raising or lowering the barrel. An angle of 800 mils (45 degrees) will send the bomb about 525 yards (481 metres). You decrease the range when firing high angle by raising the barrel, and by lowering the barrel when firing low angle. The minimum practical range is about 200 metres, with an angle of about 1333 mils (75 degrees) high angle or 142 mils (8 degrees) low angle.*
- (f) *Side wind affects the bomb by blowing it off its course. To overcome this effect the mortar must be laid off the target into the wind. For head winds more range is required; for rear winds less. The exact angle and line required for any particular target can only be found by observing the fall of the bomb and correcting accordingly.*

44. *To lay the mortar for line and elevation you hold the mortar firmly in the left hand with your fingers as far round the barrel as possible, line up the barrel with the target or the aiming mark you have selected to allow for wind, keep your body and head directly behind it, using the white line as a guide: then adjust the angle of the barrel to the estimated range.*

45. Question and practise the men in laying.

Firing

46. Explain and demonstrate paras 47 and 48.

47. *To fire:—*

- (a) *Load and lay the mortar as taught. Keep perfectly still and pull the firing lanyard backwards and downwards without jerking it, until the bomb is fired.*
- (b) *Reload and relay.*
- (c) *Watch the fall of the bomb and make any necessary correction before firing again.*
- (d) *If the base plate "beds in" so much that you cannot pull the firing lanyard, resite and relay the mortar before firing the next bomb.*

Corrections

48. Your No. 2 is to give corrections as follows:—

Bombs short of target:	“Add hundred”
Bombs beyond target:	“Drop hundred”
Direction:	“Go right—or left”, or “Go slightly right or left”
Bombs hitting target or area:	“Range”.

Bold corrections only are to be made or given, because pinpoint accuracy is not required with smoke bombs.

49. Practise the men in firing both singly and in pairs.

Misfire drill

50. Explain and demonstrate paras 51 to 53.

51. *Misfires are rare and normally, will not happen if the mortar is prepared and fired correctly.*

52. *Misfires are caused by:—*

- A damaged or broken firing pin.*
- Fouling on the steel pad or in the firing pin hole.*
- Bomb tail cap not screwed up.*
- Bomb not resting on the steel pad.*
- Faulty cartridge or a breakage in the mortar firing mechanism.*

53. *Should a misfire occur:—*

- Raise the barrel to the vertical, shake it, relay and fire.*
- If it still misfires, unload and examine the cartridge cap:—*
 - If struck, load with a fresh bomb, relay and fire.*
 - If not struck, take off the barrel, clean the steel pad and test the protrusion of the firing pin by placing the thumb over the firing pin hole and pulling the lanyard. If the pin does not protrude change it, ensure that there is no obstruction in the barrel, assemble the mortar, reload with the same bomb, relay and fire.*
- Do not use bombs the caps of which have been struck. During peace-time training destroy them as blinds.*
- If a misfire occurs at night, carry out the actions detailed in sub-para (a) above. If the mortar still fails to fire, unload and load a fresh bomb. If it again fails to fire, carry out the actions detailed in sub-para (b) (ii) above.*

54. Practise the men in misfire drill singly and in pairs.

Conclusion

- Questions from and to the men.
- Sum up.

PRACTICE—LESSONS 1 AND 2**Aim**

56. To practise stripping, care and cleaning, assembling, loading, laying, firing, unloading and action on misfire to prepare the men for live firing.

Stores

57. Mortars, holdalls, utility pouches, drill bombs.

Notes

58. See Chapter 2, Section 1.

Preliminaries

59. Normal safety precautions (*see* Lesson 1).

Approach

60. Remind the men of the need for careful cleaning and servicing of the mortar and the need for quick and accurate handling.

Suggested methods of practice

61. (a) *Stripping and assembling.* Practise the men in stripping and assembling and cleaning before firing, identification of bombs and spare parts by day and simulated night conditions.
- (b) *Loading and unloading.* Practise the men in loading and unloading individually and in pairs.
- (c) *Laying, firing, action on misfire.* Practise the men in laying, firing and action on misfire, singly and in pairs from different positions.

Competitions

62. Divide the men into two groups—masters and pupils. Organize individual and team competitions based on Training Tests Nos. 1 and 2.

Conclusion

63. (a) Questions from and to the men.
- (b) Sum up progress made

LESSON 3—THE EMPLOYMENT OF SMOKE AND ILLUMINATING BOMBS

Aim

64. To teach the employment of smoke and illuminating bombs.

Stores

65. Mortars, cleaning kit in holdalls, utility pouches, bomb carriers, smoke and illuminating bombs, large diagrams of smoke screens, blackboard.

Notes

66. (a) This lesson consists of a lecture, which should be followed immediately by a demonstration in the use of smoke and illuminating bombs, followed by practice.
- (b) Have diagrams, prepared blackboards, etc, ready to hand.
- (c) For safety rules regarding the use of smoke bombs *see* Chapter 3, Section 2.
- (d) After the initial practice further practice will take place during section and platoon tactical exercises.
- (e) Practice in the use of illuminating bombs must take place at night.

Preliminaries

67. Normal safety precautions (*see* Lesson 1.)

SUBJECT MATTER OF LECTURE

General

68. The light mortar (2-inch) is the platoon commander's smoke and light producing weapon. It is normally manned by a team consisting of two men. It is difficult to conceal because it emits a puff of smoke, especially in damp conditions, with every bomb fired. Whenever possible it should be fired from a concealed position, giving bullet-proof cover to the firer and concealing the smoke from the barrel. Care must be taken when firing from inside woods, etc, that there is no obstruction to the bomb's flight. Sometimes, however, speed in producing smoke is more important than caution: in these circumstances the mortar can be fired quickly from any position in the open. Pinpoint accuracy is not required but the bomb must be placed in the area selected or indicated.

The mortar team

69. The team consists of a No. 1 and No. 2 mortarman. Between them normally they carry the mortar, holdall and 18 bombs. The team forms part of the platoon HQ and is under the direct command of the platoon commander. It is important that all platoon HQ personnel should know how to fire, handle and maintain the mortar in action, how to select points of burst for smoke bombs, how to lay an effective smoke screen, and how to use illuminating bombs.

69A. The platoon commander is to decide, according to the tactical requirement, the proportion of smoke and illuminating bombs which will be carried. In some situations it may be necessary for additional bombs to be carried by the team or within the platoon.

Use of smoke

70. Smoke is used to screen movement of our own troops from aimed fire or observation, or to distract the enemy's attention. For all practical purposes smoke will only be used in the attack, since it favours the attacker but hampers the defence.

71. Smoke can be used for:—

- (a) Concealing the movements of sections from an exposed position to a better one.
- (b) Making an artificial defilade to screen the advance when no natural cover exists.
- (c) Thickening up, or filling gaps in an existing smoke scree
- (d) Distracting the enemy's attention by laying a screen in a different position from the actual axis of attack.

72. Smoke has certain limitations:—

- (a) Its full effect depends on suitable weather, because:—
 - (i) It is virtually impossible to lay an effective screen in a high wind.
 - (ii) Winds blowing at right angles to the screen affect its duration.
 - (iii) With no wind a larger number of bombs is required.
- (b) Owing to their weight the number of smoke bombs carried is comparatively small.
- (c) It may make aimed supporting fire impossible.

73. The screen should be laid as close as possible to, or even on, the enemy position. If this is not done, it is possible that troops on emerging from a screen will be silhouetted against the smoke, thus presenting good targets to the enemy.

74. Smoke tends to conform to the ground and will rise over hedges and woods.

75. Each bomb produces a cloud of low lying smoke lasting about two minutes. The effectiveness of this cloud from a screening point of view will depend upon the wind's strength and the firer's skill in selecting the points of burst.

76. Smoke screens are usually laid only on the orders of the platoon commander. Normally only brief orders will be given by the platoon commander to No. 1 mortarman, such as, "Smoke that wood—now". This means that every one of the mortar team must watch the battle and be able to understand the platoon commander's intention, and be able quickly and accurately to lay an effective screen.

77. When time is available the platoon commander may be in a position to give fuller orders. He should, in these circumstances, include the following:—

- (a) The position of our own troops and details of their intended movement.
- (b) The location of the enemy position to be screened.
- (c) The number of bombs allotted to the task.
- (d) The time at which the screen must become effective, and the length of time it must last.

Consideration and effect of wind

78. The fire controller, or the firer if acting alone, must always consider the wind's strength and direction, to get the best results with as few bombs as possible.

79. **Cross winds** (*see* Fig 9). The bombs should fall up wind of the target and slightly in front of it. The distance up wind will depend upon the wind's strength. As soon as the firer has found his correct point of burst he should fire another bomb immediately to obtain the necessary density. Thereafter he must feed the screen by observation, taking into account:—

- (a) The time it takes the bomb to travel to its point of burst and to emit smoke in volume.
- (b) Any change in the wind's strength and direction, which may require the selection of a new point of burst.

80. **Following and head winds** (*see* Fig 10). When it is necessary to lay a screen in a following wind, at least two points of burst and therefore more bombs will be required. The distances given are a guide only; they will vary according to the wind's strength and direction.

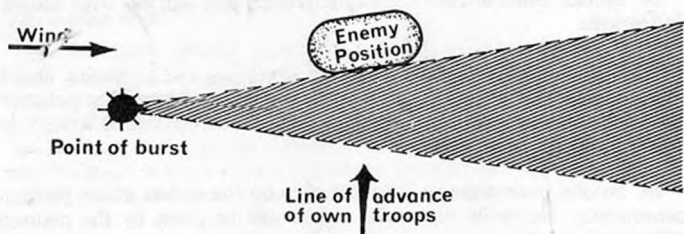

Fig 9.—Use of smoke in a cross wind

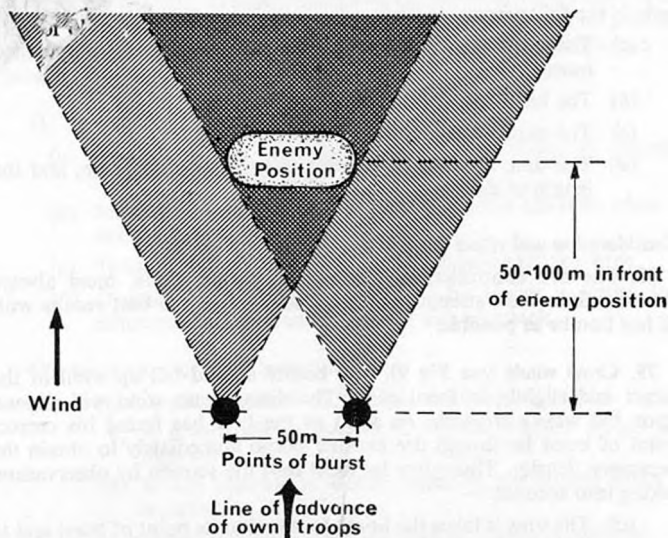

Fig 10.—Use of smoke in a following wind

81. If the movement to be screened is to a flank of the enemy position, the point of burst must always be up wind and to the required flank (see Fig 11). This applies to both following and head winds, and is the only instance in which it is worth while to use smoke in a head wind.

82. The method of initiating and feeding the screen is the same as for a cross wind.

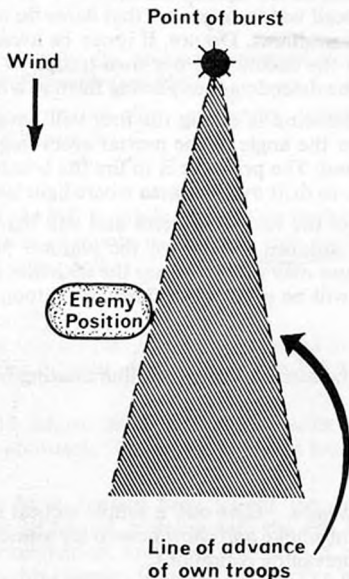

Fig 11.—Use of smoke for flank screening

83. Question the men and give them simple problems on the effect of wind.

Illuminating bombs

84. (a) These bombs contain a flare attached to a parachute. When the bomb is fired at an angle of 800 mils (45 degrees), the flare bursts at a height that will give the best overall performance. It burns for about 30 seconds, descending slowly and drifting with the wind as it does so.

(b) When fired at an angle of 800 mils (45 degrees), the flare bursts about 280 metres from the firing position and illuminates an area about 200 metres in radius, centred on a point immediately below the flare. This gives the best target illumination under most circumstances, with the minimum illumination of the firing position.

- (c) Whenever possible place the flare behind the enemy, as this will silhouette him against the light. To avoid our own troops being silhouetted against the light care must be taken, especially in head winds, to ensure that flares do not drift behind our forward positions. Do not, if it can be avoided, place the flare between the enemy and our own troops as its effect will be to dazzle the defenders thus placing them at a disadvantage.
- (d) When the wind is strong the firer will have to judge its effect and alter the angle of the mortar according to where the light is required. The principle is to fire the bomb up wind, allowing the flare to drift over the area where light is required.
- (e) Although the flare is efficient and will light up the battlefield a good distance in front of the platoon position, its uncontrolled use may also show up the activities of our own troops. Orders will be given when flares at platoon level are *not* to be fired.

85. Question the men on the use of illuminating bombs.

Demonstrations

- 86. (a) *Smoke bombs.* Give out a simple tactical setting necessitating the use of smoke and show how to lay a smoke screen according to the prevailing conditions.
- (b) *Illuminating bombs.* Show the effect of firing these bombs at different angles. The effect of the light can only be shown at night.

Practice

- 87. (a) *Smoke bombs.* Using different types of ground and tactical situations practise the men in laying smoke screens, giving short and full orders (*see* Chapter 3, Section 2).
- (b) *Illuminating bombs.* Carry out practice firing at night against pull up targets using the bomb for illumination. The proof of the correct use of the bomb will be the rifleman's ability to see and hit the target.

Conclusion

- 88. (a) Questions from and to the men.
- (b) Sum up.

CHAPTER 2

THE HIGH EXPLOSIVE (HE) BOMB

Aim

89. This chapter contains the necessary material to teach the use of the high explosive (HE) bomb (*see* Fig 12).

90. Additional information for instructors together with range safety is covered in Chapter 3.

Tactical employment

91. As the use of the HE bomb is retained by certain theatres for IS duties only, the amount of bombs carried and their tactical employment is left to the theatre commanders.

Training

92. The matter in this chapter should be included in the appropriate lessons by instructors in units dealing with the HE bomb (*see* paras 95 to 101).

Instructors should adjust the aim of the lessons where necessary together with their approach. The stores will also have to be adjusted for certain lessons.

93. When troops have already been taught the drills and use of smoke and illuminating bombs, training with the HE bomb should be in the form of an explanation, and demonstration if necessary, of the additional matter in this chapter, followed by practice with drill bombs.

94. Every effort should be made to introduce live firing practice as soon as possible.

Lesson 1

95. *The light mortar can also be used to fire a high explosive (HE) bomb which has the same range as the smoke bomb. The bomb weighs about 2½ lb. It bursts immediately on impact, and so has little power of penetration. It is most effective against men in the open, behind high cover and against "soft skinned" vehicles. Owing to the fact that casualties may be inflicted by bomb fragments up to 150 metres from the point of burst, the mortar when used with HE is, as it is with the smoke bomb, an area weapon. Although every effort must be made to place the bomb as near to the target as possible, you must not expect to hit a pin-point target every time, otherwise bombs and time will be wasted by chasing imaginary errors when in actual fact your fire may have been effective.*

Note: For details of the fragmentation danger area of the light mortar HE bomb, *see* Infantry Training, Volume III—Ranges and Courses, Pamphlet No. 32—Range Construction and Regulations (All Arms), 1958 (Army Code No. 9486), para 282A (as promulgated by Amendments No. 5).

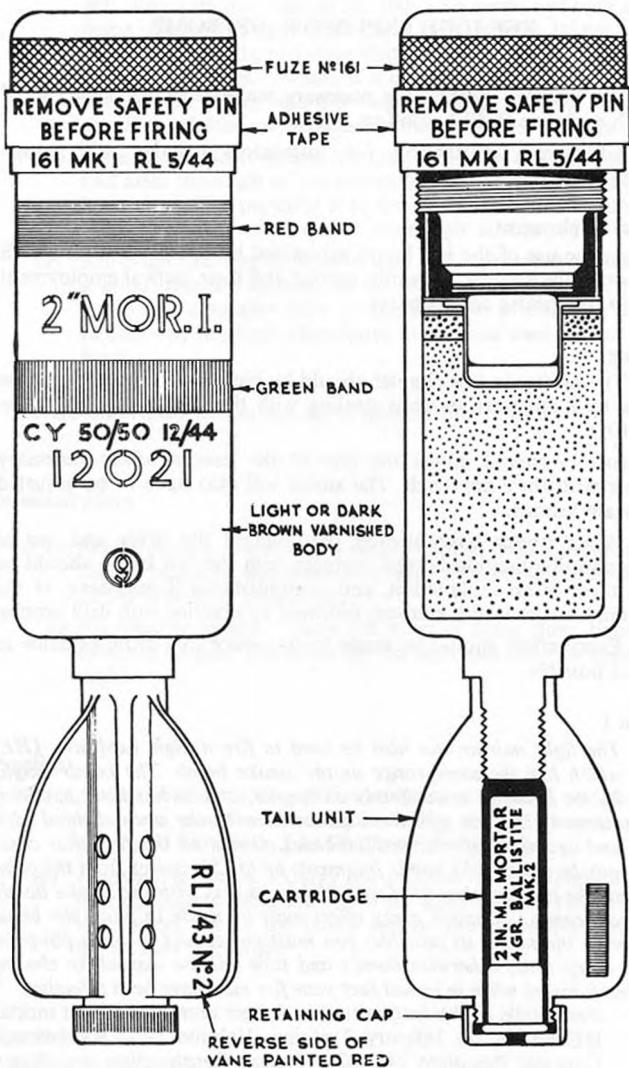

Fig 12.—The HE bomb

96. The HE bomb has a buff painted body, with red and green bands round it and a white metal unpainted tail. The head of the bomb is covered by a screw-on safety cap, underneath being a safety pin. The name, mark, lot number and date of manufacture are painted, in black, on the body. There is a cartridge in the tail which when fired propels the bomb.

97. The carriage of HE bombs is the same as for smoke and illuminating. The carriers are marked with the type of bomb in yellow.

Lesson 2

98. Besides ensuring that the tail unit caps are screwed up, you prepare the HE bomb for firing by removing the adhesive tape and safety cap. Do not remove the safety pin at this stage. The number of bombs prepared will depend upon the task in hand.

99. Once the tape and cap have been removed, damp may affect the fuze: bombs should therefore only be prepared just before they are fired. Any bombs which are not used must have the cap and tape replaced before being put back into their containers. If, in spite of these precautions, the fuze and cap have been affected by damp, they must be dried before the cap is replaced.

100. You remove the safety pin immediately before loading the bomb into the mortar.

101. Once the safety pin has been removed from a bomb, it must be either fired or destroyed as a blind before leaving the position.

CHAPTER 3

ADDITIONAL INFORMATION FOR INSTRUCTORS

GENERAL

102. This chapter contains:—

- (a) Extra information to enable instructors to understand the subject more thoroughly and make training more varied. Do not teach it to recruits. It is useful when answering questions on things that the lessons do not cover and is suitable material to teach on an NCOs' cadre.
- (b) The procedure to be adopted on mortar ranges and the safety rules which must be enforced.

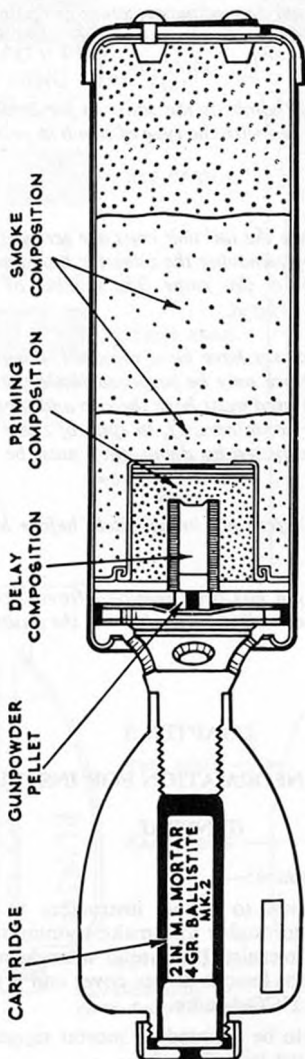

Fig 13.—The smoke bomb (mechanism)

SECTION 1—CHARACTERISTICS AND TECHNICAL DETAIL

Mechanism of smoke bombs

103. On firing, the flash from the cartridge penetrates the closing discs and ignites a small charge of gunpowder, which in turn sets off the delay pellet. This ignites the priming composition and thus the smoke composition. The mechanism for ignition is at the base of the bomb, and the cartridge, in addition to its function as the propellant, starts off the ignition. The delay pellet prevents the emission of smoke for about five seconds (*see* Fig 13).

Mechanism of illuminating bombs

104. The flash from the cartridge, when fired, penetrates the closing discs and ignites a delay charge; this in turn ignites a bursting charge of gunpowder which ignites and ejects the flare; a small parachute, packed in the nose of the bomb, is attached to the flare and is ejected at the same time, opening at once and suspending the flare below it (*see* Fig 14).

Mechanism of HE bomb (*see* Fig 15)

105. The fuze is in the head of the bomb and is covered by the safety cap and is fitted with a safety pin. Both the cap and pin must be removed before firing.

106. **Action of fuze on firing.**—On firing, the shock of discharge causes the detent to set back and compress its spring. This opens the diagonal channel. The striker also sets back slightly on the shock of discharge and frees the ball, which travels outwards and downwards over the detent into the recess. This allows the striker, actuated by its spring, to withdraw until its base meets the brass cap. As the striker withdraws, the shutter, into which is fitted the detonator, pivots under the influence of its spring, until the detonator in it is immediately below the point of the striker, and over the exploding composition in the disc above the magazine; the bomb is now fully armed.

107. **Action on impact.**—When the bomb strikes an object, the cap is crushed in and forces the point of the striker on to a detonator. The detonator ignites the exploding compound which in turn detonates the high explosive in the magazine.

The safety pin (*see* Fig 15)

108. The safety pin is to prevent the possibility of the bomb becoming armed through receiving a hard blow such as it might sustain when supplies are dropped from aircraft. The pin secures the ball on its seating so that, should the detent momentarily set back, the ball is kept in position, engaging the striker.

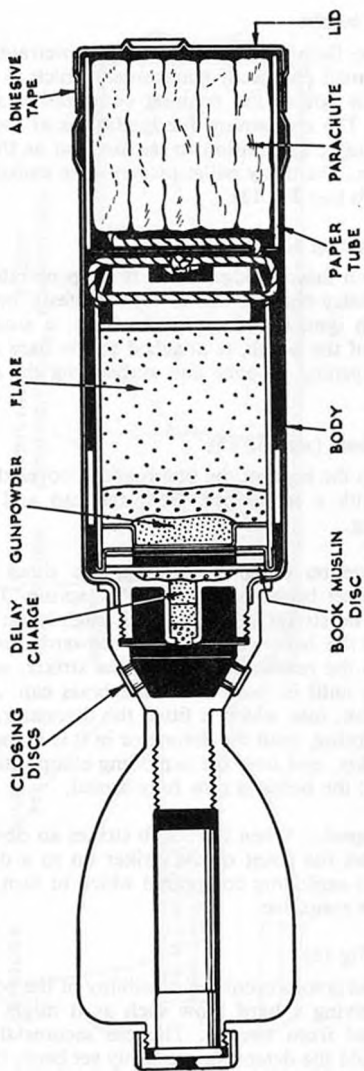

Fig 14.—The illuminating bomb (mechanism)

FUZE, PERCUSSION, DA NO. 161, MK 1.

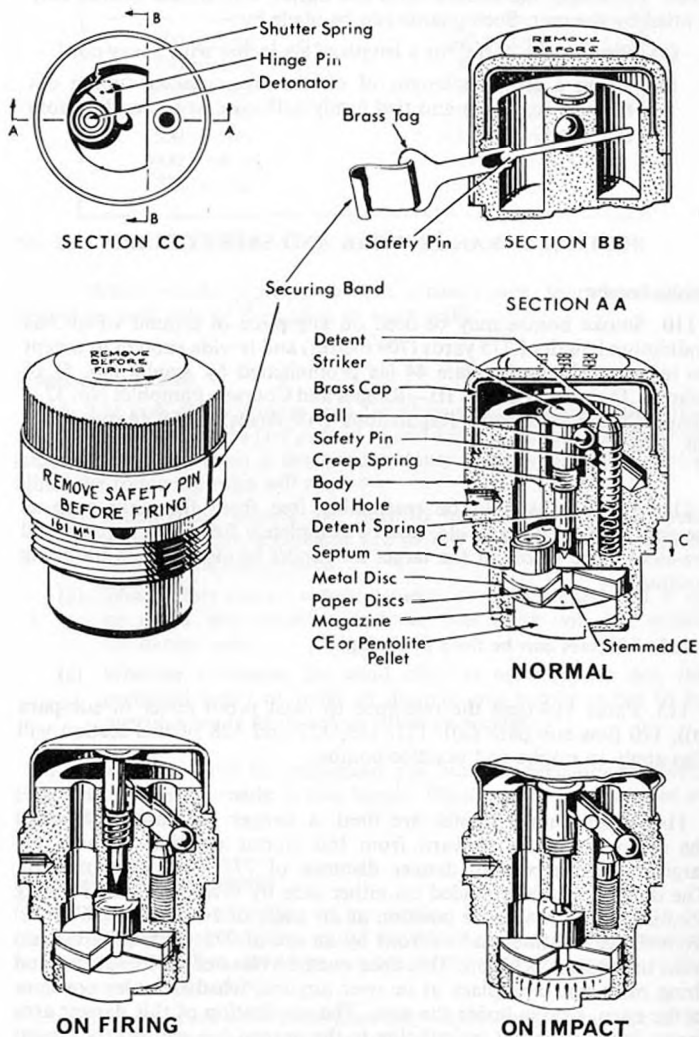

Fig 15.—The mechanism of the No. 161 Fuze

Protection from hot barrels

109. To protect the hand from a hot barrel, improvised guards may be fitted by the unit. Such guards can be made by:—

- (a) Binding the barrel for a length of six inches with heavy cord.
- (b) Using a six inch length of old bomb container tubing cut through its length and tied firmly with cord at top and bottom (see Fig 6).

SECTION 2—RANGE WORK AND SAFETY RULES

Smoke bombs

110. Smoke bombs may be fired on any piece of ground which has a minimum length of 775 yards (709 metres) and is wide enough to accept the template shown in Plate 44 (as promulgated by Amdts No. 5) of Infantry Training, Volume III—Ranges and Courses, Pamphlet No. 32—Range Construction and Regulations (All Arms), 1958 (Army Code No. 9486).

111. The area should be reasonably free from fire risks such as hayricks, long dry grass, etc, and be completely free from persons and live-stock. The whole of the target area must be visible from the firing position.

112. Mortars can be fired in the open.

113. Paras 119 (less the reference to blast proof cover in sub-para (a)), 120 (less sub-para (a)), 121, 126, 127 and 128 of this section will also apply to smoke and practice bombs.

114. When smoke bombs are fired, a danger area exists of which the centre line runs forward from the mortar position through the target to the maximum danger distance of 775 yards (709 metres). The danger area is bounded on either side by divergent lines running forward from the mortar position at an angle of 15 degrees (267 mils) from the centre line, and in front by an arc of 775 yards (709 metres) from the mortar position. This area must be clear of all live-stock, and firing must not take place at or over anyone, whether under cover or in the open, who is inside the area. The application of this danger area means in practice that (calculating to the nearest five metres) the closest that any troops can be allowed to approach the line from mortar to target at each range is shown below:—

Distance forward	Minimum distance between troops and line mortar – target
100 metres	30 metres
200 metres	55 metres
300 metres	80 metres
400 metres	110 metres
500 metres	135 metres
600 metres	165 metres
700 metres	190 metres

See also paras 130 to 132.

115. Where smoke is likely to drift across roads, sentries must be posted on each side of the screen to warn traffic.

Illuminating bombs

116. The size of the danger area for illuminating bombs is the same as that for smoke bombs (*see* paras 114 and 130). In peace time, to avoid accidents resulting from a descending empty canister of a free falling blind, the following rules will apply:—

- (a) Illuminating bombs are only to be fired on training areas which offer an acceptable arc of fire and are large enough to contain this danger area.
- (b) Wind effect on an empty canister or a possible blind is to be taken into consideration, so that these will fall within the danger area.
- (c) Whether allowance for wind effect is necessary or not, the predicted point of burst of illuminating bombs is not to be over the heads of troops or other personnel.

117. Fire risks must be considered and suitable precautions taken. Every effort must be made to find blinds. Blinds are to be destroyed as for smoke bombs.

Practice (sand-filled) bombs

118. The same precautions as for smoke, less fire risks, are to be observed. Special precautions must be taken to ensure that practice bombs fitted with live cartridges are not mixed with or returned to the same store as drill bombs.

Practice bombs are to be fired once only. Recovered bombs are to be disposed of in accordance with Regulations for Army Ordnance Services, Volume 4—Ammunition, Pamphlet No. 26, Section 8.

HE bombs

119. The firing of HE bombs must be supervised by a qualified or authorized officer or warrant officer (*see* Infantry Training, Volume III, Pamphlet No. 31—Range Conduct and Safety Rules (All Arms), 1969 (Army Code No. 70495), Section 10), and the following rules must be complied with:

- (a) Everyone in the danger area, including waiting details and spectators, are to be behind blast proof cover or in a trench and are to wear steel helmets.
- (b) A medical orderly, with first-aid appliances, and an ambulance, is always to be in attendance when live ammunition is being used. If an ambulance cannot be made available then a suitable vehicle in lieu must be provided.
- (c) All danger flags must be raised, lookout men posted, and the whole of the ground included in the danger area must be clear of persons and live-stock.
- (d) No mortar is to be loaded or fired without a direct order from the officer in charge.
- (e) Demolition equipment for the destruction of blinds is always to be taken to the range.
- (f) Ear protectors or cotton wool should be used during all mortar firing.
- (g) Local range orders, rules and regulations must be observed.

120. An NCO is to be detailed to supervise each mortar. Junior NCOs may be used for this task provided that they have been trained and rehearsed in their duties by a qualified officer, warrant officer or senior NCO. The NCO in charge of each mortar is to be responsible:—

- (a) That the safety cap and safety pin is removed from each bomb before loading.
- (b) That each bomb is loaded tail first into the mortar.
- (c) That both crest and local clearance is assured.
- (d) For following the flight of each bomb, so that, if it is a blind, he can note its position and report it to the officer in charge.

121. Targets less than 200 metres away from the mortar positions have *not* to be engaged.

122. When HE is to be used in peace time, the mortar is to be fired from the kneeling position, and the weapon and firers must be protected by substantial splinter-proof cover not less than 30 inches high between the mortar position and the target. Great care must be taken to ensure that there is adequate muzzle clearance each time the mortar is fired, but, subject to this, the cover should if possible be reasonably close in front

of the mortar position. Immediately the fall of the bomb has been observed, all firers and supervisors must have their heads down below the level of the cover. Mortar positions are to be at least 20 metres (22 yards) apart.

123. Only the officer in charge, instructors, firers and, if necessary, loaders are to be on the firing point. Waiting details and spectators at demonstrations are to be outside the danger area or under cover in rear of the firing line.

124. Only the amount of bombs necessary to fire one detail are to be on the firing point. All other bombs must be on a ready line outside the danger area, ie, at least 100 metres behind the mortar or under cover a suitable distance to the rear.

125. Bombs are not to be prepared for firing until brought to the mortar position.

126. Firing must stop when any aircraft flying at any height enter the firing area.

127. The target area must always be visible from the firing point or control tower.

128. When practising in peace time or when giving demonstrations, the mortar is not to be fired at a greater angle than 1333 mils (75 degrees) from the horizontal. Bombs fired at this angle will fall approximately 200 metres (219 yards) away. Care must be taken to ensure that the ground beneath the mortar provides a firm base and that adequate allowance is made for head winds.

Field firing exercises

129. HE bombs are not to be used on field firing exercises. This is because the mortar is a hand-held weapon and its accuracy is accordingly dependent entirely on the skill of the firer.

Danger areas – light mortar

130. Templates of danger areas for all types of light mortar bomb are shown in Plate 44 (as promulgated by Amdts No. 5) of Infantry Training, Volume III—Ranges and Courses, Pamphlet No. 32—Range Construction and Regulations (All Arms), 1958 (Army Code No. 9486).

131. A single line of fire offers little scope; the ideal is a range with an arc of fire of no more than 1067 mils (60 degrees).

132. The size of the arc usually depends on the ground available;

correct application of the danger area template ensures that the best possible use is made of the ground.

133. Danger heights for the light mortar are being promulgated in amendments to Appendix 2 to Infantry Training, Volume III—Ranges and Courses, Pamphlet No. 32—Range and Construction and Regulations (All Arms), 1958 (Army Code No. 9486).

Destruction of blinds

134. The method of destroying blinds is contained in Infantry Training Volume III, Pamphlet No. 31—Range Conduct and Safety Rules (All Arms), 1969 (Army Code No. 70495), Chapter 7.

SECTION 3.—PRACTICE PERIODS

135. All training must be progressive; unnecessary repetition is bad instruction. A soldier learns skills and facts in the basic lessons; he should be taught them once only during his service. He then needs a lot of time and practice to speed up his actions and to get the facts firmly fixed in his mind.

136. During the practice periods it may be obvious that the men have failed to grasp a particular skill or fact, and you may have to teach them part of a lesson again.

137. The practice periods suggested in this pamphlet are a guide to the best way of exercising soldiers during their basic instruction in the weapon, but watch their weak points and plan periods accordingly.

138. Spot and check faults immediately, otherwise soldiers will repeat their mistakes and delay progress.

139. The incentive of competition will always help to make practice more interesting. You can base the whole of a practice period on competitions or leave them until the end of the period. Some points in framing simple competitions are:—

- (a) Competitions may be for individuals or teams.
- (b) If you decide to have teams make sure they are fairly equal in performance. The more advanced member of a team will help along the weaker members.
- (c) Award marks up to a given total or start off with a total and deduct marks for mistakes.
- (d) Always have a small board or a piece of paper on which you can mark the results.

- (e) Obtain further interest by making one team or individual watch another to award or deduct marks.
- (f) Above all, make certain that your competitions are simple and realistic, ie, that they do exercise the men in the facts and skills involved.

SECTION 4.—METHODS OF PRACTICE IN LAYING SMOKE SCREENS

140. The best method of practising laying smoke screens is by the use of smoke bombs in a tactical setting. However, smoke bombs for training are limited in number, and smoke generators are an efficient substitute.

Method (using smoke generators)

- 141. (a) Rehearse suitable signals with an assistant to enable him to position and ignite the smoke generators.
 - (b) Select a piece of ground with features which will bring out the lessons you want to teach.
 - (c) Present a simple battle situation demanding the use of smoke.
 - (d) Call for solutions as to points of burst. Identify these points by means of a pointer staff.
 - (e) Select one solution, order the mortar team into action and when they fire, signal your assistant where to place the smoke generator and to light it.
 - (f) Discuss with the whole squad whether the screen was successful or not.
142. One generator will suffice for each problem.

SECTION 5.—TRAINING TESTS

Aim

143. To find out the standard of training men have reached.

Notes

144. Grade men as follows:—

Skilled	63 to 70 marks
Above Average	56 to 62 marks
Average	42 to 55 marks
Below Average	35 to 41 marks
Failure	Less than 35 marks

145. Recruits should achieve at least average at the end of their basic training: trained men who cannot do better than average need more practice. When a man is transferred, always tell his new unit his grading.

146. Let men practise the tests before doing them, and use the tests as competitions in practice periods.

147. Before testing a man, explain the test to him, and let him ask questions if he does not understand: once the test begins do not help him; always tell him the result of the test, and always explain any errors.

APPENDIX A
DETAILS OF TRAINING TESTS

No.	Subject	Stores	Detail	Standard
1	Care, cleaning and servicing	Mortar holdall Drill bombs Dress—clean fatigue	<p>(a) Order the soldier being tested to:—</p> <p>(i) Strip the weapon for cleaning.</p> <p>(ii) Assemble the weapon.</p> <p>(b) Question him on cleaning it before, during and after firing.</p> <p>(c) Question him on identification of spare parts and bombs.</p>	Give 20 marks, deduct 1 mark for each mistake HPS—20
2	Handling	Mortar holdall Drill bombs Dress—battle order	<p>Order the soldier being tested to:—</p> <p>(a) Prepare smoke or HE bombs for firing.</p> <p>(b) Load with smoke or HE.</p> <p>(c) Lay on a target (give a range and check angle).</p> <p>(d) Fire.</p> <p>(e) Deal with the following situations:—</p> <p>(i) Bomb will not fire.</p> <p>(ii) Still will not fire.</p> <p>(iii) Cartridge not struck.</p> <p>(iv) New firing pin required.</p>	Give 20 marks, deduct 1 mark for each mistake and up to 5 marks for bad handling HPS—20

No.	Subject	Stores	Detail	Standard
3	Tactical handling	Prepared black-board or diagram of enemy position or feature to be screened Chalk Mortar Dress—clean fatigue	<p>SMOKE BOMBS Ask the soldier being tested questions on selection of points of burst in the following conditions (get him to illustrate his answer on the blackboard or diagram):—</p> <p>(a) Cross wind. (b) Following wind. (c) Head wind. (d) His procedure after finding the correct point of burst.</p> <p>ILLUMINATING BOMBS Ask the soldier being tested the following questions:—</p> <p>(a) Show me the angle at which you normally hold the mortar to fire illuminating bombs? (b) Why is 800 mils the most effective angle for firing illuminating bombs?"</p>	Give up to 5 marks for each question. Deduct marks according to the accuracy of the answer.

CHAPTER 4

THE TRIPFLARE

Aim.

148. To teach the setting up and arming of a tripflare for use.

Timings.

149. One 20 minute period.

Method.

150. An outdoor instructional period.

Stores.

151. Instructional tripflares 1 per soldier
Combination tool/screwdriver 1 per soldier

Preparation.

152. (a) Select an area which allows each soldier 15–20 metres in length in which to set up his tripflare.
(b) Check that all instructional flares function and can be re-set.

Miscellaneous.

153. (a) Tripflares are to be handled carefully at all times whether packed in their containers or not, as rough handling may cause a flare to ignite, start a serious fire and severely burn anyone near it.
(b) When setting up a flare, do not position the head directly over the top of the flare pot.
(c) The safety pin on the flare pot is not to be removed until the trip wire has been secured in the clamp.
(d) To avoid injuries such as burnt hands, eyes and face, all armed tripflares which fail to ignite, when they should, are to be regarded as blinds. They are to be destroyed by the method laid down in Infantry Training Volume III, Pamphlet No 31, Range Conduct and Safety Rules (All Arms), 1969 (Army Code No 70495).
(e) Flares with missing safety pins, or loose or missing pivot screws are to be carefully removed and destroyed as for a blind and details reported to the local ATO.

Amdt 9/Nov/77

- (f) When tripflares are used on land to which the public cannot be legally denied access the flare, when positioned, is to be under surveillance at all times. Should a civilian approach the flare, he (or she) is to be warned of the danger. After the exercise has taken place, the officer in charge of the exercise will be held responsible for seeing that all uninited tripflares are set off or destroyed as blinds.
- (g) On land to which the public cannot be legally denied access tripflares are not to be used at night.
- (h) Instructional flares are to be re-set at the end of the lesson.

Preliminaries.154. **Safety Precautions.** Explain: Inspect each flare to ensure that:

- (a) The safety pin is in position and that the ends are splayed to prevent it accidentally falling out.
- (b) The pivot screw, which is towards the end of the actuating plate, is present.
- (c) Safety pins which are not splayed are to be splayed by carefully inserting a screwdriver blade between the two ends and twisting, at the same time holding the safety pin in position with the free hand.

155. **Revision.** Nil.**Approach.**

156. Explain: *The tripflare, when set off, produces a very bright light which illuminates the area around it for approximately a minute and a quarter. It is set off when the connected trip wire is fouled or cut. It is used therefore at night to give warning of approaching enemy and it is important that the soldier knows how to set it up and arm it.*

Equipment.

157. Explain:

- (a) *Tripflares are to be handled carefully at all times whether packed in their containers or not, as rough handling may cause a flare to ignite, start a serious fire and severely burn anyone near it.*
- (b) *The equipment consists of two sharpened metal pickets, a metal arm with a spring and wire clamp attached to it, a 20 metre length of wire on a spool and a pot containing the flare. Instructions for using the tripflare are packed with the equipment.*
- (c) *The flare pot is made of black plastic and the top is painted a dull olive colour. Around the top is painted a red filling band to*

RESTRICTED

41

warn that the flare contains an incendiary compound. An arm at the bottom of the flare pot holds a striker in position. The arm is prevented from moving by a safety pin.

- (d) Except for the pickets, all the equipment is packed in a plastic box contained in a brown tin.

158. Confirm by questions.

Setting up the flare (see Fig 16).

159. Explain and demonstrate:

- (a) Drive the pickets into the ground, one at each end of the area to be covered by the trip wire. The side prongs of the pickets are to face inwards and the bottom side prongs are driven into the ground.
- (b) Position the spring arm on the main post of the picket that is to hold the flare pot. Place it so that it extends away from the run of the trip wire and check that it has locked against the picket so that it can not turn when the trip wire is fastened to it. Loosen the clamp wing nut.
- (c) Remove the pin from the wire spool and place the ring at the end of the wire over the main post of the picket that is not holding the spring arm. To ensure that the ring does not slip off as the wire is being reeled out, make one or two turns of the wire over the side arm of the picket. Run out the wire until it reaches the spring arm and pass it around the clamp on the spring arm. Draw the wire tight until the spring is extended to the limit of the spring links and then secure the wire by tightening the clamp wing nut. Remove the spring link pin. If all the trip wire has not been used, replace the pin in the spool to prevent the wire unreeling itself further. Place the spool at the base of the spring arm picket.
- (d) Place the flare pot on the picket carrying the spring arm by sliding it on between the main post and the side arm. Unscrew the wing nut under the flare pot and, after making certain that the string on the flare safety pin is clear of the clamp, pass the wire into the jaws of the clamp and tighten the wing nut.

160. Confirm by practice.

Arming the flare (see Figs 17 and 18) and mechanism.

161. Explain and demonstrate: To arm the trip flare, keep the head away from and below the level of, the flare pot, remove the safety pin and retain it. When the wire is cut, walked into or pulled, the arm on the bottom of the pot is moved to one side and the striker is released thus setting off the flare.

162. Confirm by practice.

RESTRICTED

Conclusion.

163. End of lesson drill.

- (a) Questions from the squad on the entire lesson.
- (b) Confirm by questions.
- (c) Safety precautions.
- (d) Pack kit.
- (e) Summary. To include the following:
 - (1) The importance of handling carefully.
 - (2) A forecast of the squad's next lesson in this subject.

Amdt 7/Feb/75

CHAPTER 5

THE 1.5 INCH ROCKET FLARE

Aim.

164. To teach the characteristics, firing and safe handling of the rocket flare.

Timings.

165. One 10 minute period.

Method.

166. A basic instructional period best suited to a range day prior to live firing of rocket flares.

Stores.

167. Instructional 1.5 inch rocket flares—1 per soldier.

Preparation.

168. Recce the range or training area and select a location for the instruction.

Miscellaneous.

169. Live firing. The 1.5 inch rocket flare is to be fired only on ranges or training areas where:

- (a) The firing of light mortar (2 inch) illuminating bombs is permitted.
- (b) Live firing is to be conducted only by personnel qualified or authorized to conduct live firing with 2 inch mortar illuminating bombs as laid down in Infantry Training Volume III, Pamphlet No. 31, Range Conduct and Safety Rules (All Arms), 1969 (Army Code No. 70495).
- (c) Misfired or damaged flares are to be treated as blinds and destroyed immediately.
- (d) Flares which have had the tapes removed from the bottom cap are NOT to be retained for further use. They are to be fired or destroyed.
- (e) Soldiers should see a rocket flare fired at the earliest opportunity after instruction.

Preliminaries.

170. **Safety Precautions.** Check that both ends of the rocket flare are covered by tin plate caps sealed with adhesive tape.

171. **Revision.** Nil.

Approach.

172. Explain: *The rocket flare is a simple pyrotechnic designed to project parachute illuminating flares. When fired at an angle of 533 mils (30 degrees), it has a range of about 300 metres and bursts at a height of about 90 metres. The range and height can be varied by adjusting the angle of firing.*

Description and characteristics.

173. Explain:

- (a) *The rocket flare consists of a fibre-board launching tube, with a plastic plug at the base. This plug contains a simple folding trigger, a spring-loaded striker and an igniter. Both ends of the tube are covered by tin plate caps, which are sealed with adhesive tape. (See Fig 19).*
- (b) *Within the launching tube is the rocket cylinder, made of thin aluminium. This contains the rocket motor, the illuminating compound and the parachute.*
- (c) *The flare is a section illuminant.*
- (d) *The flare burns for approximately 30 seconds.*
- (e) *Total weight of the flare is 13 ozs. (368 gms).*
- (f) *Rate of fire is about three flares per minute.*
- (g) *Flares should be aimed to burst beyond the target, so that the target is silhouetted against the illuminated background.*
- (h) *Allowance must be made for the wind, as the parachute and flare will drift quickly with even a mild wind.*
- (j) *The weapon is recoilless.*

174. Confirm by questions.

Firing.

175. Explain and demonstrate:

- (a) *Hold the flare at the side of and away from the body at waist height. Care must be taken to ensure that both the nose and base end of the flare point in a safe direction.*
- (b) *First remove the sealing tape from the top cap (Do NOT remove the top cap, which is marked with an embossed "P") and then remove the sealing tape from the bottom cap.*

- (c) *Remove the tin cap from the base of the flare thus exposing the trigger. Remove the tape securing the trigger and unfold the trigger outwards.*
- (d) *Position the body so that the left shoulder is pointing towards the target area and grasp the tube firmly with both hands keeping it away from the body placing the little finger of the right hand on the trigger.*
- (e) *Decide on the allowance to be made for wind and the angle for firing. If a substantial allowance has to be made for wind it may be necessary to adjust the position of the body to enable the flare to be held firmly and comfortably with both hands.*
- (f) *Check that the body and limbs are clear of the area likely to be affected by flash and blast emitted from the bottom of the flare.*
- (g) *Squeeze the trigger gently.*

176. Confirm by practice.

Conclusion.

177. End of lesson drill:

- (a) Questions from the squad on the entire lesson.
- (b) Confirm by questions and practice.
- (c) Safety precautions.
- (d) Pack kit.
- (e) Summary. To include the following:
 - (1) The dangers of incorrect handling.
 - (2) A forecast of the squad's next lesson in this subject.

Amdt 7/Feb/1975

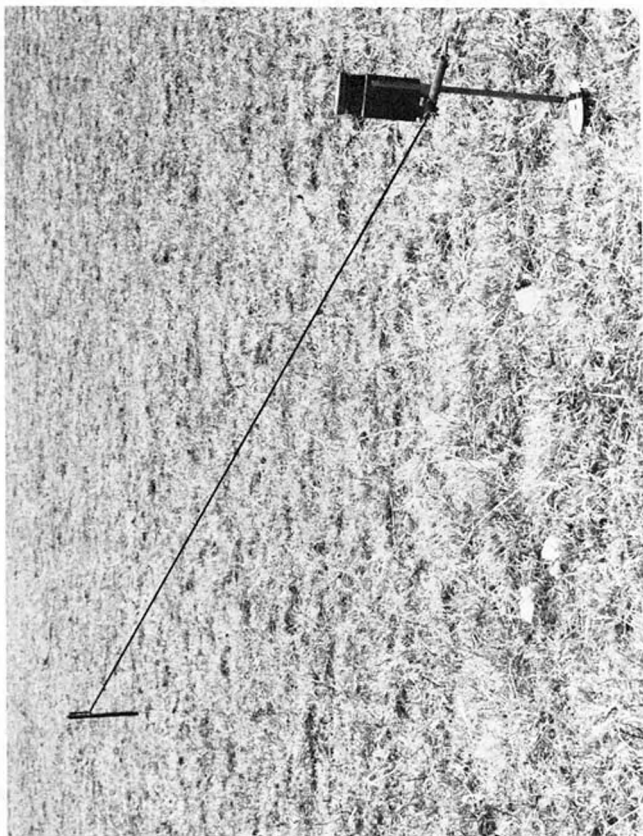

Fig 16.—A triplare set up

Amdt 7/Feb/75

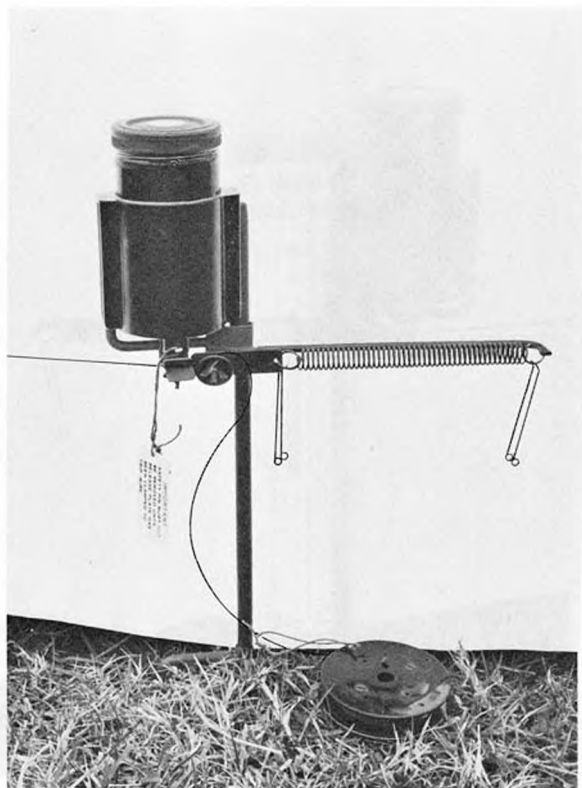

Fig 17.—The flare pot unarmed

Amdt 7/Feb/1975



Fig 18.—The flare pot armed

Amdt 7/Feb/75



Fig 19.—The 1.5 inch rocket flare

APPENDIX B

SIGNAL KIT PYROTECHNIC PISTOL 16 mm (MINIFLARE)

Aim

1. This appendix contains the information necessary to teach the soldier how to fire the 16 mm signal flare and the safety rules in its handling.

Description and Characteristics (See Fig 20)

2. Explain:

- (a) *The signalling kit consists of a pack containing eight flare cartridges and a straight tubular pistol complete with striker, spring and thumb stud. Cartridges have a percussion cap on their base. The pack has a removable plastic top. The complete kit weighs 0.266 kg (8 oz).*
- (b) *Currently each pack contains 3 white, 3 red and 2 green flares. The colour of the flare is painted on the top of the cartridge. Future packs may contain flares of all the same colour and have a night identification symbol embossed on the flare exterior.*
- (c) *A flare burns for approximately 5 seconds at a height of about 90 m (300 ft) and is visible and colour identifiable out to 1500 m.*

To fire a flare

3. Explain:

- (a) *Withdraw the pistol (see fig 21) from the pack then open the top of the pack.*
- (b) *Keeping the fingers clear of the thumb stud, insert the pistol into the pack and screw it into the selected colour cartridge.*
- (c) *Withdraw the pistol and cartridge and hold the pistol at arm's length pointing directly upwards.*
- (d) *With the thumb of the same hand, pull the thumb stud fully to the rear and release it. (This action causes the striker to hit the percussion cap at the base of the cartridge. The explosion ejects the flare which does not begin to burn for one or two seconds.)*
- (e) *Unscrew the empty cartridge case. These are to be returned to the ammunition compound.*
- (f) *Close the pack top and return the pistol to the pack.*
- (g) *When wearing NBC or arctic gloves, the thumb stud tends to catch in the glove material leading to minor delays in firing.*

Misfire Drill

4. Explain: Misfires are rare, however, if a cartridge fails to fire:

- (a) *Maintaining the firing position, pull the thumb stud fully to the rear and release it. The cartridge should fire.*

- (b) *If the cartridge still will not fire, maintain the firing position for 15 seconds then unscrew the cartridge and place it to one side. Misfired cartridges are to be returned to store to await ATO/AT disposal.*
- (c) *To minimize the possibility of a misfire caused by a weakened striker spring, one pistol is to be used to fire eight cartridges only.*

Safe Handling Rules

5. **Explain:** *Strict adherence to safety rules is essential in order to eliminate accidents involving both injury to personnel and damage to property. Therefore:*

- (a) *Cartridges are not to be removed from the pack other than by screwing onto the pistol and then only immediately prior to use.*
- (b) *A pistol with a cartridge screwed into position is to be pointed upwards at all times and away from the body or other personnel.*
- (c) *A pistol is not to be carried with a cartridge screwed into position.*
- (d) *The thumb stud is to be in its forward position whilst a cartridge is being fitted.*
- (e) *Keep the thumb clear of the thumb stud until the moment of firing.*
- (f) *Do not fiddle with the thumb stud on the pistol at any time.*

Amdt 8/Oct/77

53

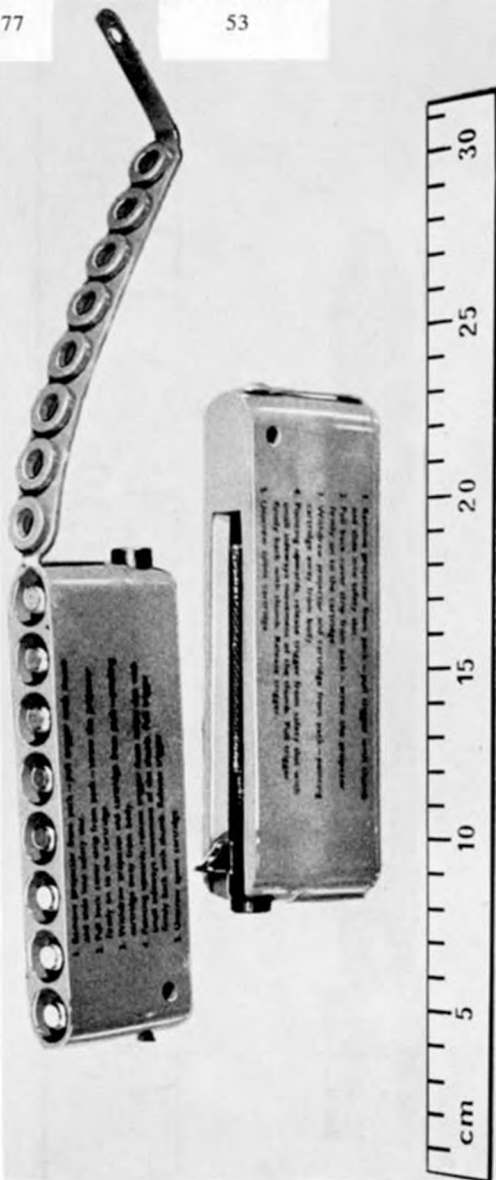

Fig 20. The signalling kit.

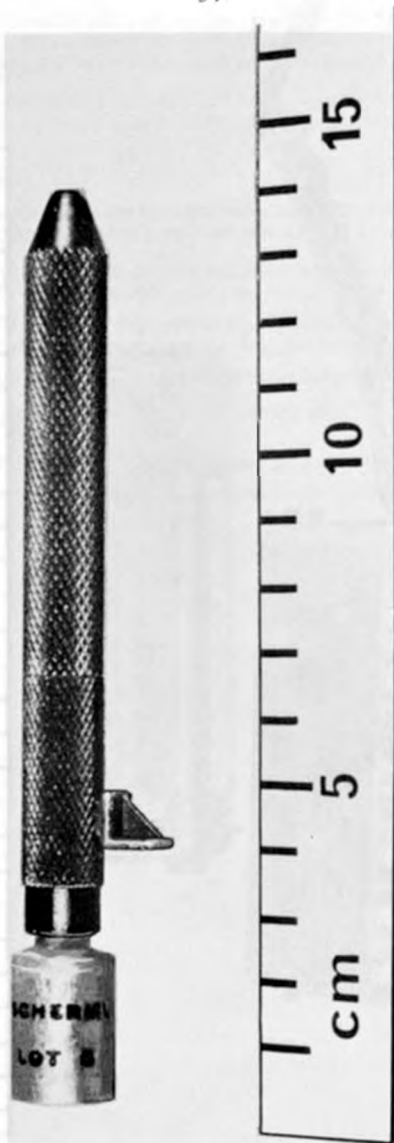

Fig 21. The pistol

If on active service it is necessary to destroy surplus weapons so that they become unusable by an enemy, the following actions will prove effective:—

- (a) Plug the barrel near the chamber or bury the muzzle in the ground; load, and fire by remote control from behind cover.
- (b) Strip, as far as possible; bury and/or scatter remaining parts over a wide area.
- (c) Retain essential parts of the mechanism that remain, such as usable firing pins, etc.
- (d) Do not neglect the disposal of spare parts.

Should the foregoing destruction drill not be possible, other methods must be devised, eg, destroying by explosive charges or fire; running over by vehicles; scattering components in rivers and undergrowth. Unfired ammunition can be destroyed by explosives using improvised demolition charges made up with grenades, bombs, etc.